

GloTek, Inc. www.globtek.com 186 Veterans Drive, Northvale, NJ 07647 Tel. (201) 784-1000 Fax (201) 784-0111	Drawing Title: GTM961800P18048-T3, Medical/ITE/Household use Power Supply, Efficiency Level: USA DOE Level VI / Eco-design Directive 2009/125/EC, (EU) 2019/1782, Case Color/Style: GlobTek Black, Desktop/External, Regulated Switchmode AC-DC Power Supply AC Adaptor, Input Rating: 100-240V~, 50-60Hz, IEC 60320/C14, Output Rating: 180W, 48.0V@3.75A, Output Configuration: 1500 mm, 18/1C + Shield Cond, UL 1185, 4 Pin Kycon Locking Plug or Equal, Ferrite: None, GlobTek Black, GT Cord # C21422, Pin Out: Pin 2,4: +V, Pin 1,3, Shell: -V, Blades/Input Cord: (Order Separately), Approvals: cETLus 60601-1-11; cETLus 60950-1; cETLus 60601-1 3rd; CB 60601-1-11; CB 60601-1; cETLus; S-Mark IEC/EN 60601-1; WEEE; Ukraine; PSE; VCCI; Level VI; China RoHS; CE; EAC; Class I; RoHS; CB 60950; CB 60335; CCC; CB 62368; S-Mark 60950; ETL 62368; Morocco; IP41; RCM;	
	Model No. GTM961800P18048-T3	
	Part No./Ordering No. TR9CX3750YL4IMR6B	Rev A

## REVISION HISTORY

REV	DESCRIPTION	SUB	DATE	APPROVED
A	Initial release		06/04/2018	QA

In Addition to GlobTek Inc.'s renewed ISO9001:2015 - Quality Management System Certification, GlobTek Inc. is now certified to:

ISO13485:2016 - Medical Devices Quality Management System Certification

ISO14001:2015 - Environmental Management System Certification

ISO Certificates are available online at <https://www.globtek.com/iso-certificates/>

### Customer Approval of Specification:

Please approve, sign and send back to GlobTek so we can complete order processing.

A delay in receipt of this form will delay delivery schedule.

Company Name:

Customer P/N:

Quote Number:

Date:

Authorized Representative Name:

Authorized Representative Signature:

The acceptance of this specification and use of the product described in this document indicates the acceptance and binding of the customer to Globtek terms and conditions, which supersede all other agreements, terms, and conditions (<https://en.globtek.com/terms-and-conditions/>).

The purchaser of this product (Customer) agrees that it is their sole responsibility to determine suitability/fitness of the product described in this specification for their application and to take precautions for protection against any hazards attendant to the handling and use of the product.

### Footnote:

GlobTek Inc. will not be liable for the safety and performance of these power supplies if unauthorized access and repair occurs. End user should consult applicable UL, CSA or EN standards for proper installation instruction.

### Limitation of Use:

GlobTek products are intended for use with commercial, medical, and/or industrial equipment only. GlobTek product are not authorized for use as mission critical components in life support hazardous environment, nuclear or aircraft applications without prior written approval from the CEO of GlobTek Inc.

Contents of this document are subject to change without prior notice.

<b>GlobTek, Inc.</b> www.globtek.com 186 Veterans Drive, Northvale, NJ 07647 Tel. (201) 784-1000 Fax (201) 784-0111	Drawing Title: GTM961800P18048-T3, Medical/ITE/Household use Power Supply, Efficiency Level: USA DOE Level VI / Eco-design Directive 2009/125/EC, (EU) 2019/1782, Case Color/Style: GlobTek Black, Desktop/External, Regulated Switchmode AC-DC Power Supply AC Adaptor, Input Rating: 100-240V~, 50-60Hz, IEC 60320/C14, Output Rating: 180W, 48.0V@3.75A, Output Configuration: 1500 mm, 18/1C + Shield Cond, UL 1185, 4 Pin Kycon Locking Plug or Equal, Ferrite: None, GlobTek Black, GT Cord # C21422, Pin Out: Pin 2,4: +V, Pin 1,3, Shell: -V, Blades/Input Cord: (Order Separately), Approvals: cETLus 60601-1-11; cETLus 60950-1; cETLus 60601-1 3rd; CB 60601-1-11; CB 60601-1; cETLus; S-Mark IEC/EN 60601-1; WEEE; Ukraine; PSE; VCCI; Level VI; China RoHS; CE; EAC; Class I; RoHS; CB 60950; CB 60335; CCC; CB 62368; S-Mark 60950; ETL 62368; Morocco; IP41; RCM;	
	Model No. GTM961800P18048-T3	
	Part No./Ordering No. TR9CX3750YL4IMR6B	Rev A

## POWER SUPPLY INFORMATION

TYPE:	Desktop/External
TECHNOLOGY:	Regulated Switchmode AC-DC Power Supply AC Adaptor
CASE COLOR:	GlobTek Black
NAMEPLATE RATED INPUT:	100-240V~, 50-60Hz, 2.2A
INPUT CONFIG:	IEC 60320/C14
WATTS:	180.0
VOLTS OUT:	48.0
CURRENT OUT (Amps):	3.75
INGRESS PROTECTION:	IP41
GROUNDING CONFIGURATION:	(F2) Isolated Functional Earth for GTM96 series, Improved EMC
OUTPUT CONNECTOR HOOK UP:	(A) 2 conductor cable, metallic conn shell to minus
EFFICIENCY LEVEL:	
OUTPUT CONFIGURATION:	1500 mm, 18/1C + Shield Cond, UL 1185, 4 Pin Kycon Locking Plug or Equal, Ferrite: None, GlobTek Black, GT Cord # C21422
OVERMOLDED:	Yes
CONNECTOR PIN OUT:	Pin 2,4: +V, Pin 1,3, Shell: -V
LABEL SPECS:	Standard GT,L-1186
SPECIAL BARCODE LABEL	
MATERIAL:	
PACK SPEC:	
USER MANUAL:	

### PROPRIETARY INFORMATION

PROPRIETARY OF GLOBTEK, INC. ANY REPRODUCTION, DISCLOSURE OR USE OF THIS DRAWING, IN WHOLE OR IN PART, IS HEREBY PROHIBITED EXCEPT AS SPECIFIED IN WRITING BY GLOBTEK, INC. © GlobTek, Inc. 2018 - 2020

<p>GlobTek, Inc.  www.globtek.com  186 Veterans Drive,  Northvale, NJ 07647  Tel. (201) 784-1000  Fax (201) 784-0111</p>	<p>Drawing Title: GTM961800P18048-T3, Medical/ITE/Household use Power Supply, Efficiency Level: USA DOE Level VI / Eco-design Directive 2009/125/EC, (EU) 2019/1782, Case Color/Style: GlobTek Black, Desktop/External, Regulated Switchmode AC-DC Power Supply AC Adaptor, Input Rating: 100-240V~, 50-60Hz, IEC 60320/C14 , Output Rating: 180W, 48.0V@3.75A, Output Configuration: 1500 mm, 18/1C + Shield Cond, UL 1185, 4 Pin Kycon Locking Plug or Equal, Ferrite: None, GlobTek Black, GT Cord # C21422, Pin Out: Pin 2,4: +V, Pin 1,3, Shell: -V, Blades/Input Cord: (Order Separately), Approvals: cETLus 60601-1-11; cETLus 60950-1; cETLus 60601-1 3rd; CB 60601-1-11; CB 60601-1; cETLus; S-Mark IEC/EN 60601-1; WEEE; Ukraine; PSE; VCCI; Level VI; China RoHS; CE; EAC; Class I; RoHS; CB 60950; CB 60335; CCC; CB 62368; S-Mark 60950; ETL 62368; Morocco; IP41; RCM;</p> <p>Model No. GTM961800P18048-T3</p> <p>Part No./Ordering No. TR9CX3750YL4IMR6B</p>
	<p>Rev A</p>

Notes/Modifications/Customizations (notes in this section supersede the values shown in the standard spec):  
DIMENSIONS ARE IN MM UNLESS SPECIFIED OTHERWISE.

GloBtek, Inc. www.globtek.com 186 Veterans Drive, Northvale, NJ 07647 Tel. (201) 784-1000 Fax (201) 784-0111	Drawing Title: GTM961800P18048-T3, Medical/ITE/Household use Power Supply, Efficiency Level: USA DOE Level VI / Eco-design Directive 2009/125/EC, (EU) 2019/1782, Case Color/Style: GlobTek Black, Desktop/External, Regulated Switchmode AC-DC Power Supply AC Adaptor, Input Rating: 100-240V~, 50-60Hz, IEC 60320/C14, Output Rating: 180W, 48.0V@3.75A, Output Configuration: 1500 mm, 18/1C + Shield Cond, UL 1185, 4 Pin Kycon Locking Plug or Equal, Ferrite: None, GlobTek Black, GT Cord # C21422, Pin Out: Pin 2,4: +V, Pin 1,3, Shell: -V, Blades/Input Cord: (Order Separately), Approvals: cETLus 60601-1-11; cETLus 60950-1; cETLus 60601-1 3rd; CB 60601-1-11; CB 60601-1; cETLus; S-Mark IEC/EN 60601-1; WEEE; Ukraine; PSE; VCCI; Level VI; China RoHS; CE; EAC; Class I; RoHS; CB 60950; CB 60335; CCC; CB 62368; S-Mark 60950; ETL 62368; Morocco; IP41; RCM;	
	Model No. GTM961800P18048-T3	
	Part No./Ordering No. TR9CX3750YL4IMR6B	Rev A

## ELECTRICAL SPECIFICATIONS

### A) ELECTRICAL SPECIFICATIONS:

01. Input Voltage: Specified 90-264 VAC, Nameplate rated: 100-240VAC  
90-264VAC range @ 100% of rated load current  
85-264 VAC range @ 90% of rated load current
02. Input Frequency: Specified 47-63Hz, Nameplate rated 50/60Hz
03. Power Factor: 0.90 (min.) @ 230VAC, 0.97 (min.) @ 115VAC
04. Output Regulation:  $\pm 4\%$  measured at the output connector
05. Line Voltage Regulation:  $\pm 0.5\%$  (typ.), measured at full load
06. Green Power-On Indicator LED
07. Output Ripple ( $V_p$ -p): 1% or 200 mV (whichever is greater), measured with a 0.1  $\mu$ F ceramic capacitor in parallel with a low-ESR 47 $\mu$ F electrolytic capacitor, connected at the output connector, with 20MHz bandwidth, at nominal line
08. Turn-On Delay: 1 second (typ.)
09. Turn-On Overshoot: 5% (max.)
10. Transient Response: 5% deviation, 1ms recovery, for 25% to 50% step load
11. Hold-Up Time: 20 ms (min.)
12. Inrush Current: 30A (max.) @ 115VAC, 60A (max.) @ 230VAC
13. Switching Frequency: Variable, 25KHz to 125KHz, depending on model and load condition
14. Efficiency: Compliant with DoE Efficiency Level VI and CoC Tier 2
15. No Load Standby Power: <0.15 W @ 230VAC

### B) PROTECTION

01. Input Protection: Dual input line fusing and 300VAC rated MOV
02. Short Circuit/Overload: Electronically protected unit will auto recover upon removal of fault  
Output Current Limit: Current limited to less than (240W / VNom) and 18A for low voltage models  
(VNom = nominal rated output voltage)
03. Over-Temperature: Latching electronic over-temperature protection, cycle AC on/off to reset.
04. Output Over-Voltage: 110% to 135% of nominal output voltage under full load condition, and less than 60V max. Latching protection, cycle AC on/off to reset.

### C) SAFETY

01. Dielectric Withstand Voltage:
    - a) All models: 4000VAC or 5656VDC (from input to output)
    - b) Class I models: 3000VAC or 4242VDC (from input to earth)
  02. Earth Leakage Current: Class I models < 300 $\mu$ A, N/A for Class II models
  03. Touch Current (Normal condition):
    - a) Standard models (No suffix):  
Class I: < 20 $\mu$ A  
Class II: < 70 $\mu$ A  
Class II with FE: < 20 $\mu$ A
    - b) Low-leakage models (-CF suffix):  
Class II with FE: < 10 $\mu$ A
- Note: Standard models are designed for use in Type-B/BF medical applications. Low-leakage models are designed for use in Type-CF medical applications. (See IEC60601-1, Clause 16.6.1)

### 04. Output Isolation Options:

- a) C8 or C18 Inlet, Class II

## PROPRIETARY INFORMATION

PROPRIETARY OF GLOBTEK, INC. ANY REPRODUCTION, DISCLOSURE OR USE OF THIS DRAWING, IN WHOLE OR IN PART, IS HEREBY PROHIBITED EXCEPT AS SPECIFIED IN

WRITING BY GLOBTEK, INC. © GlobTek, Inc. 2018 - 2020

quest/09/22/2020 11:14:08 PM CLONED FROM TR9C16666MF6C1MR6B

GloBtek, Inc. www.globtek.com 186 Veterans Drive, Northvale, NJ 07647 Tel. (201) 784-1000 Fax (201) 784-0111	Drawing Title: GTM961800P18048-T3, Medical/ITE/Household use Power Supply, Efficiency Level: USA DOE Level VI / Eco-design Directive 2009/125/EC, (EU) 2019/1782, Case Color/Style: GlobTek Black, Desktop/External, Regulated Switchmode AC-DC Power Supply AC Adaptor, Input Rating: 100-240V~, 50-60Hz, IEC 60320/C14, Output Rating: 180W, 48.0V@3.75A, Output Configuration: 1500 mm, 18/1C + Shield Cond, UL 1185, 4 Pin Kycon Locking Plug or Equal, Ferrite: None, GlobTek Black, GT Cord # C21422, Pin Out: Pin 2,4: +V, Pin 1,3, Shell: -V, Blades/Input Cord: (Order Separately), Approvals: cETLus 60601-1-11; cETLus 60950-1; cETLus 60601-1 3rd; CB 60601-1-11; CB 60601-1; cETLus; S-Mark IEC/EN 60601-1; WEEE; Ukraine; PSE; VCCI; Level VI; China RoHS; CE; EAC; Class I; RoHS; CB 60950; CB 60335; CCC; CB 62368; S-Mark 60950; ETL 62368; Morocco; IP41; RCM;	
	Model No. GTM961800P18048-T3	
	Part No./Ordering No. TR9CX3750YL4IMR6B	Rev A

- b) C6 or C14 Inlet, Class II with FE, Output isolated from earth contact
- c) C6 or C14 Inlet, Class I, Output negative directly attached to earth contact
- 05. Earth Continuity Test: < 0.1Ω between earth pin at AC input and PCB termination point (Class I models only)
- 06. Means of Protection: 2 x MOPP
- 07. Primary to Secondary Bridging Capacitance: Two IEC60384-14 certified Y1 type capacitors in series
- 08. Compliant Standards: See listings at end of this drawing for specifics
  
- D) EMC
  - EN 60601-1-2, 4th edition
  - Emissions, per EN 55032, EN 61000-6-3, EN 61000-6-4, CISPR11 and CISPR22
    - Conducted Emissions: Class B, FCC Part 15, Class B
    - Radiated Emissions: Class B, FCC Part 15, Class B
  - Line Frequency Harmonics EN61000-3-2, Class A
  - Voltage Fluctuations/Flicker EN61000-3-3
  
  - Immunity, per EN 55024, EN 61000-6-1, EN 61000-6-2
    - Static Discharge Immunity EN61000-4-2, 10KV Contact Discharge, 18KV air discharge
    - Radiated RF Immunity EN61000-4-3, 10V/m 80-2.7GHz, 80% 1KHz AM.
    - EFT/Burst Immunity EN61000-4-4, 4KV/100kHz.
    - Line Surge Immunity EN61000-4-5, 2KV differential, 4KV common-mode
    - Conducted RF Immunity EN61000-4-6, 3VRMS, 80% 1KHz AM
    - Power Frequency Magnetic Field Immunity EN61000-4-8, 3A/m
    - Voltage Dip Immunity EN61000-4-11, Criteria
  
- E) OTHER:
  - 01. MTBF: 1,000,000 Hours @ 40°C ambient temperature, full load
  - 02. Operating Temperature: -10°C to 40°C ambient temperature, full load
    - Regarding Operating Temperature,
      - a- See below derating table for output power capability at alternate temperature
      - b- Extended low end temperature range down to -40°C available as a custom option
  - 03. Humidity: 0% to 95% relative humidity, non-condensing
  - 04. Storage Temperature: -30°C to 80°C
  - 05. Cooling: Convection
  - 06. RoHS: Compliant with latest regulations, see approvals section below
  - 07. Operational Altitude: Up to 5000m
  
- F) DESKTOP STYLE ENCLOSURE
  - 01. Housing: High impact plastic, 94V0 polycarbonate, non-vented
  - 02. Size: 176.5 x 74 x 40 +/-1.0 mm
  - 03. Markings: Label or Laser printed
  - 04. AC Input mechanical options: Desktop C6, C8, C14 or C18 IEC Inlet.
  
- G) SPECIAL OPTIONS
  - 01. Custom cordsets, various cordage types, and connector types
  - 02. Custom markings
  - 03. Short term output surge power capability, for motor applications, and short term intermittent high power need applications. 300W for 1 second is available as a special design variant.
  - 04. Reduced touch current, for IEC60601-1 Type-CF applications. (Available in models with -CF suffix.)
  - 05. Tightened output voltage tolerance

GloTek, Inc. www.globtek.com 186 Veterans Drive, Northvale, NJ 07647 Tel. (201) 784-1000 Fax (201) 784-0111	Drawing Title: GTM961800P18048-T3, Medical/ITE/Household use Power Supply, Efficiency Level: USA DOE Level VI / Eco-design Directive 2009/125/EC, (EU) 2019/1782, Case Color/Style: GlobTek Black, Desktop/External, Regulated Switchmode AC-DC Power Supply AC Adaptor, Input Rating: 100-240V~, 50-60Hz, IEC 60320/C14 , Output Rating: 180W, 48.0V@3.75A, Output Configuration: 1500 mm, 18/1C + Shield Cond, UL 1185, 4 Pin Kycon Locking Plug or Equal, Ferrite: None, GlobTek Black, GT Cord # C21422, Pin Out: Pin 2,4: +V, Pin 1,3, Shell: -V, Blades/Input Cord: (Order Separately), Approvals: cETLus 60601-1-11; cETLus 60950-1; cETLus 60601-1 3rd; CB 60601-1-11; CB 60601-1; cETLus; S-Mark IEC/EN 60601-1; WEEE; Ukraine; PSE; VCCI; Level VI; China RoHS; CE; EAC; Class I; RoHS; CB 60950; CB 60335; CCC; CB 62368; S-Mark 60950; ETL 62368; Morocco; IP41; RCM;	
	Model No. GTM961800P18048-T3	
	Part No./Ordering No. TR9CX3750YL4IMR6B	Rev A

- 06. Reduced output ripple level
- 08. Reduced output power marking/rating
- 09. Improved reliability PCB laminate with plated through-holes for IPC610 Class 2 compliance
- 10. Special housing colors and cordset colors
- 11. LED lighting applications, Class C line harmonics
- 12. Constant current output, for VNom to 0.75 x VNom. Add "-CC" suffix to model number. Current level is custom selectable.
- 13. Back EMF applications, custom solutions. For unusual motor load apps and other high inductance reverse energy flow requirements
- 14. Improved ingress protection rating

#### H) OUTPUT CONNECTORS

Several output connector options are available with various output current ratings.

GlobTek can supply 10A rated 2.1mm and 2.5mm style DC Power Jacks, to complement our

10A output rated 2.1mm and 2.5mm DC power plugs used on our output cordsets.

Please visit <https://en.globtek.com/news/high-current-coaxial-barrel-plug-jacks-for-high-wattage-power-supplies> for a real time product offering of mating connectors.

TO ADDRESS SYSTEM-LEVEL EMI CONCERNS, FERRITE CHOKES/BEADS MAY BE ADDED/REVISED UPON REQUEST. A SAMPLE KIT OF GLOBTEK'S STANDARD FERRITES IS AVAILABLE UNDER GLOBTEK P/N: EMI-MITIGATION-KIT1

FOR ADDITIONAL INFORMATION, PLEASE READ OUR WHITE PAPER AT:

<https://en.globtek.com/technical-articles/ferrite-kit-radiated-emi-suppression-kit-for-globtek-power-supplies-cable-assemblies>

INGRESS PROTECTION: IP41

GlobTek, Inc.  
 www.globtek.com  
 186 Veterans Drive,  
 Northvale, NJ 07647  
 Tel. (201) 784-1000  
 Fax (201) 784-0111

Drawing Title: GTM961800P18048-T3, Medical/ITE/Household use Power Supply, Efficiency Level: USA DOE Level VI / Eco-design Directive 2009/125/EC, (EU) 2019/1782, Case Color/Style: GlobTek Black, Desktop/External, Regulated Switchmode AC-DC Power Supply AC Adaptor, Input Rating: 100-240V~, 50-60Hz, IEC 60320/C14, Output Rating: 180W, 48.0V@3.75A, Output Configuration: 1500 mm, 18/1C + Shield Cond, UL 1185, 4 Pin Kycon Locking Plug or Equal, Ferrite: None, GlobTek Black, GT Cord # C21422, Pin Out: Pin 2,4: +V, Pin 1,3, Shell: -V, Blades/Input Cord: (Order Separately), Approvals: cETLus 60601-1-11; cETLus 60950-1; cETLus 60601-1 3rd; CB 60601-1-11; CB 60601-1; cETLus; S-Mark IEC/EN 60601-1; WEEE; Ukraine; PSE; VCCI; Level VI; China RoHS; CE; EAC; Class I; RoHS; CB 60950; CB 60335; CCC; CB 62368; S-Mark 60950; ETL 62368; Morocco; IP41; RCM;

Model No. GTM961800P18048-T3

Part No./Ordering No. TR9CX3750YL4IMR6B

Rev A

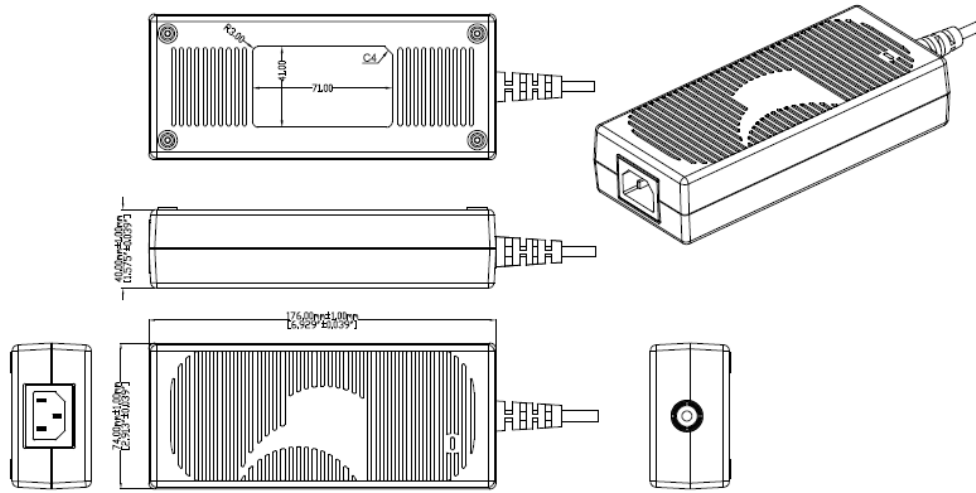

<p>GlobTek, Inc.  www.globtek.com  186 Veterans Drive,  Northvale, NJ 07647  Tel. (201) 784-1000  Fax (201) 784-0111</p>	<p>Drawing Title: GTM961800P18048-T3, Medical/ITE/Household use Power Supply, Efficiency Level: USA DOE Level VI / Eco-design Directive 2009/125/EC, (EU) 2019/1782, Case Color/Style: GlobTek Black, Desktop/External, Regulated Switchmode AC-DC Power Supply AC Adaptor, Input Rating: 100-240V~, 50-60Hz, IEC 60320/C14, Output Rating: 180W, 48.0V@3.75A, Output Configuration: 1500 mm, 18/1C + Shield Cond, UL 1185, 4 Pin Kycon Locking Plug or Equal, Ferrite: None, GlobTek Black, GT Cord # C21422, Pin Out: Pin 2,4: +V, Pin 1,3, Shell: -V, Blades/Input Cord: (Order Separately), Approvals: cETLus 60601-1-11; cETLus 60950-1; cETLus 60601-1 3rd; CB 60601-1-11; CB 60601-1; cETLus; S-Mark IEC/EN 60601-1; WEEE; Ukraine; PSE; VCCI; Level VI; China RoHS; CE; EAC; Class I; RoHS; CB 60950; CB 60335; CCC; CB 62368; S-Mark 60950; ETL 62368; Morocco; IP41; RCM;</p> <p>Model No. GTM961800P18048-T3</p> <p>Part No./Ordering No. TR9CX3750YL4IMR6B</p>	<p>Rev A</p>
--	--	--------------

### DERATING CURVE

#### TYPICAL EXTERNAL POWER SUPPLY DERATING CURVE

(FOR EFFICIENCY LEVEL V AND EFFICIENCY LEVEL VI PRODUCTS)

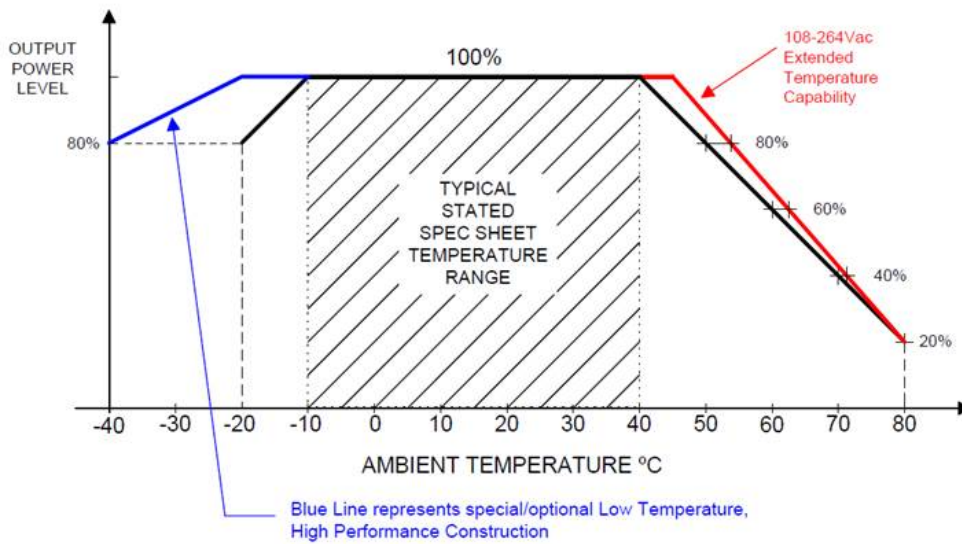



GloTek, Inc. www.globtek.com 186 Veterans Drive, Northvale, NJ 07647 Tel. (201) 784-1000 Fax (201) 784-0111	Drawing Title: GTM961800P18048-T3, Medical/ITE/Household use Power Supply, Efficiency Level: USA DOE Level VI / Eco-design Directive 2009/125/EC, (EU) 2019/1782, Case Color/Style: GlobTek Black, Desktop/External, Regulated Switchmode AC-DC Power Supply AC Adaptor, Input Rating: 100-240V~, 50-60Hz, IEC 60320/C14, Output Rating: 180W, 48.0V@3.75A, Output Configuration: 1500 mm, 18/1C + Shield Cond, UL 1185, 4 Pin Kycon Locking Plug or Equal, Ferrite: None, GlobTek Black, GT Cord # C21422, Pin Out: Pin 2,4: +V, Pin 1,3, Shell: -V, Blades/Input Cord: (Order Separately), Approvals: cETLus 60601-1-11; cETLus 60950-1; cETLus 60601-1 3rd; CB 60601-1-11; CB 60601-1; cETLus; S-Mark IEC/EN 60601-1; WEEE; Ukraine; PSE; VCCI; Level VI; China RoHS; CE; EAC; Class I; RoHS; CB 60950; CB 60335; CCC; CB 62368; S-Mark 60950; ETL 62368; Morocco; IP41; RCM;	
	Model No. GTM961800P18048-T3	
	Part No./Ordering No. TR9CX3750YL4IMR6B	Rev A

### INPUT CONFIGURATION

(F2) Isolated Functional Earth for GTM96 series, Improved EMC

GTM96XXX Optional Config

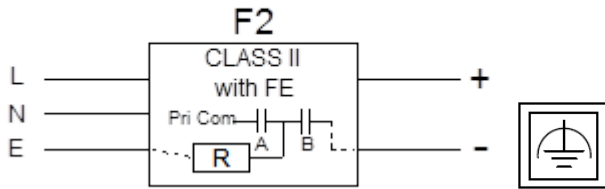

[Alternate grounding configurations](#) available upon request.

IEC 60320/C14 AC Inlet Connector, Class I, Earth Ground

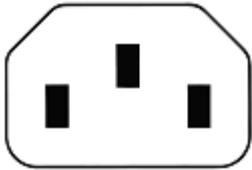

Mates with IEC 60320/C13 Plug

Optional Locking IEC60320 Receptacle and cord option available on some models by request.:

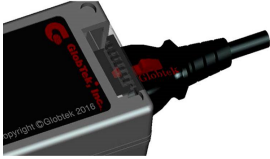

### [Standard International IEC 320/C13 Cordsets](#)

Below are standard cordsets which are "not included" (unless stated above); these can be purchased separately or packaged with the power supply. Contact your Sales Engineer if the style required is not shown below. Many more available in different lengths, colors or cable material.

### Stock Power Supply Cords

Part Number/ Link	Country	Plug	Termination	Length (mm)	(Ft)

#### PROPRIETARY INFORMATION

PROPRIETARY OF GLOBTEK, INC. ANY REPRODUCTION, DISCLOSURE OR USE OF THIS DRAWING, IN WHOLE OR IN PART, IS HEREBY PROHIBITED EXCEPT AS SPECIFIED IN

WRITING BY GLOBTEK, INC. © GlobTek, Inc. 2018 - 2020

quest /09/22/2020 11:14:08 PM CLONED FROM TR9C16666MF6CIMR6B

GloTek, Inc. www.globtek.com 186 Veterans Drive, Northvale, NJ 07647 Tel. (201) 784-1000 Fax (201) 784-0111	Drawing Title: GTM961800P18048-T3, Medical/ITE/Household use Power Supply, Efficiency Level: USA DOE Level VI / Eco-design Directive 2009/125/EC, (EU) 2019/1782, Case Color/Style: GlobTek Black, Desktop/External, Regulated Switchmode AC-DC Power Supply AC Adaptor, Input Rating: 100-240V~, 50-60Hz, IEC 60320/C14, Output Rating: 180W, 48.0V@3.75A, Output Configuration: 1500 mm, 18/1C + Shield Cond, UL 1185, 4 Pin Kycon Locking Plug or Equal, Ferrite: None, GlobTek Black, GT Cord # C21422, Pin Out: Pin 2,4: +V, Pin 1,3, Shell: -V, Blades/Input Cord: (Order Separately), Approvals: cETLus 60601-1-11; cETLus 60950-1; cETLus 60601-1 3rd; CB 60601-1-11; CB 60601-1; cETLus; S-Mark IEC/EN 60601-1; WEEE; Ukraine; PSE; VCCI; Level VI; China RoHS; CE; EAC; Class I; RoHS; CB 60950; CB 60335; CCC; CB 62368; S-Mark 60950; ETL 62368; Morocco; IP41; RCM;	
	Model No. GTM961800P18048-T3	
	Part No./Ordering No. TR9CX3750YL4IMR6B	Rev A

<a href="#">3021457F701(R)</a>	N. American (Type B)	NEMA 5-15P	IEC 320/C13	2150	7
<a href="#">1191068F0701(R)</a>	N. American (Type B)	NEMA 5-15P Hospital	IEC 320/C13	2459	8
<a href="#">2194272M5701-T(R)</a>	Argentina (Type I)	IRAM 2073	IEC 320/C13	2500	8
<a href="#">5502022M5701A(R)</a>	Australian (Type I)	AS3112 / 3 PRONG	IEC 320/C13	2500	8
<a href="#">204B4272M5701(R)</a>	Brazil (Type N)	BRAZIL	IEC 320/C13	2500	8
<a href="#">6023602M5701(R)</a>	China (Type I)	CCC GR2099	IEC 320/C13	2500	8
<a href="#">G8014272M5701(R)</a>	Danish (Type K)	AFSNIT SECTION 107-2-D1	IEC 320/C13	2500	8
<a href="#">23144272M5701-T(R)</a>	Europe (Type E)	CEE 7/7	IEC 320/C13	2500	8
<a href="#">205IN4272M5701(R)</a>	India (Type D)	India IS 1293 (also known as IA16A3 or BS546)	IEC 320/C13	2500	8
<a href="#">208IN4272M5701(R)</a>	India (Type M)	India IS 1293 (also known as IA16A3 or BS546)	IEC320/C13	2500	8
<a href="#">377C4272M5701(R)</a>	Israel (Type H)	ISL 377C	IEC 320/C13	2500	8
<a href="#">23024272M5701(R)</a>	Italy (Type L)	CEI 23-16/VII	IEC 320/C13	2500	8
<a href="#">3003339F701(R)</a> [3x1.25mm2]	Japan (Type B)	JIS 8303 / 3 PINS	IEC 320/C13	2500	8
<a href="#">3003068F2701-HK(R)</a> [3 x 2.0mm2]					
<a href="#">302J115J6F0701J(R)</a>	Japan / North America (Type B – 12A)	JIS 8303 / 3 PINS and NEMA 5-15P (PSE and UL/CUL appr)	IEC 320/C13	1830	6
<a href="#">302J104J6F0701J(R)</a>	Japan / North America (Type B – 15A)	JIS 8303 / 3 PINS and NEMA 5-15P (PSE and UL/CUL appr)	IEC 320/C13	1830	6
<a href="#">2313K3432M5701(R)</a>	Korea (Type F)	KS C 8305	IEC 320/C13	2500	8
<a href="#">5804272M5701(R)</a>	Russia (Type F)	GOST 7396	IEC 320/C13	2500	8
<a href="#">2084272M5701(R)</a>	South Africa (Type M)	South Africa SABS164-1 (16A type)	IEC 320/C13	2500	8
<a href="#">23214272M5701(R)</a>	Switzerland (Type J)	SEV 1011	IEC 320/C13	2500	8
<a href="#">3003322M5701(R)</a>	Taiwan (Type B)	BSMI	IEC 320/C13	2500	8
<a href="#">PZ0800100-2M5BK13H(R)</a>	UK, Hong Kong, Singapore, Gulf States (Type G)	BS 1363A	IEC 320/C13	2500	8
<a href="#">7055002M5701A(R)</a>	International	IEC 320 C14-C13	IEC 320/C13	2500	8

GlobTek, Inc. www.globtek.com 186 Veterans Drive, Northvale, NJ 07647 Tel. (201) 784-1000 Fax (201) 784-0111	Drawing Title: GTM961800P18048-T3, Medical/ITE/Household use Power Supply, Efficiency Level: USA DOE Level VI / Eco-design Directive 2009/125/EC, (EU) 2019/1782, Case Color/Style: GlobTek Black, Desktop/External, Regulated Switchmode AC-DC Power Supply AC Adaptor, Input Rating: 100-240V~, 50-60Hz, IEC 60320/C14, Output Rating: 180W, 48.0V@3.75A, Output Configuration: 1500 mm, 18/1C + Shield Cond, UL 1185, 4 Pin Kycon Locking Plug or Equal, Ferrite: None, GlobTek Black, GT Cord # C21422, Pin Out: Pin 2,4: +V, Pin 1,3, Shell: -V, Blades/Input Cord: (Order Separately), Approvals: cETLus 60601-1-11; cETLus 60950-1; cETLus 60601-1 3rd; CB 60601-1-11; CB 60601-1; cETLus; S-Mark IEC/EN 60601-1; WEEE; Ukraine; PSE; VCCI; Level VI; China RoHS; CE; EAC; Class I; RoHS; CB 60950; CB 60335; CCC; CB 62368; S-Mark 60950; ETL 62368; Morocco; IP41; RCM;	
	Model No. GTM961800P18048-T3	
	Part No./Ordering No. TR9CX3750YL4IMR6B	Rev A

**OUTPUT CORD AND CONNECTOR: YL4/C21422**

ACTUAL CONNECTORS, OVERMOLDS, FERRITES MAY VARY SLIGHTLY FROM THE PICTURE BELOW

CABLE TYPE	UL 1185
CABLE LENGTH (mm)	1500
CABLE TOLERANCE (mm)	+100, -0
WIRE GAUGE (AWG)	18
CONDUCTORS	1C + Shield
HANK DIMENSION (mm)	120 ± 10
CABLE / CONNECTOR OVERMOLD COLOR	GlobTek Black
FERRITE TYPE / DIMENSION	None
FERRITE # OF TURNS <a href="#">(Definition)</a>	N/A
FERRITE DIMENSION FROM STRAIN RELIEF	N/A
FERRITE DIMENSION FROM PLUG	N/A
PLUG TYPE	4 Pin Kycon Locking Plug or Equal
OUTPUT CONNECTOR GENDER	
OVERMOLDED	Yes
OVER MOLD ORIENTATION	Straight
CONNECTOR PIN OUT:	Pin 2,4: +V, Pin 1,3, Shell: -V
ADDITIONAL REQUIREMENTS	

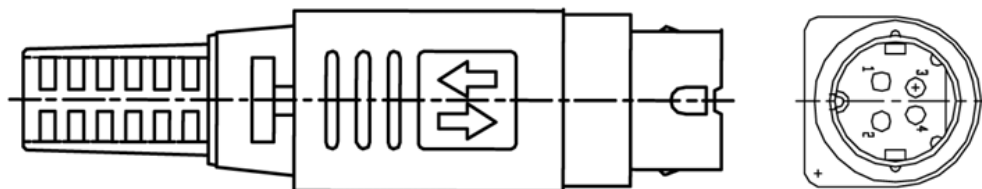

ADDITIONAL OUTPUT PLUG OPTIONS ARE AVAILABLE AT <https://www.globtek.com/connectors/>  
STANDARD PLUGS AND CONNECTORS CAN BE SEEN ONLINE AT <https://www.globtek.com/connectors/>  
CALCULATE VOLTAGE REGULATION/DROP WITH OUR ONLINE CALCULATOR: <https://en.globtek.com/output-cable-regulation-calculator/>

<p>GlobTek, Inc.  www.globtek.com  186 Veterans Drive,  Northvale, NJ 07647  Tel. (201) 784-1000  Fax (201) 784-0111</p>	<p>Drawing Title: GTM961800P18048-T3, Medical/ITE/Household use Power Supply, Efficiency Level: USA DOE Level VI / Eco-design Directive 2009/125/EC, (EU) 2019/1782, Case Color/Style: GlobTek Black, Desktop/External, Regulated Switchmode AC-DC Power Supply AC Adaptor, Input Rating: 100-240V~, 50-60Hz, IEC 60320/C14, Output Rating: 180W, 48.0V@3.75A, Output Configuration: 1500 mm, 18/1C + Shield Cond, UL 1185, 4 Pin Kycon Locking Plug or Equal, Ferrite: None, GlobTek Black, GT Cord # C21422, Pin Out: Pin 2,4: +V, Pin 1,3, Shell: -V, Blades/Input Cord: (Order Separately), Approvals: cETLus 60601-1-11; cETLus 60950-1; cETLus 60601-1 3rd; CB 60601-1-11; CB 60601-1; cETLus; S-Mark IEC/EN 60601-1; WEEE; Ukraine; PSE; VCCI; Level VI; China RoHS; CE; EAC; Class I; RoHS; CB 60950; CB 60335; CCC; CB 62368; S-Mark 60950; ETL 62368; Morocco; IP41; RCM;</p> <p>Model No. GTM961800P18048-T3</p> <p>Part No./Ordering No. TR9CX3750YL4IMR6B</p>	<p>Rev A</p>
--	--	--------------

### OUTPUT CONNECTOR HOOK UP

(A) 2 conductor cable, metallic conn shell to minus

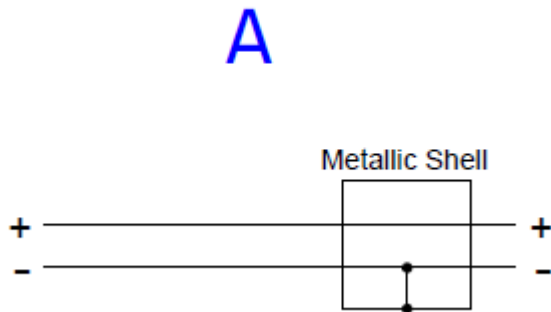

TO ADDRESS SYSTEM-LEVEL EMI CONCERNS, FERRITE CHOKES/BEADS MAY BE ADDED/REVISED UPON REQUEST. A SAMPLE KIT OF GLOBTEK'S STANDARD FERRITES IS AVAILABLE UNDER GLOBTEK P/N: EMI-MITIGATION-KIT1

FOR ADDITIONAL INFORMATION, PLEASE READ OUR WHITE PAPER AT:

<https://en.globtek.com/technical-articles/ferrite-kit-radiated-emi-suppression-kit-for-globtek-power-supplies-cable-assemblies>

GlobTek, Inc. www.globtek.com 186 Veterans Drive, Northvale, NJ 07647 Tel. (201) 784-1000 Fax (201) 784-0111	Drawing Title: GTM961800P18048-T3, Medical/ITE/Household use Power Supply, Efficiency Level: USA DOE Level VI / Eco-design Directive 2009/125/EC, (EU) 2019/1782, Case Color/Style: GlobTek Black, Desktop/External, Regulated Switchmode AC-DC Power Supply AC Adaptor, Input Rating: 100-240V~, 50-60Hz, IEC 60320/C14, Output Rating: 180W, 48.0V@3.75A, Output Configuration: 1500 mm, 18/1C + Shield Cond, UL 1185, 4 Pin Kycon Locking Plug or Equal, Ferrite: None, GlobTek Black, GT Cord # C21422, Pin Out: Pin 2,4: +V, Pin 1,3, Shell: -V, Blades/Input Cord: (Order Separately), Approvals: cETLus 60601-1-11; cETLus 60950-1; cETLus 60601-1 3rd; CB 60601-1-11; CB 60601-1; cETLus; S-Mark IEC/EN 60601-1; WEEE; Ukraine; PSE; VCCI; Level VI; China RoHS; CE; EAC; Class I; RoHS; CB 60950; CB 60335; CCC; CB 62368; S-Mark 60950; ETL 62368; Morocco; IP41; RCM;	
	Model No. GTM961800P18048-T3	
	Part No./Ordering No. TR9CX3750YL4IMR6B	Rev A

LABEL:L-1186

LABEL P/N:	Standard GT
MATERIAL:	Flat Thermal Transfer, Imprintable, Polyester Label and/or Pad Printed and/or Molded, and/or Laser Engraved in the case
BACKGROUND COLOR:	Black if housing is Black, White or Silver if housing is White or Gray.
TEXT COLOR:	White or Silver if label is Black Background for Black housing. Black if label is White or Silver background and Housing is White or Gray.
LABEL WIDTH (mm):	41
LABEL HEIGHT (mm):	71
SPECIAL BARCODE LABEL MATERIAL:	

Below is the minimum information which will appear on the label. NOTE: in the logo area additional/actual positioning of symbols and text is subjected to change as per agency updates/requirements or additional model approvals become available. Regulatory certifications/label markings may be in logo area on the label or molded into the case housing outside the label area. Information will be shown via label and/or pad printed and/or molded and/or laser engraved in the case. \* Date code markings at GlobTek option

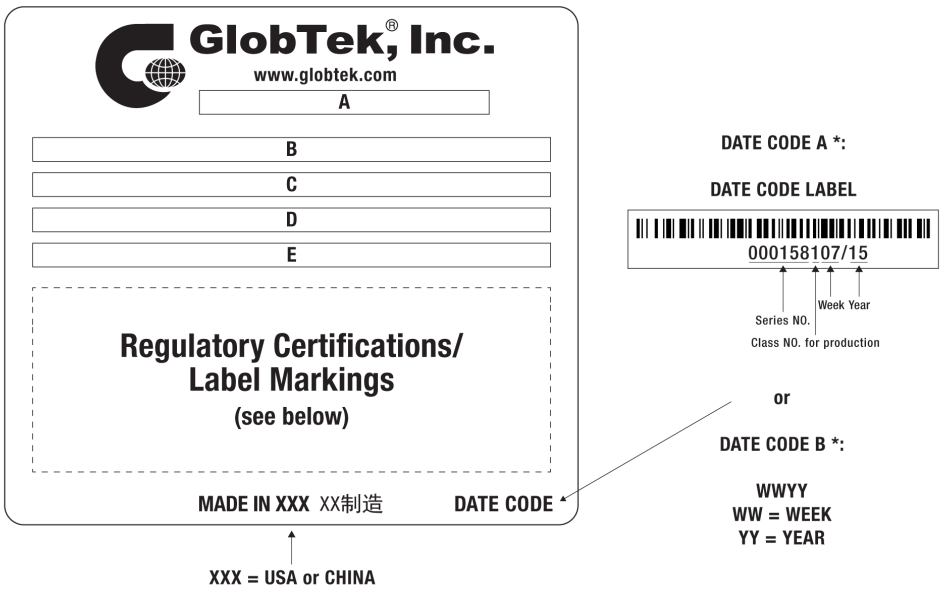

- A=Medical/ITE/Household use Power Supply
- B=P/N: (料号) TR9CX3750YL4IMR6B
- C=Model (型号) GTM961800P18048-T3
- D=Input (输入)100-240V~, 50-60Hz, 2.2A
- E=Output (输出)48.0 V --- 3.75 A, 180.0W

GloTek, Inc. www.globtek.com 186 Veterans Drive, Northvale, NJ 07647 Tel. (201) 784-1000 Fax (201) 784-0111	Drawing Title: GTM961800P18048-T3, Medical/ITE/Household use Power Supply, Efficiency Level: USA DOE Level VI / Eco-design Directive 2009/125/EC, (EU) 2019/1782, Case Color/Style: GlobTek Black, Desktop/External, Regulated Switchmode AC-DC Power Supply AC Adaptor, Input Rating: 100-240V~, 50-60Hz, IEC 60320/C14, Output Rating: 180W, 48.0V@3.75A, Output Configuration: 1500 mm, 18/1C + Shield Cond, UL 1185, 4 Pin Kycon Locking Plug or Equal, Ferrite: None, GlobTek Black, GT Cord # C21422, Pin Out: Pin 2,4: +V, Pin 1,3, Shell: -V, Blades/Input Cord: (Order Separately), Approvals: cETLus 60601-1-11; cETLus 60950-1; cETLus 60601-1 3rd; CB 60601-1-11; CB 60601-1; cETLus; S-Mark IEC/EN 60601-1; WEEE; Ukraine; PSE; VCCI; Level VI; China RoHS; CE; EAC; Class I; RoHS; CB 60950; CB 60335; CCC; CB 62368; S-Mark 60950; ETL 62368; Morocco; IP41; RCM;	
	Model No. GTM961800P18048-T3	
	Part No./Ordering No. TR9CX3750YL4IMR6B	Rev A

AGENCY ONLINE DOCUMENTS

<http://www.globtek.info/certs/GTM961800P/>

CE EC-Declaration for Medical

[http://globtek.force.com/models/ec\\_declaration\\_product?id=01t0c000008Oojr&m=1](http://globtek.force.com/models/ec_declaration_product?id=01t0c000008Oojr&m=1)

CE EC-Declaration for Industrial/Commercial/ITE

[http://globtek.force.com/models/ec\\_declaration\\_product?id=01t0c000008Oojr&i=2](http://globtek.force.com/models/ec_declaration_product?id=01t0c000008Oojr&i=2)

CE EC-Declaration for Household

[http://globtek.force.com/models/ec\\_declaration\\_product?id=01t0c000008Oojr&h=3](http://globtek.force.com/models/ec_declaration_product?id=01t0c000008Oojr&h=3)

UKCA-Declaration for Medical

UKCA-Declaration for Industrial/Commercial/ITE

UKCA-Declaration for Household

Morocco SDoC Declaration

[https://globtek.secure.force.com/models/Morocco\\_SDoC\\_Declaration?id=a000c000000ld6SEAR](https://globtek.secure.force.com/models/Morocco_SDoC_Declaration?id=a000c000000ld6SEAR)

RoHS/RoHS3 Declaration

[https://www.globtek.com/pdf/rohs\\_cert/01t0c000008OojrAAC](https://www.globtek.com/pdf/rohs_cert/01t0c000008OojrAAC)

REACH Declaration

[https://www.globtek.com/pdf/iso\\_certificates/REACH.pdf](https://www.globtek.com/pdf/iso_certificates/REACH.pdf)

Conflict Minerals Declaration

<https://www.globtek.com/pdf/conflict-minerals.pdf>

IPXY rating is based on 3rd party testing and customers should check suitability and test system level IPXY rating before ordering.

## Regulatory Certifications/Label Markings

LATEST PRODUCT/MODEL CERTIFICATIONS: <http://en.globtek.com/datasheet/id/a000c000000ld6S>

AGENCY ONLINE DOCUMENTS:

<http://www.globtek.info/certs/GTM961800P/>



(F2) Isolated Functional Earth for GTM96 series, Improved EMC

Front View



Pin 2,4: +V, Pin 1,3, Shell: -V

GloTek, Inc. www.globtek.com 186 Veterans Drive, Northvale, NJ 07647 Tel. (201) 784-1000 Fax (201) 784-0111	Drawing Title: GTM961800P18048-T3, Medical/ITE/Household use Power Supply, Efficiency Level: USA DOE Level VI / Eco-design Directive 2009/125/EC, (EU) 2019/1782, Case Color/Style: GlobTek Black, Desktop/External, Regulated Switchmode AC-DC Power Supply AC Adaptor, Input Rating: 100-240V~, 50-60Hz, IEC 60320/C14, Output Rating: 180W, 48.0V@3.75A, Output Configuration: 1500 mm, 18/1C + Shield Cond, UL 1185, 4 Pin Kycon Locking Plug or Equal, Ferrite: None, GlobTek Black, GT Cord # C21422, Pin Out: Pin 2,4: +V, Pin 1,3, Shell: -V, Blades/Input Cord: (Order Separately), Approvals: cETLus 60601-1-11; cETLus 60950-1; cETLus 60601-1 3rd; CB 60601-1-11; CB 60601-1; cETLus; S-Mark IEC/EN 60601-1; WEEE; Ukraine; PSE; VCCI; Level VI; China RoHS; CE; EAC; Class I; RoHS; CB 60950; CB 60335; CCC; CB 62368; S-Mark 60950; ETL 62368; Morocco; IP41; RCM;	
	Model No. GTM961800P18048-T3	
	Part No./Ordering No. TR9CX3750YL4IMR6B	Rev A

## PACKAGING

Packing Spec P/N:

Box Qty:	20
Gift Box Size (mm):	Cellular Packaging
Gift Box Color:	None
Master Carton Size (mm):	450 x 461 x 182
Master Carton Cubic Volume (m³):	0.04
Master GW (Kg):	16.0 kg
BLADES INCLUDED:	:
BLADE/CORD INSTALLED:	:
USER MANUAL*:	
USER MANUAL WEB LINK:	

\* This specification sheet is considered the user manual for all applications. It is expected that the buyer of this product will use it to formulate their own user manual for their end product and a user manual specifically for the power adapter is not usually required. If a user manual is not specifically listed above then none will be provided with this unit.

### PROPRIETARY INFORMATION

GloTek, Inc. www.globtek.com 186 Veterans Drive, Northvale, NJ 07647 Tel. (201) 784-1000 Fax (201) 784-0111	Drawing Title: GTM961800P18048-T3, Medical/ITE/Household use Power Supply, Efficiency Level: USA DOE Level VI / Eco-design Directive 2009/125/EC, (EU) 2019/1782, Case Color/Style: GlobTek Black, Desktop/External, Regulated Switchmode AC-DC Power Supply AC Adaptor, Input Rating: 100-240V~, 50-60Hz, IEC 60320/C14 , Output Rating: 180W, 48.0V@3.75A, Output Configuration: 1500 mm, 18/1C + Shield Cond, UL 1185, 4 Pin Kycon Locking Plug or Equal, Ferrite: None, GlobTek Black, GT Cord # C21422, Pin Out: Pin 2,4: +V, Pin 1,3, Shell: -V, Blades/Input Cord: (Order Separately), Approvals: cETLus 60601-1-11; cETLus 60950-1; cETLus 60601-1 3rd; CB 60601-1-11; CB 60601-1; cETLus; S-Mark IEC/EN 60601-1; WEEE; Ukraine; PSE; VCCI; Level VI; China RoHS; CE; EAC; Class I; RoHS; CB 60950; CB 60335; CCC; CB 62368; S-Mark 60950; ETL 62368; Morocco; IP41; RCM;	
	Model No. GTM961800P18048-T3	
	Part No./Ordering No. TR9CX3750YL4IMR6B	Rev A

## INSTRUCTIONS TO THE OEM SYSTEMS ENGINEER

It is the responsibility of the OEM systems engineer to provide the end system user instructions and warnings for the use of this product in the end system.

If an input cord is required for this product, AC Mains voltage should be provided to the power supply by a power supply cord approved to the national standards of the country in which it will be used.

This power supply is not designed to be repaired. No serviceable parts inside. A blown internal fuse is an indication of catastrophic failure of circuit component(s). If a Failure Analysis is required for a failed power supply/battery charger, please return the damaged unit to Globtek for an accurate determination of the root cause of the failure.

EMC Compliance of the complete OEM product, including the GlobTek power supply/battery charger needs to be verified by the OEM systems engineer.

## INSTRUCTION SHEET

N/A