

GloTek, Inc. www.globtek.com 186 Veterans Drive, Northvale, NJ 07647 Tel. (201) 784-1000 Fax (201) 784-0111	Drawing Title: GTM96600-6520-R3A, ITE / Medical Power Supply, Efficiency Level: VI, Case Color/Style: GlobTek Black, Wall Plug-in+Desktop Combination, Regulated Switchmode AC-DC Power Supply AC Adaptor, Input Rating: 100-240V~, 50-60 Hz, IEC 60320/C6 w/ Wall Blades Option , Output Rating: 65W, 20V@3.25A, Output Configuration: 1200 mm, 16/2 Cond, Round Black, T-plug system (includes 5.5x2.5, 5.5x2.1, 3.5x1.3mm plugs in each kit), Ferrite: Core Size: RH 14.2*28.5*10, GlobTek Black, GT Cord # C19381, Pin Out: Polarity Configuration T00 All plugs are Medical Grade, Locking, Polarized once installed, and single use only. Product demonstration link: <a href="https://en.globtek.com/news/t00-changeable-output-plug-system-for-power-supplies">https://en.globtek.com/news/t00-changeable-output-plug-system-for-power-supplies</a> MOLDED CONNECTORS AVAILABLE, Blades/Input Cord: R-Series Desktop Insert, Approvals: ETL; Korea (20.1V-28V Only); CE; China RoHS; Class I; Level VI; RoHS; Ukraine; VCCI; WEEE; PSE; PSE; PSE; FCC; S-Mark IEC/EN 60601-1; EAC; ETL; CB 60601-1; IP42; CB 62368; cETLus 60601; cETLus;	
	Model No. GTM96600-6520-R3A	
	Part No./Ordering No. RR9LZ3250T00-IMR6B	Rev B

## REVISION HISTORY

REV	DESCRIPTION	SUB	DATE	APPROVED
B	Update packing		08/06/2018	QA
A	Initial release		06/25/2018	QA

In Addition to GlobTek Inc.'s renewed ISO9001:2015 - Quality Management System Certification, GlobTek Inc. is now certified to:

ISO13485:2016 - Medical Devices Quality Management System Certification

ISO14001:2015 - Environmental Management System Certification

ISO Certificates are available online at <https://www.globtek.com/iso-certificates/>

### Customer Approval of Specification:

Please approve, sign and send back to GlobTek so we can complete order processing.

A delay in receipt of this form will delay delivery schedule.

Company Name:

Customer P/N:

Quote Number:

Date:

Authorized Representative Name:

Authorized Representative Signature:

The acceptance of this specification and use of the product described in this document indicates the acceptance and binding of the customer to Globtek terms and conditions, which supersede all other agreements, terms, and conditions (<https://en.globtek.com/terms-and-conditions/>).

### Footnote:

GlobTek Inc. will not be liable for the safety and performance of these power supplies if unauthorized access and repair occurs. End user should consult applicable UL, CSA or EN standards for proper installation instruction.

### Limitation of Use:

GlobTek products are intended for use with commercial, medical, and/or industrial equipment only. GlobTek product are not authorized for use as mission critical components in life support hazardous environment, nuclear or aircraft applications without prior written approval from the CEO of GlobTek Inc.

Contents of this document are subject to change without prior notice.

<b>GlobTek, Inc.</b> www.globtek.com 186 Veterans Drive, Northvale, NJ 07647 Tel. (201) 784-1000 Fax (201) 784-0111	Drawing Title: GTM96600-6520-R3A, ITE / Medical Power Supply, Efficiency Level: VI, Case Color/Style: GlobTek Black, Wall Plug-in+Desktop Combination, Regulated Switchmode AC-DC Power Supply AC Adaptor, Input Rating: 100-240V~, 50-60 Hz, IEC 60320/C6 w/ Wall Blades Option , Output Rating: 65W, 20V@3.25A, Output Configuration: 1200 mm, 16/2 Cond, Round Black, T-plug system (includes 5.5x2.5, 5.5x2.1, 3.5x1.3mm plugs in each kit), Ferrite: Core Size: RH 14.2*28.5*10, GlobTek Black, GT Cord # C19381, Pin Out: Polarity Configuration T00 All plugs are Medical Grade, Locking, Polarized once installed, and single use only. Product demonstration link: <a href="https://en.globtek.com/news/t00-changeable-output-plug-system-for-power-supplies MOLDED CONNECTORS AVAILABLE">https://en.globtek.com/news/t00-changeable-output-plug-system-for-power-supplies MOLDED CONNECTORS AVAILABLE</a> , Blades/Input Cord: R-Series Desktop Insert, Approvals: ETL; Korea (20.1V-28V Only); CE; China RoHS; Class I; Level VI; RoHS; Ukraine; VCCI; WEEE; PSE; PSE; PSE; FCC; S-Mark IEC/EN 60601-1; EAC; ETL; CB 60601-1; IP42; CB 62368; cETLus 60601; cETLus;	
	Model No. GTM96600-6520-R3A	
	Part No./Ordering No. RR9LZ3250T00-IMR6B	Rev B

## POWER SUPPLY INFORMATION

TYPE:	Wall Plug-in+Desktop Combination
TECHNOLOGY:	Regulated Switchmode AC-DC Power Supply AC Adaptor
CASE COLOR:	GlobTek Black
NAMEPLATE RATED INPUT:	100-240V~, 50-60 Hz, 1.5 A
INPUT CONFIG:	IEC 60320/C6 w/ Wall Blades Option
WATTS:	65.0
VOLTS OUT:	20
CURRENT OUT (Amps):	3.25
BLADE/CORD INCLUDED:	R-DI
BLADE/CORD INSTALLED:	R-DI
INGRESS PROTECTION:	IP40, IP54 Option available
GROUNDING CONFIGURATION:	(F2) Isolated Functional Earth for GTM96 series, Improved EMC
EFFICIENCY LEVEL:	VI
OUTPUT CONFIGURATION:	1200 mm, 16/2 Cond, Round Black, T-plug system (includes 5.5x2.5, 5.5x2.1, 3.5x1.3mm plugs in each kit), Ferrite: Core Size: RH 14.2*28.5*10, GlobTek Black, GT Cord # C19381
OVERMOLDED:	Yes
CONNECTOR PIN OUT:	Polarity Configuration T00 All plugs are Medical Grade, Locking, Polarized once installed, and single use only. Product demonstration link: <a href="https://en.globtek.com/news/t00-changeable-output-plug-system-for-power-supplies MOLDED CONNECTORS AVAILABLE">https://en.globtek.com/news/t00-changeable-output-plug-system-for-power-supplies MOLDED CONNECTORS AVAILABLE</a>
LABEL SPECS:	Standard GT,L-1186
SPECIAL BARCODE LABEL	
MATERIAL:	
PACK SPEC:	Packing for DT (hybrid) model with T00 plug and manual
USER MANUAL:	809-PSURKITUSERMANUAL on A4 paper

Notes/Modifications/Customizations (notes in this section supersede the values shown in the standard spec):

DIMENSIONS ARE IN MM UNLESS SPECIFIED OTHERWISE.

### PROPRIETARY INFORMATION

PROPRIETARY OF GLOBTEK, INC. ANY REPRODUCTION, DISCLOSURE OR USE OF THIS DRAWING, IN WHOLE OR IN PART, IS HEREBY PROHIBITED EXCEPT AS SPECIFIED IN

WRITING BY GLOBTEK, INC. © GlobTek, Inc. 2018 - 2019

quest /08/17/2019 5:05:24 PM CLONED FROM RR9LA6000SHY132(RVB)

GloBtek, Inc. www.globtek.com 186 Veterans Drive, Northvale, NJ 07647 Tel. (201) 784-1000 Fax (201) 784-0111	Drawing Title: GTM96600-6520-R3A, ITE / Medical Power Supply, Efficiency Level: VI, Case Color/Style: GlobTek Black, Wall Plug-in+Desktop Combination, Regulated Switchmode AC-DC Power Supply AC Adaptor, Input Rating: 100-240V~, 50-60 Hz, IEC 60320/C6 w/ Wall Blades Option , Output Rating: 65W, 20V@3.25A, Output Configuration: 1200 mm, 16/2 Cond, Round Black, T-plug system (includes 5.5x2.5, 5.5x2.1, 3.5x1.3mm plugs in each kit), Ferrite: Core Size: RH 14.2*28.5*10, GlobTek Black, GT Cord # C19381, Pin Out: Polarity Configuration T00 All plugs are Medical Grade, Locking, Polarized once installed, and single use only. Product demonstration link: https://en.globtek.com/news/t00-changeable-output-plug-system-for-power-supplies MOLDED CONNECTORS AVAILABLE, Blades/Input Cord: R-Series Desktop Insert, Approvals: ETL; Korea (20.1V-28V Only); CE; China RoHS; Class I; Level VI; RoHS; Ukraine; VCCI; WEEE; PSE; PSE; PSE; FCC; S-Mark IEC/EN 60601-1; EAC; ETL; CB 60601-1; IP42; CB 62368; cETLus 60601; cETLus;	
	Model No. GTM96600-6520-R3A	
	Part No./Ordering No. RR9LZ3250T00-IMR6B	Rev B

## ELECTRICAL SPECIFICATIONS

### A) ELECTRICAL SPECIFICATIONS:

01. Input Voltage: Specified 90-264 Vac, Nameplate rated: 100-240Vac
  - 90-264 Vac range @ 100% of rated load current
  - 85-264 Vac range @ 85% of rated load current
  - 110-370 VDC range @ 100% of rated load current
02. Input Frequency: Specified 47-63 Hz, Nameplate rated 50-60Hz
03. Output Regulation: +/- 5% measured at the output connector
04. Line Voltage Regulation: +/- 0.5% typical measured at full load
05. Green Power On Indicator LED
06. Output Ripple (Vp-p): 1% or 100 mV whichever is greater, measured at 20 MHz bandwidth with 0.1 uf ceramic capacitor in parallel with a low impedance 47 uf electrolytic capacitor connected at the end of the output connector
07. Turn-ON/OFF Overshoot: 5% maximum, 1 mS typical recovery time for 40% to 70% step load
08. Turn-ON Delay: 1 second maximum @ full load, nominal line
09. Hold-Up Time: 8 mS typical @ nominal input voltage and full load
10. Inrush Current: 30A/60A maximum cold start @ 115/230Vac input
11. Efficiency: Compliant with Efficiency Level VI and CoC Tier 2 standards
12. No Load Standby Power: <0.075 W @ 230Vac for <= 49W output power rating,  
<0.15W @ 230Vac for > 49W output power rating

### B) PROTECTION

01. Input Protection: Input line fusing and 300Vac MOV
02. Short Circuit/ Overload: Electronically Protected unit will auto recover upon removal of fault
  - Output Current Limit: 110% to 160% of rated output current
  - (upper end of current limit range is determined by normal output power rating, not derated output power level)
03. Output Over-Voltage: 110% to 130% of nominal output voltage

### C) SAFETY

01. Dielectric Withstand Voltage: 4000Vac or 5656Vdc from input to output, On Class I models, 3000Vac or 4242Vdc from input to earth
02. Earth Leakage Current: Class I models < 300uA, N/A for Class II models
03. Touch Current: Class I models < 20uA, Class II models < 85uA, F2 Models < 20uA
04. [Output Isolation Options](#):
  - a) C8 or C18 Inlet, Class II
  - b) C6 or C14 Inlet, Class II FE, Output Isolated from Earth contact
  - c) C6 or C14 Inlet, Class I, Output negative directly attached to Earth contact
05. Earth Continuity Test: < 0.1 Ohm between Earth Pin at AC input and PCB termination point (Class I models only)
06. Means of Protection: 2 x MOPP
07. Compliant Standards: See listings at end of this drawing for specifics

### D) EMC

- EN 60601-1-2, 4<sup>th</sup> edition  
Emissions, per EN 55032, EN 61000-6-3, EN 61000-6-4, CISPR11 and CISPR22  
Conducted Emissions: Class B, FCC Part 15, Class B  
Radiated Emissions: Class B, FCC Part 15, Class B  
Line Frequency Harmonics EN61000-3-2, Class A

#### PROPRIETARY INFORMATION

PROPRIETARY OF GLOBTEK, INC. ANY REPRODUCTION, DISCLOSURE OR USE OF THIS DRAWING, IN WHOLE OR IN PART, IS HEREBY PROHIBITED EXCEPT AS SPECIFIED IN

WRITING BY GLOBTEK, INC. © GlobTek, Inc. 2018 - 2019

quest/08/17/2019 5:05:24 PM CLONED FROM RR9LA6000SHY132(RVB)

GloBtek, Inc. www.globtek.com 186 Veterans Drive, Northvale, NJ 07647 Tel. (201) 784-1000 Fax (201) 784-0111	Drawing Title: GTM96600-6520-R3A, ITE / Medical Power Supply, Efficiency Level: VI, Case Color/Style: GlobTek Black, Wall Plug-in+Desktop Combination, Regulated Switchmode AC-DC Power Supply AC Adaptor, Input Rating: 100-240V~, 50-60 Hz, IEC 60320/C6 w/ Wall Blades Option , Output Rating: 65W, 20V@3.25A, Output Configuration: 1200 mm, 16/2 Cond, Round Black, T-plug system (includes 5.5x2.5, 5.5x2.1, 3.5x1.3mm plugs in each kit), Ferrite: Core Size: RH 14.2*28.5*10, GlobTek Black, GT Cord # C19381, Pin Out: Polarity Configuration T00 All plugs are Medical Grade, Locking, Polarized once installed, and single use only. Product demonstration link: <a href="https://en.globtek.com/news/t00-changeable-output-plug-system-for-power-supplies">https://en.globtek.com/news/t00-changeable-output-plug-system-for-power-supplies</a> MOLDED CONNECTORS AVAILABLE, Blades/Input Cord: R-Series Desktop Insert, Approvals: ETL; Korea (20.1V-28V Only); CE; China RoHS; Class I; Level VI; RoHS; Ukraine; VCCI; WEEE; PSE; PSE; PSE; FCC; S-Mark IEC/EN 60601-1; EAC; ETL; CB 60601-1; IP42; CB 62368; cETLus 60601; cETLus;	
	Model No. GTM96600-6520-R3A	
	Part No./Ordering No. RR9LZ3250T00-IMR6B	Rev B

#### Voltage Fluctuations/Flicker EN61000-3-3

Immunity, per EN 55024, EN 61000-6-1, EN 61000-6-2

Static Discharge Immunity EN61000-4-2, 10kV Contact Discharge, 20kV air discharge

Radiated RF Immunity EN61000-4-3, 10V/m 80-1000MHz, 3V/m 1-2.7GHz, 80% 1KHz AM.

EFT/Burst Immunity EN61000-4-4, 4kV/100kHz.

Line Surge Immunity EN61000-4-5, 2kV differential, 4kV common-mode

Conducted RF Immunity EN61000-4-6, 3Vrms, 80% 1KHz AM

Power Frequency Magnetic Field Immunity EN61000-4-8, 3A/m

Voltage Dip Immunity EN61000-4-11, Criteria

#### E) OTHER:

01. MTBF: 1,000,000 Hours @ 40°C ambient temperature, Full Load

02. GTM96600 Family: -20°C to 40°C ambient temperature with full load

Regarding Operating Temperature,

a- See below derating table for output power capability at alternate temperature

b- Extended low end temperature range available as custom option

03. Operating Humidity: 0% to 95% relative humidity, non-condensing

04. Storage Temperature: -30°C to 80°C

05. Operating Altitude: 5000 Meters

06. ROHS: Compliant with latest regulations, see approvals section below

#### F) ENCLOSURE

01. Housing: High impact plastic, 94V0 polycarbonate, non-vented

02. Markings: Label or Laser Printed

03. AC Input mechanical options: Desktop C6, C8, C14 or C18 IEC Inlet.

Hybrid option (Desktop or Changeable Blade Wall Plug-in) Class I or Class II input

#### G) SPECIAL OPTIONS

01. Cost reduction, removal of LED

02. Custom Cordsets, various cordage types, and connector types

03. Custom Markings

04. Short term Output Surge Capability for motor loads, and other high peak current loads. Available to 120W for 1 second, and higher levels possible for limited input voltage range, or allowed voltage dip.

05. Reduced Leakage Current versions

06. Tightened output voltage tolerance

07. Reduced output ripple level

08. Reduced output power rating marking

09. High Rel PCB laminate with Plated through Holes for IPC610 Class 2 Compliance

10. Low Temperature operation, down to -40°C

11. Special Housing Colors and Cordset Colors

12. Back EMF applications, custom solutions. For unusual motor load aps and other high inductance reverse energy flow requirements

13. Improved Ingress Protection Rating

#### H) OUTPUT CONNECTORS

Several output connector options are available with various output current ratings.

GloBtek can supply 10A rated 2.1mm and 2.5mm style DC Power Jacks, to complement our

10A output rated 2.1mm and 2.5mm DC power plugs used on our output cordsets.

Please visit <https://en.globtek.com/news/high-current-coaxial-barrel-plug-jacks-for-high-wattage-power-supplies> for a real time product offering of

#### PROPRIETARY INFORMATION

PROPRIETARY OF GLOBTEK, INC. ANY REPRODUCTION, DISCLOSURE OR USE OF THIS DRAWING, IN WHOLE OR IN PART, IS HEREBY PROHIBITED EXCEPT AS SPECIFIED IN

WRITING BY GLOBTEK, INC. © GlobTek, Inc. 2018 - 2019

quest /08/17/2019 5:05:24 PM CLONED FROM RR9LA6000SHY132(RVB)

GlobTek, Inc.  
 www.globtek.com  
 186 Veterans Drive,  
 Northvale, NJ 07647  
 Tel. (201) 784-1000  
 Fax (201) 784-0111

Drawing Title: GTM96600-6520-R3A, ITE / Medical Power Supply, Efficiency Level: VI, Case Color/Style: GlobTek Black, Wall Plug-in+Desktop Combination, Regulated Switchmode AC-DC Power Supply AC Adaptor, Input Rating: 100-240V~, 50-60 Hz, IEC 60320/C6 w/ Wall Blades Option , Output Rating: 65W, 20V@3.25A, Output Configuration: 1200 mm, 16/2 Cond, Round Black, T-plug system (includes 5.5x2.5, 5.5x2.1, 3.5x1.3mm plugs in each kit), Ferrite: Core Size: RH 14.2\*28.5\*10, GlobTek Black, GT Cord # C19381, Pin Out: Polarity Configuration T00 All plugs are Medical Grade, Locking, Polarized once installed, and single use only. Product demonstration link: <https://en.globtek.com/news/t00-changeable-output-plug-system-for-power-supplies> MOLDED CONNECTORS AVAILABLE, Blades/Input Cord: R-Series Desktop Insert, Approvals: ETL; Korea (20.1V-28V Only); CE; China RoHS; Class I; Level VI; RoHS; Ukraine; VCCI; WEEE; PSE; PSE; PSE; FCC; S-Mark IEC/EN 60601-1; EAC; ETL; CB 60601-1; IP42; CB 62368; cETLus 60601; cETLus;

Model No. GTM96600-6520-R3A

Part No./Ordering No. RR9LZ3250T00-IMR6B

Rev B

mating connectors.

INGRESS PROTECTION: IP40, IP54 Option available

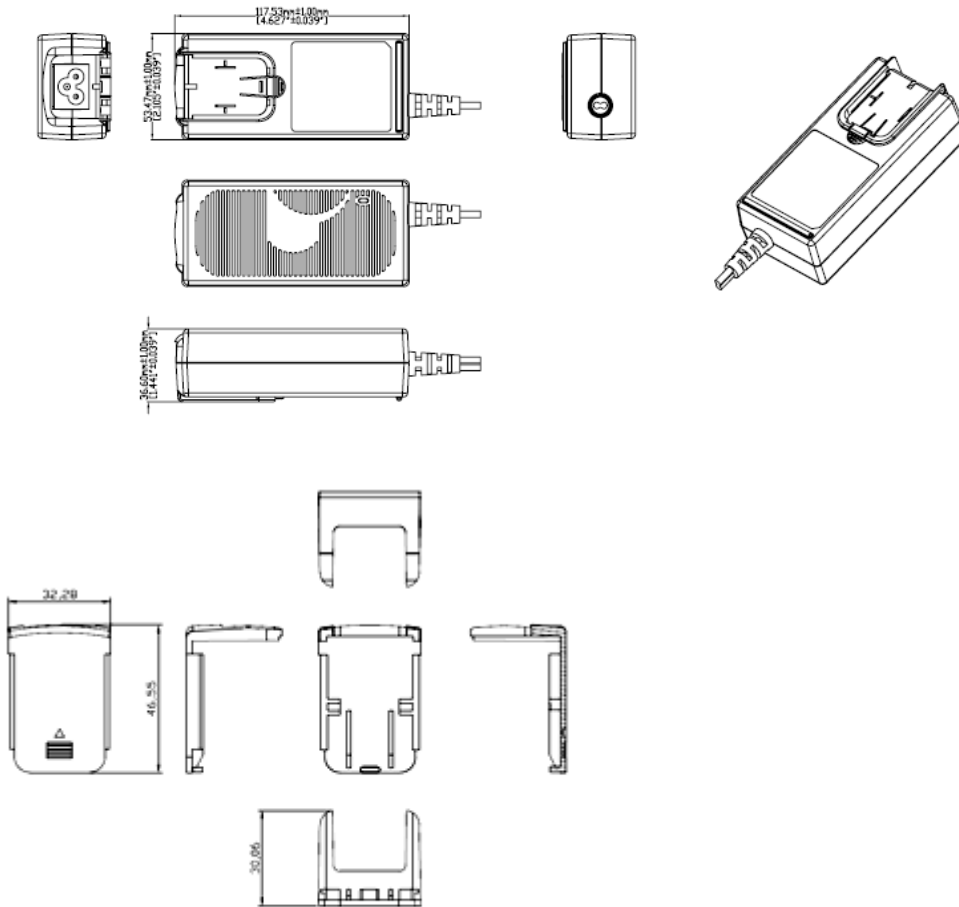

Units shipped without an installed input plug have a "desktop insert" installed.

DERATING CURVE

GlobTek, Inc.  
 www.globtek.com  
 186 Veterans Drive,  
 Northvale, NJ 07647  
 Tel. (201) 784-1000  
 Fax (201) 784-0111

Drawing Title: GTM96600-6520-R3A, ITE / Medical Power Supply, Efficiency Level: VI, Case Color/Style: GlobTek Black, Wall Plug-in+Desktop Combination, Regulated Switchmode AC-DC Power Supply AC Adaptor, Input Rating: 100-240V~, 50-60 Hz, IEC 60320/C6 w/ Wall Blades Option , Output Rating: 65W, 20V@3.25A, Output Configuration: 1200 mm, 16/2 Cond, Round Black, T-plug system (includes 5.5x2.5, 5.5x2.1, 3.5x1.3mm plugs in each kit), Ferrite: Core Size: RH 14.2\*28.5\*10, GlobTek Black, GT Cord # C19381, Pin Out: Polarity Configuration T00 All plugs are Medical Grade, Locking, Polarized once installed, and single use only. Product demonstration link: <https://en.globtek.com/news/t00-changeable-output-plug-system-for-power-supplies> MOLDED CONNECTORS AVAILABLE, Blades/Input Cord: R-Series Desktop Insert, Approvals: ETL; Korea (20.1V-28V Only); CE; China RoHS; Class I; Level VI; RoHS; Ukraine; VCCI; WEEE; PSE; PSE; PSE; FCC; S-Mark IEC/EN 60601-1; EAC; ETL; CB 60601-1; IP42; CB 62368; cETLus 60601; cETLus;

Model No. GTM96600-6520-R3A

Part No./Ordering No. RR9LZ3250T00-IMR6B

Rev B

### TYPICAL EXTERNAL POWER SUPPLY DERATING CURVE

(FOR EFFICIENCY LEVEL V AND EFFICIENCY LEVEL VI PRODUCTS)

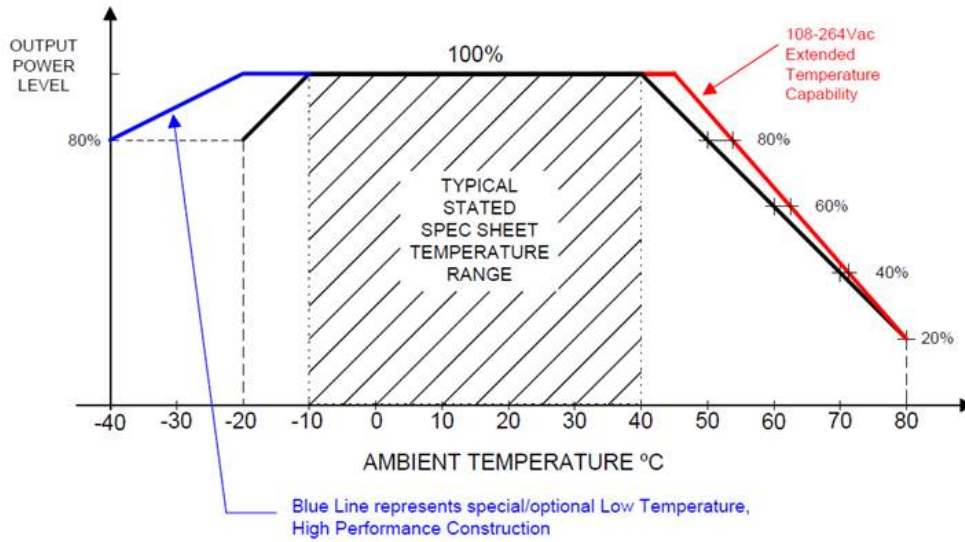

PROPRIETARY INFORMATION

PROPRIETARY OF GLOBTEK, INC. ANY REPRODUCTION, DISCLOSURE OR USE OF THIS DRAWING, IN WHOLE OR IN PART, IS HEREBY PROHIBITED EXCEPT AS SPECIFIED IN WRITING BY GLOBTEK, INC. © GlobTek, Inc. 2018 - 2019

GloTek, Inc. www.globtek.com 186 Veterans Drive, Northvale, NJ 07647 Tel. (201) 784-1000 Fax (201) 784-0111	Drawing Title: GTM96600-6520-R3A, ITE / Medical Power Supply, Efficiency Level: VI, Case Color/Style: GlobTek Black, Wall Plug-in+Desktop Combination, Regulated Switchmode AC-DC Power Supply AC Adaptor, Input Rating: 100-240V~, 50-60 Hz, IEC 60320/C6 w/ Wall Blades Option , Output Rating: 65W, 20V@3.25A, Output Configuration: 1200 mm, 16/2 Cond, Round Black, T-plug system (includes 5.5x2.5, 5.5x2.1, 3.5x1.3mm plugs in each kit), Ferrite: Core Size: RH 14.2*28.5*10, GlobTek Black, GT Cord # C19381, Pin Out: Polarity Configuration T00 All plugs are Medical Grade, Locking, Polarized once installed, and single use only. Product demonstration link: https://en.globtek.com/news/t00-changeable-output-plug-system-for-power-supplies MOLDED CONNECTORS AVAILABLE, Blades/Input Cord: R-Series Desktop Insert, Approvals: ETL; Korea (20.1V-28V Only); CE; China RoHS; Class I; Level VI; RoHS; Ukraine; VCCI; WEEE; PSE; PSE; PSE; FCC; S-Mark IEC/EN 60601-1; EAC; ETL; CB 60601-1; IP42; CB 62368; cETLus 60601; cETLus;	
	Model No. GTM96600-6520-R3A	
	Part No./Ordering No. RR9LZ3250T00-IMR6B	Rev B

## INPUT CONFIGURATION

(F2) Isolated Functional Earth for GTM96 series, Improved EMC

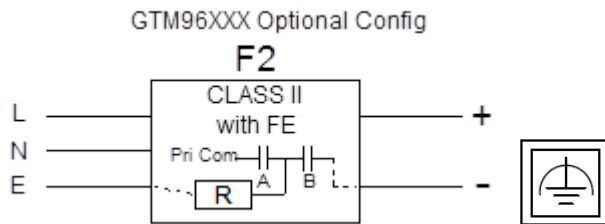

[Alternate grounding configurations](#) available upon request.

Blades/Cord Included:R-DI:

Blades/Cord Installed:R-DI:

IEC 60320/C6 AC Inlet Connector, Class I, Earth Ground ( aka "Mickey Mouse")

[Blade Insertion Instructions](#)

[R-Blade Style Instruction Video](#)

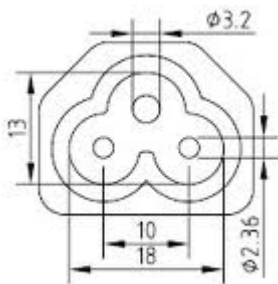

Mates with IEC 60320/C5 Plug

This series of Interchangeable Blade products may be used with Proprietary Interchangeable Blades as described below or with standard international power cords.

Optional INPUT BLADES: R-Socket: below are available blades configurations which are "not included" (unless stated above); may be purchased separately, packaged with power supply, or as a separate "R-KIT" if specified

1. Class I model NEMA 5-15P, Class I AC power plug with 2 blades & ground pin, R-NA-3(R)
2. Australian AS 3112 configuration: SAA 3 pins Class I, R-SAA-3(R)
3. UK BS 1363 configuration: UK 3 pins (Ground) Class I, R-UK-3(R)
4. European CEE 7/7 configuration: European plug 2 PINS + ground, Class I, R-EU-3(R)
5. Desktop Insert

Kits

### PROPRIETARY INFORMATION

PROPRIETARY OF GLOBTEK, INC. ANY REPRODUCTION, DISCLOSURE OR USE OF THIS DRAWING, IN WHOLE OR IN PART, IS HEREBY PROHIBITED EXCEPT AS SPECIFIED IN WRITING BY GLOBTEK, INC. © GlobTek, Inc. 2018 - 2019

quest /08/17/2019 5:05:24 PM CLONED FROM RR9LA6000SHY132(RVB)

GloBtek, Inc. www.globtek.com 186 Veterans Drive, Northvale, NJ 07647 Tel. (201) 784-1000 Fax (201) 784-0111	Drawing Title: GTM96600-6520-R3A, ITE / Medical Power Supply, Efficiency Level: VI, Case Color/Style: GlobTek Black, Wall Plug-in+Desktop Combination, Regulated Switchmode AC-DC Power Supply AC Adaptor, Input Rating: 100-240V~, 50-60 Hz, IEC 60320/C6 w/ Wall Blades Option , Output Rating: 65W, 20V@3.25A, Output Configuration: 1200 mm, 16/2 Cond, Round Black, T-plug system (includes 5.5x2.5, 5.5x2.1, 3.5x1.3mm plugs in each kit), Ferrite: Core Size: RH 14.2*28.5*10, GlobTek Black, GT Cord # C19381, Pin Out: Polarity Configuration T00 All plugs are Medical Grade, Locking, Polarized once installed, and single use only. Product demonstration link: https://en.globtek.com/news/t00-changeable-output-plug-system-for-power-supplies MOLDED CONNECTORS AVAILABLE, Blades/Input Cord: R-Series Desktop Insert, Approvals: ETL; Korea (20.1V-28V Only); CE; China RoHS; Class I; Level VI; RoHS; Ukraine; VCCI; WEEE; PSE; PSE; PSE; FCC; S-Mark IEC/EN 60601-1; EAC; ETL; CB 60601-1; IP42; CB 62368; cETLus 60601; cETLus;	
	Model No. GTM96600-6520-R3A	
	Part No./Ordering No. RR9LZ3250T00-IMR6B	Rev B

05. R-3-KIT: 1,2,3,4 above

06. R-3-KIT-INTL: 2,3,4 above

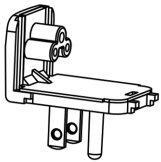

### UL 3P

P/N: R-NA-3(R)  
NORTH AMERICA  
JAPAN

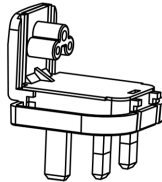

### UK 3P

P/N: R-UK-3(R)  
UNITED KINGDOM  
HONG KONG  
SINGAPORE

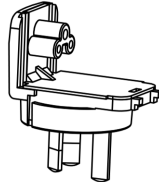

### AUS 3P

P/N: R-SAA-3(R)  
AUSTRALIA

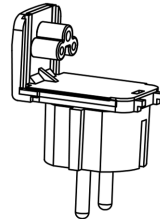

### EU 3P

P/N: R-EU-3(R)  
EUROPE  
SOUTH AMERICA

Below are standard cordsets which are "not included" (unless stated above); these can be purchased separately or package with the power supply. Contact your Sales Engineer if the style required is not shown below. Many more available in different lengths, colors or cable material.

#### Standard International IEC 320/C5 Cordsets

Part Number / Link	Country	Plug	Connector	Length (mm)	Length (ft)
<a href="#">3021066F712(R)</a>	N. American (Type B)	NEMA 5-15P	IEC 320/C5	1880	6
<a href="#">1191068F0712(R)</a>	N. American (Type B)	NEMA 5-15P Hospital	IEC 320/C5	2459	8
<a href="#">2194262M0712(R)</a>	Argentina (Type I)	IRAM 2073	IEC320/C5	2050	6.7
<a href="#">2064262M0712(R)</a>	Australian (Type I)	AS3112 / 3 PRONG	IEC 320/C5	2000	6.6
<a href="#">204B4262M0712(R)</a>	Brazil (Type N)	BRAZIL	IEC 320/C5	2000	6.6
<a href="#">6023592M5712(R)</a>	China (Type I)	CCC GR2099	IEC 320/C5	2500	8
<a href="#">23144262M0712(R)</a>	Europe (Type E)	CEE 7/7	IEC 320/C5	2050	6.6
<a href="#">2313K3432M0712(R)</a>	Korea (Type F)	KS C 8305	IEC 320/C5	2000	6.6
<a href="#">205IN4262M0712(R)</a>	India (Type D)	India IS 1293 (also known as IA16A3 or BS546)	IEC320/C5	2000	6.6

#### PROPRIETARY INFORMATION

PROPRIETARY OF GLOBTEK, INC. ANY REPRODUCTION, DISCLOSURE OR USE OF THIS DRAWING, IN WHOLE OR IN PART, IS HEREBY PROHIBITED EXCEPT AS SPECIFIED IN WRITING BY GLOBTEK, INC. © GlobTek, Inc. 2018 - 2019



GloTek, Inc. www.globtek.com 186 Veterans Drive, Northvale, NJ 07647 Tel. (201) 784-1000 Fax (201) 784-0111	Drawing Title: GTM96600-6520-R3A, ITE / Medical Power Supply, Efficiency Level: VI, Case Color/Style: GlobTek Black, Wall Plug-in+Desktop Combination, Regulated Switchmode AC-DC Power Supply AC Adaptor, Input Rating: 100-240V~, 50-60 Hz, IEC 60320/C6 w/ Wall Blades Option , Output Rating: 65W, 20V@3.25A, Output Configuration: 1200 mm, 16/2 Cond, Round Black, T-plug system (includes 5.5x2.5, 5.5x2.1, 3.5x1.3mm plugs in each kit), Ferrite: Core Size: RH 14.2*28.5*10, GlobTek Black, GT Cord # C19381, Pin Out: Polarity Configuration T00 All plugs are Medical Grade, Locking, Polarized once installed, and single use only. Product demonstration link: https://en.globtek.com/news/t00-changeable-output-plug-system-for-power-supplies MOLDED CONNECTORS AVAILABLE, Blades/Input Cord: R-Series Desktop Insert, Approvals: ETL; Korea (20.1V-28V Only); CE; China RoHS; Class I; Level VI; RoHS; Ukraine; VCCI; WEEE; PSE; PSE; PSE; FCC; S-Mark IEC/EN 60601-1; EAC; ETL; CB 60601-1; IP42; CB 62368; cETLus 60601; cETLus;	
	Model No. GTM96600-6520-R3A	
	Part No./Ordering No. RR9LZ3250T00-IMR6B	Rev B

<a href="#">377C4262M0712(R)</a>	Israel (Type H)	ISL	IEC320/C5 2050	6.7
<a href="#">23024262M0712(R)</a>	Italy (Type L)	CEI 23-16/VII	IEC 320/C5 2000	6.6
<a href="#">3003316F0712(R)</a>	Japan (Type B)	JIS 8303 / 3 PINS	IEC 320/C5 1830	6
<a href="#">3021066F0712ULPSE(R)</a>	Japan / USA (Type B)	JIS 8303 / 3 PINS + NEMA 5-15P	IEC 320/C5 1830	6
<a href="#">2054262M0712(R)</a>	S. Africa (Type D)	South Africa SABS164-1 (6A type plug)	IEC320/C5 2050	6.7
<a href="#">2084262M0712(R)</a>	S.Africa (Type M)	South Africa SABS164-1 (16A type plug)	IEC 320/C5 2000	6.6
<a href="#">23214262M0712(R)</a>	Switzerland (Type J)	SEV 1011 ( EL 203)	IEC 320/C5 2000	6.6
<a href="#">3003316F0712(R)</a>	Taiwan (Type B)	BSMI	IEC 320/C5 2000	6.6
<a href="#">6104262M0712(R)</a>	UK, Hong Kong, Singapore, Gulf States (Type G)	BS1363	IEC 320/C5 2000	6.6

GloTek, Inc. www.globtek.com 186 Veterans Drive, Northvale, NJ 07647 Tel. (201) 784-1000 Fax (201) 784-0111	Drawing Title: GTM96600-6520-R3A, ITE / Medical Power Supply, Efficiency Level: VI, Case Color/Style: GlobTek Black, Wall Plug-in+Desktop Combination, Regulated Switchmode AC-DC Power Supply AC Adaptor, Input Rating: 100-240V~, 50-60 Hz, IEC 60320/C6 w/ Wall Blades Option , Output Rating: 65W, 20V@3.25A, Output Configuration: 1200 mm, 16/2 Cond, Round Black, T-plug system (includes 5.5x2.5, 5.5x2.1, 3.5x1.3mm plugs in each kit), Ferrite: Core Size: RH 14.2*28.5*10, GlobTek Black, GT Cord # C19381, Pin Out: Polarity Configuration T00 All plugs are Medical Grade, Locking, Polarized once installed, and single use only. Product demonstration link: <a href="https://en.globtek.com/news/t00-changeable-output-plug-system-for-power-supplies">https://en.globtek.com/news/t00-changeable-output-plug-system-for-power-supplies</a> MOLDED CONNECTORS AVAILABLE, Blades/Input Cord: R-Series Desktop Insert, Approvals: ETL; Korea (20.1V-28V Only); CE; China RoHS; Class I; Level VI; RoHS; Ukraine; VCCI; WEEE; PSE; PSE; PSE; FCC; S-Mark IEC/EN 60601-1; EAC; ETL; CB 60601-1; IP42; CB 62368; cETLus 60601; cETLus;	
	Model No. GTM96600-6520-R3A	
	Part No./Ordering No. RR9LZ3250T00-IMR6B	Rev B

**OUTPUT CORD AND CONNECTOR: T00/C19381**

ACTUAL CONNECTORS, OVERMOLDS, FERRITES MAY VARY SLIGHTLY FROM THE PICTURE BELOW

CABLE TYPE	Round Black
CABLE LENGTH (mm)	1200
CABLE TOLERANCE (mm)	± 50
WIRE GAUGE (AWG)	16
CONDUCTORS	2
HANK DIMENSION (mm)	80 ± 10
CABLE / CONNECTOR OVERMOLD COLOR	GlobTek Black
FERRITE TYPE / DIMENSION	Core Size: RH 14.2*28.5*10
FERRITE # OF TURNS <a href="#">(Definition)</a>	2 Pass thru core (1 turns)
FERRITE DIMENSION FROM STRAIN RELIEF	50 ± 10
FERRITE DIMENSION FROM PLUG	N/A
PLUG TYPE	T-plug system (includes 5.5x2.5, 5.5x2.1, 3.5x1.3mm plugs in each kit)
OUTPUT CONNECTOR SEX	
OVERMOLDED	Yes
OVER MOLD ORIENTATION	Straight
	Polarity Configuration T00 All plugs are Medical Grade, Locking, Polarized once installed, and single use only.
CONNECTOR PIN OUT:	Product demonstration link: <a href="https://en.globtek.com/news/t00-changeable-output-plug-system-for-power-supplies">https://en.globtek.com/news/t00-changeable-output-plug-system-for-power-supplies</a> MOLDED CONNECTORS AVAILABLE

**ADDITIONAL REQUIREMENTS**

This novel system allows for rapid shipment of prototype samples or small quantities of common output voltage and current which can fulfill the needs of most common barrel plug specs. The table below explains the standard and non standard options available as part of this system. This system also allows for both Center Positive and Center Negative polarity.

The T00 plug and adapters are Medical Grade, single use only, Polarized after installation, and not removable without use of special tool.

Any of the below options, and more, are available as molded plugs from stock or special order. Please contact GlobTek for more information.

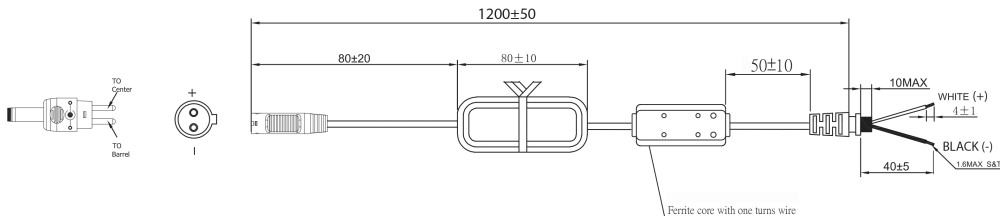

**PROPRIETARY INFORMATION**

GloTek, Inc. www.globtek.com 186 Veterans Drive, Northvale, NJ 07647 Tel. (201) 784-1000 Fax (201) 784-0111	Drawing Title: GTM96600-6520-R3A, ITE / Medical Power Supply, Efficiency Level: VI, Case Color/Style: GlobTek Black, Wall Plug-in+Desktop Combination, Regulated Switchmode AC-DC Power Supply AC Adaptor, Input Rating: 100-240V~, 50-60 Hz, IEC 60320/C6 w/ Wall Blades Option , Output Rating: 65W, 20V@3.25A, Output Configuration: 1200 mm, 16/2 Cond, Round Black, T-plug system (includes 5.5x2.5, 5.5x2.1, 3.5x1.3mm plugs in each kit), Ferrite: Core Size: RH 14.2*28.5*10, GlobTek Black, GT Cord # C19381, Pin Out: Polarity Configuration T00 All plugs are Medical Grade, Locking, Polarized once installed, and single use only. Product demonstration link: <a href="https://en.globtek.com/news/t00-changeable-output-plug-system-for-power-supplies">https://en.globtek.com/news/t00-changeable-output-plug-system-for-power-supplies</a> MOLDED CONNECTORS AVAILABLE, Blades/Input Cord: R-Series Desktop Insert, Approvals: ETL; Korea (20.1V-28V Only); CE; China RoHS; Class I; Level VI; RoHS; Ukraine; VCCI; WEEE; PSE; PSE; PSE; FCC; S-Mark IEC/EN 60601-1; EAC; ETL; CB 60601-1; IP42; CB 62368; cETLus 60601; cETLus;	
	Model No. GTM96600-6520-R3A	
	Part No./Ordering No. RR9LZ3250T00-IMR6B	Rev B

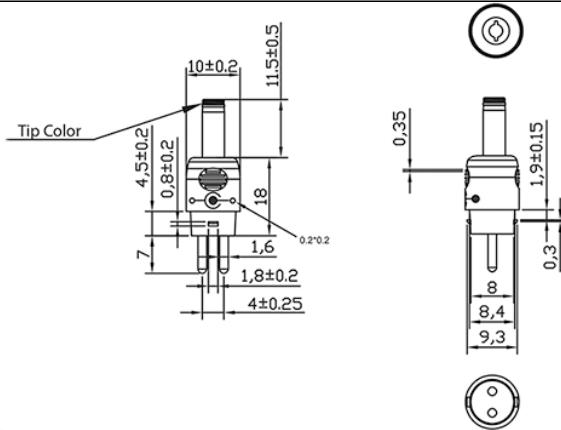

Part #	CROSS REFERENCE	OUTER DIAMETER	INNER DIAMETER	PINLENGTH	FORM FACTOR	MALE/FEMALE	INCLUDED IN T00 KIT	TIP COLOR	
T-K-11-S(R)	Philmore® 204/2049	3.5	1.3-	11	STRAIGHT	Female	x	Blue	
T-EJ2-95-S(R)	Philmore® 240 plug	4	1.7-	9.5	STRAIGHT	Female	Order Separately	Brown	
T-EJ3-95-S(R)	Philmore® 275 plug	4.75	1.7-	9.5	STRAIGHT	Female	Order Separately	Red	
T-C-95-S(R)	Switchcraft® 722A	5.5	2.1-	9.5	STRAIGHT	Female	Order Separately	Yellow	
T-C-12-S(R)	Switchcraft® 722A	5.5	2.1-	12	STRAIGHT	Female	x	Yellow	
T-L-95-S(R)	Switchcraft® 712A	5.5	2.5-	9.5	STRAIGHT	Female	Order Separately	Black	
T-L-12-S(R)	Switchcraft® 712A	5.5	2.5-	12	STRAIGHT	Female	x	Black	
T-EJ4-95-S(R)	Philmore® 255 plug	5.5	3.3	1	9.5	STRAIGHT	Female	Order Separately	Orange
T-EJ1-95-S(R)	Philmore 235 plug	2.35	0.7	9.5	STRAIGHT	Female	Order Separately	Yellow	
T-EJ5-115-S(R)	Philmore 265 plug	6.5	6	1	11.5	STRAIGHT	Female	Order Separately	Black

**STRAIGHT Female Barrels are available in length of 9mm-14mm**

ADDITIONAL OUTPUT PLUG OPTIONS ARE AVAILABLE AT <https://www.globtek.com/connectors/>

STANDARD PLUGS AND CONNECTORS CAN BE SEEN ONLINE AT <https://www.globtek.com/connectors/>

GlobTek, Inc. www.globtek.com 186 Veterans Drive, Northvale, NJ 07647 Tel. (201) 784-1000 Fax (201) 784-0111	Drawing Title: GTM96600-6520-R3A, ITE / Medical Power Supply, Efficiency Level: VI, Case Color/Style: GlobTek Black, Wall Plug-in+Desktop Combination, Regulated Switchmode AC-DC Power Supply AC Adaptor, Input Rating: 100-240V~, 50-60 Hz, IEC 60320/C6 w/ Wall Blades Option , Output Rating: 65W, 20V@3.25A, Output Configuration: 1200 mm, 16/2 Cond, Round Black, T-plug system (includes 5.5x2.5, 5.5x2.1, 3.5x1.3mm plugs in each kit), Ferrite: Core Size: RH 14.2*28.5*10, GlobTek Black, GT Cord # C19381, Pin Out: Polarity Configuration T00 All plugs are Medical Grade, Locking, Polarized once installed, and single use only. Product demonstration link: <a href="https://en.globtek.com/news/t00-changeable-output-plug-system-for-power-supplies">https://en.globtek.com/news/t00-changeable-output-plug-system-for-power-supplies</a> MOLDED CONNECTORS AVAILABLE, Blades/Input Cord: R-Series Desktop Insert, Approvals: ETL; Korea (20.1V-28V Only); CE; China RoHS; Class I; Level VI; RoHS; Ukraine; VCCI; WEEE; PSE; PSE; PSE; FCC; S-Mark IEC/EN 60601-1; EAC; ETL; CB 60601-1; IP42; CB 62368; cETLus 60601; cETLus;	
	Model No. GTM96600-6520-R3A	
	Part No./Ordering No. RR9LZ3250T00-IMR6B	Rev B

LABEL:L-1186

LABEL P/N: Standard GT

MATERIAL: Flat Thermal Transfer, Imprintable, Polyester Label and/or Pad Printed and/or Molded, and/or Laser Engraved in the case

BACKGROUND COLOR: Black if housing is Black, White or Silver if housing is White or Gray.

TEXT COLOR: White or Silver if label is Black Background for Black housing. Black if label is White or Silver background and Housing is White or Gray

LABEL WIDTH (mm): 44.5

LABEL HEIGHT (mm): 49.5

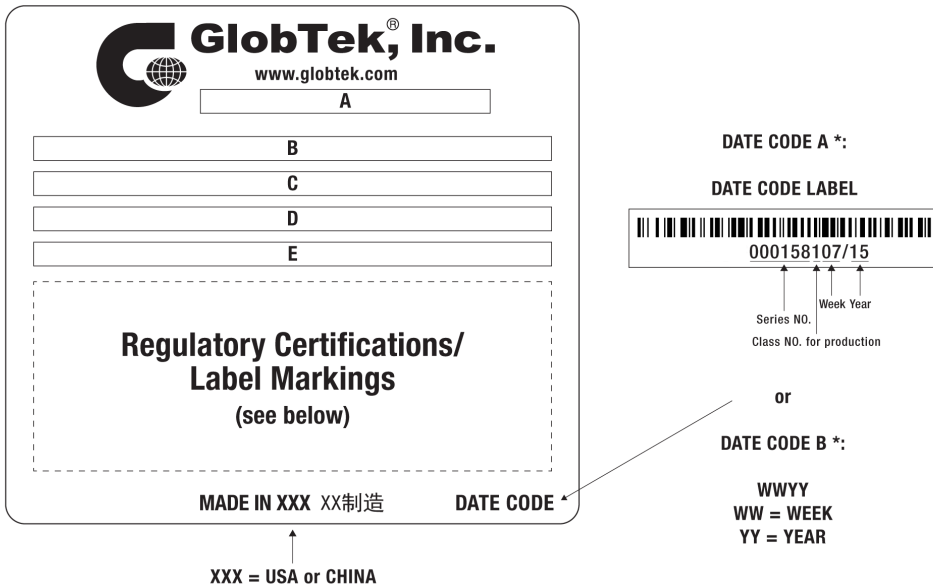

SPECIAL BARCODE LABEL MATERIAL:

Below is the minimum information which will appear on the label. NOTE: in the logo area additional/actual positioning of symbols and text is subjected to change as per agency updates/requirements or additional model approvals become available. Regulatory certifications/label markings may be in logo area on the label or molded into the case housing outside the label area. Information will be shown via label and/or pad printed and/or molded and/or laser engraved in the case. \* Date code markings at GlobTek option.



A=ITE / Medical Power Supply  
B=P/N: (料号) RR9LZ3250T00-IMR6B  
C=Model (型号) GTM96600-6520-R3A  
D=Input (输入) 100-240V~, 50-60 Hz, 1.5 A  
E=Output (输出) 20 V  $\equiv$  3.25 A, 65.0W

<p>GlobTek, Inc. www.globtek.com 186 Veterans Drive, Northvale, NJ 07647 Tel. (201) 784-1000 Fax (201) 784-0111</p>	<p>Drawing Title: GTM96600-6520-R3A, ITE / Medical Power Supply, Efficiency Level: VI, Case Color/Style: GlobTek Black, Wall Plug-in+Desktop Combination, Regulated Switchmode AC-DC Power Supply AC Adaptor, Input Rating: 100-240V~, 50-60 Hz, IEC 60320/C6 w/ Wall Blades Option , Output Rating: 65W, 20V@3.25A, Output Configuration: 1200 mm, 16/2 Cond, Round Black, T-plug system (includes 5.5x2.5, 5.5x2.1, 3.5x1.3mm plugs in each kit), Ferrite: Core Size: RH 14.2*28.5*10, GlobTek Black, GT Cord # C19381, Pin Out: Polarity Configuration T00 All plugs are Medical Grade, Locking, Polarized once installed, and single use only. Product demonstration link: <a href="https://en.globtek.com/news/t00-changeable-output-plug-system-for-power-supplies">https://en.globtek.com/news/t00-changeable-output-plug-system-for-power-supplies</a> MOLDED CONNECTORS AVAILABLE, Blades/Input Cord: R-Series Desktop Insert, Approvals: ETL; Korea (20.1V-28V Only); CE; China RoHS; Class I; Level VI; RoHS; Ukraine; VCCI; WEEE; PSE; PSE; PSE; FCC; S-Mark IEC/EN 60601-1; EAC; ETL; CB 60601-1; IP42; CB 62368; cETLus 60601; cETLus;</p>	
	<p>Model No. GTM96600-6520-R3A</p>	
	<p>Part No./Ordering No. RR9LZ3250T00-IMR6B</p>	<p>Rev B</p>

<p>AGENCY ONLINE DOCUMENTS <a href="http://www.globtek.info/certs/GTM96600-TZ/">http://www.globtek.info/certs/GTM96600-TZ/</a></p> <p>CE EC-Declaration for Medical <a href="http://globtek.force.com/models/ec_declaration?id=a0Oa000000FifXZEAZ">http://globtek.force.com/models/ec_declaration?id=a0Oa000000FifXZEAZ</a></p> <p>CE EC-Declaration for Industrial/Commercial/ITE <a href="http://globtek.force.com/models/ec_declaration?id=a0Oa000000FifXZEAZ">http://globtek.force.com/models/ec_declaration?id=a0Oa000000FifXZEAZ</a></p> <p>CE EC-Declaration for Household <a href="#">Contact GlobTek for more information</a></p> <p>RoHS/RoHS3 Declaration <a href="https://www.globtek.com/pdf/rohs_cert/01t0c000008P4XxAAK">https://www.globtek.com/pdf/rohs_cert/01t0c000008P4XxAAK</a></p> <p>REACH Declaration <a href="https://www.globtek.com/pdf/iso_certificates/REACH.pdf">https://www.globtek.com/pdf/iso_certificates/REACH.pdf</a></p> <p>Conflict Minerals Declaration <a href="https://www.globtek.com/pdf/conflict-minerals.pdf">https://www.globtek.com/pdf/conflict-minerals.pdf</a></p> <p>IPXY rating is based on 3rd party testing and customers should check suitability and test system level IPXY rating before ordering.</p> <p><b>Regulatory Certifications/Label Markings</b></p> <p>LATEST PRODUCT/MODEL CERTIFICATIONS: <a href="http://en.globtek.com/datasheet/id/a0Oa000000FifXZ">http://en.globtek.com/datasheet/id/a0Oa000000FifXZ</a></p> <p>AGENCY ONLINE DOCUMENTS: <a href="http://www.globtek.info/certs/GTM96600-TZ/">http://www.globtek.info/certs/GTM96600-TZ/</a></p> <p> (F2) Isolated Functional Earth for GTM96 series, Improved EMC</p> <p> Polarity Configuration T00 All plugs are Medical Grade, Locking, Polarized once installed, and single use only. Product demonstration link: <a href="https://en.globtek.com/news/t00-changeable-output-plug-system-for-power-supplies">https://en.globtek.com/news/t00-changeable-output-plug-system-for-power-supplies</a> MOLDED CONNECTORS AVAILABLE</p>
---

GloTek, Inc. www.globtek.com 186 Veterans Drive, Northvale, NJ 07647 Tel. (201) 784-1000 Fax (201) 784-0111	Drawing Title: GTM96600-6520-R3A, ITE / Medical Power Supply, Efficiency Level: VI, Case Color/Style: GlobTek Black, Wall Plug-in+Desktop Combination, Regulated Switchmode AC-DC Power Supply AC Adaptor, Input Rating: 100-240V~, 50-60 Hz, IEC 60320/C6 w/ Wall Blades Option , Output Rating: 65W, 20V@3.25A, Output Configuration: 1200 mm, 16/2 Cond, Round Black, T-plug system (includes 5.5x2.5, 5.5x2.1, 3.5x1.3mm plugs in each kit), Ferrite: Core Size: RH 14.2*28.5*10, GlobTek Black, GT Cord # C19381, Pin Out: Polarity Configuration T00 All plugs are Medical Grade, Locking, Polarized once installed, and single use only. Product demonstration link: <a href="https://en.globtek.com/news/t00-changeable-output-plug-system-for-power-supplies">https://en.globtek.com/news/t00-changeable-output-plug-system-for-power-supplies</a> MOLDED CONNECTORS AVAILABLE, Blades/Input Cord: R-Series Desktop Insert, Approvals: ETL; Korea (20.1V-28V Only); CE; China RoHS; Class I; Level VI; RoHS; Ukraine; VCCI; WEEE; PSE; PSE; PSE; FCC; S-Mark IEC/EN 60601-1; EAC; ETL; CB 60601-1; IP42; CB 62368; cETLus 60601; cETLus;	
	Model No. GTM96600-6520-R3A	
	Part No./Ordering No. RR9LZ3250T00-IMR6B	Rev B

## PACKAGING

Packing Spec P/N:	Packing for DT (hybrid) model with T00 plug and manual
Box Qty:	30
Gift Box Size (mm):	142*115*60
Gift Box Color:	White
Master Carton Size (mm):	442 x 330 x 275
Master Carton Cubic Volume (m <sup>3</sup> ):	0.04
Master GW (Kg):	15.2 kg
BLADES INCLUDED:	R-DI:
BLADE/CORD INSTALLED:	R-DI:
USER MANUAL:	809-PSURKITUSERMANUAL on A4 paper
USER MANUAL WEB LINK:	<a href="https://www.globtek.com/pdf/809-PSURKITUSERMANU...">https://www.globtek.com/pdf/809-PSURKITUSERMANU...</a>

### PROPRIETARY INFORMATION

GlobTek, Inc.  
 www.globtek.com  
 186 Veterans Drive,  
 Northvale, NJ 07647  
 Tel. (201) 784-1000  
 Fax (201) 784-0111

Drawing Title: GTM96600-6520-R3A, ITE / Medical Power Supply, Efficiency Level: VI, Case Color/Style: GlobTek Black, Wall Plug-in+Desktop Combination, Regulated Switchmode AC-DC Power Supply AC Adaptor, Input Rating: 100-240V~, 50-60 Hz, IEC 60320/C6 w/ Wall Blades Option , Output Rating: 65W, 20V@3.25A, Output Configuration: 1200 mm, 16/2 Cond, Round Black, T-plug system (includes 5.5x2.5, 5.5x2.1, 3.5x1.3mm plugs in each kit), Ferrite: Core Size: RH 14.2\*28.5\*10, GlobTek Black, GT Cord # C19381, Pin Out: Polarity Configuration T00 All plugs are Medical Grade, Locking, Polarized once installed, and single use only. Product demonstration link: <https://en.globtek.com/news/t00-changeable-output-plug-system-for-power-supplies> MOLDED CONNECTORS AVAILABLE, Blades/Input Cord: R-Series Desktop Insert, Approvals: ETL; Korea (20.1V-28V Only); CE; China RoHS; Class I; Level VI; RoHS; Ukraine; VCCI; WEEE; PSE; PSE; PSE; FCC; S-Mark IEC/EN 60601-1; EAC; ETL; CB 60601-1; IP42; CB 62368; cETLus 60601; cETLus;

Model No. GTM96600-6520-R3A

Part No./Ordering No. RR9LZ3250T00-IMR6B

Rev B

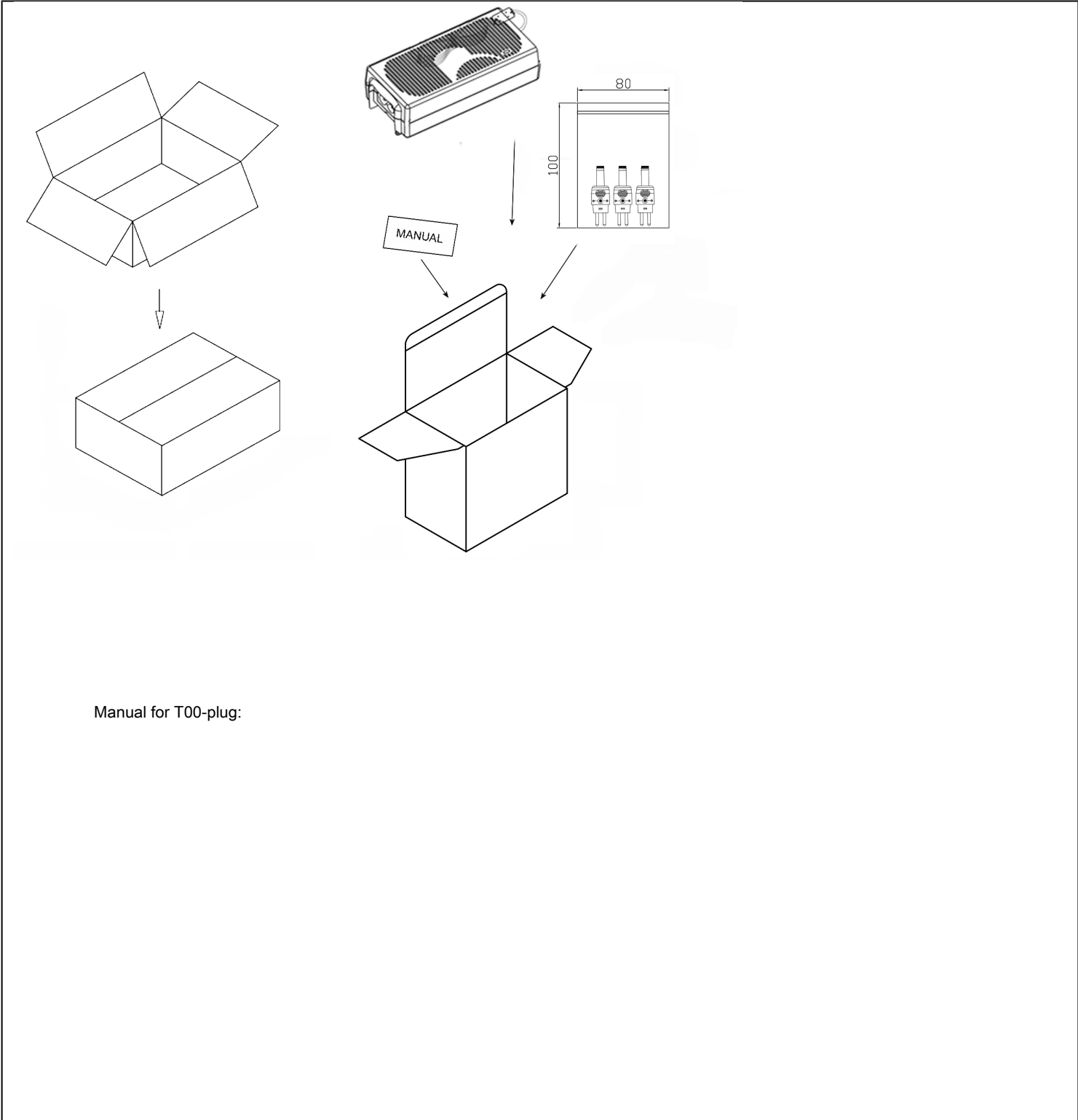

Manual for T00-plug:

GlobTek, Inc. www.globtek.com 186 Veterans Drive, Northvale, NJ 07647 Tel. (201) 784-1000 Fax (201) 784-0111	Drawing Title: GTM96600-6520-R3A, ITE / Medical Power Supply, Efficiency Level: VI, Case Color/Style: GlobTek Black, Wall Plug-in+Desktop Combination, Regulated Switchmode AC-DC Power Supply AC Adaptor, Input Rating: 100-240V~, 50-60 Hz, IEC 60320/C6 w/ Wall Blades Option , Output Rating: 65W, 20V@3.25A, Output Configuration: 1200 mm, 16/2 Cond, Round Black, T-plug system (includes 5.5x2.5, 5.5x2.1, 3.5x1.3mm plugs in each kit), Ferrite: Core Size: RH 14.2*28.5*10, GlobTek Black, GT Cord # C19381, Pin Out: Polarity Configuration T00 All plugs are Medical Grade, Locking, Polarized once installed, and single use only. Product demonstration link: <a href="https://en.globtek.com/news/t00-changeable-output-plug-system-for-power-supplies">https://en.globtek.com/news/t00-changeable-output-plug-system-for-power-supplies</a> MOLDED CONNECTORS AVAILABLE, Blades/Input Cord: R-Series Desktop Insert, Approvals: ETL; Korea (20.1V-28V Only); CE; China RoHS; Class I; Level VI; RoHS; Ukraine; VCCI; WEEE; PSE; PSE; PSE; FCC; S-Mark IEC/EN 60601-1; EAC; ETL; CB 60601-1; IP42; CB 62368; cETLus 60601; cETLus;	
	Model No. GTM96600-6520-R3A	
	Part No./Ordering No. RR9LZ3250T00-IMR6B	Rev B



**T-Tip Instructions**

- Color of tip indicates dimensions of barrel
- Polarity is dependent on how tip is inserted in to T-base

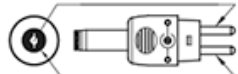

This Pin Connects to Center



This Pin Connects to Barrel

PART NO	DIAMETER		LENGTH	TIP COLOR
	OUTER	INNER		
T-C-12-S(R)	5.5	2.1	12	YELLOW
T-L-12-S(R)	5.5	2.5	12	BLACK
T-K-11-S(R)	3.5	1.3	11	BLUE
T-EJ2-95-S(R)	4.0	1.7	9.5	BROWN
T-EJ3-95-S(R)	4.75	1.7	9.5	RED
T-EJ4-95-S(R)	5.5	3.3	9.5	ORANGE
T-EJ1-95-S(R)	2.35	0.7	9.5	YELLOW
T-EJ5-115-S(R)	6.5	6.0	11.5	BLACK

On the back blank side add:

**Molded options available upon request**



GlobTek, Inc. www.globtek.com 186 Veterans Drive, Northvale, NJ 07647 Tel. (201) 784-1000 Fax (201) 784-0111	Drawing Title: GTM96600-6520-R3A, ITE / Medical Power Supply, Efficiency Level: VI, Case Color/Style: GlobTek Black, Wall Plug-in+Desktop Combination, Regulated Switchmode AC-DC Power Supply AC Adaptor, Input Rating: 100-240V~, 50-60 Hz, IEC 60320/C6 w/ Wall Blades Option , Output Rating: 65W, 20V@3.25A, Output Configuration: 1200 mm, 16/2 Cond, Round Black, T-plug system (includes 5.5x2.5, 5.5x2.1, 3.5x1.3mm plugs in each kit), Ferrite: Core Size: RH 14.2*28.5*10, GlobTek Black, GT Cord # C19381, Pin Out: Polarity Configuration T00 All plugs are Medical Grade, Locking, Polarized once installed, and single use only. Product demonstration link: <a href="https://en.globtek.com/news/t00-changeable-output-plug-system-for-power-supplies">https://en.globtek.com/news/t00-changeable-output-plug-system-for-power-supplies</a> MOLDED CONNECTORS AVAILABLE, Blades/Input Cord: R-Series Desktop Insert, Approvals: ETL; Korea (20.1V-28V Only); CE; China RoHS; Class I; Level VI; RoHS; Ukraine; VCCI; WEEE; PSE; PSE; PSE; FCC; S-Mark IEC/EN 60601-1; EAC; ETL; CB 60601-1; IP42; CB 62368; cETLus 60601; cETLus;	
	Model No. GTM96600-6520-R3A	
	Part No./Ordering No. RR9LZ3250T00-IMR6B	Rev B

## INSTRUCTIONS TO THE OEM SYSTEMS ENGINEER

It is the responsibility of the OEM systems engineer to provide the end system user instructions and warnings for the use of this product in the end system.

If an input cord is required for this product, AC Mains voltage should be provided to the power supply by a power supply cord approved to the national standards of the country in which it will be used.

This power supply is not designed to be repaired. No serviceable parts inside. A blown internal fuse is an indication of catastrophic failure of circuit component(s). If a Failure Analysis is required for a failed power supply/battery charger, please return the damaged unit to Globtek for an accurate determination of the root cause of the failure.

EMC Compliance of the complete OEM product, including the GlobTek power supply/battery charger needs to be verified by the OEM systems engineer.

## INSTRUCTION SHEET

N/A

### PROPRIETARY INFORMATION