

|   |  |
|---|--|
| <p>GlobTek, Inc.<br/>www.globtek.com<br/>186 Veterans Drive,<br/>Northvale, NJ 07647<br/>Tel. (201) 784-1000<br/>Fax (201) 784-0111</p> | <p>Drawing Title: GT-86121-1209-W2, ICT/ITE Power Supply, Efficiency Level: USA DOE Level VI / Eco-design Directive 2009/125/EC, (EU) 2019/1782, Case Color/Style: GlobTek Black, Wall Plug-in, Regulated Switchmode AC-DC Power Supply AC Adaptor, Input Rating: 100-240V- , 50/60Hz, N. America NEMA 1-15 Fixed , Output Rating: 12W, 9.0V@1.33A, Output Configuration: 1500 mm, 22/2 Cond, UL 2468, Female Barrel 5.5 * 2.5 * 11mm with internal Spring Clip and Locking Notch or Equal, Ferrite: None, GlobTek Black, GT Cord # C3134, Pin Out: Center Positive (+V), Blades/Input Cord: Fixed Blades North American 1-15P, Approvals: CB 62368; China RoHS; Double Insulation; PSE; PSE; Level VI; RoHS; Ukraine; VCCI; WEEE; cULus; EAC; LPS 62368; LPS 60950;</p> |
| <p>Model No. GT-86121-1209-W2</p>   |  |
| <p>Part No./Ordering No. WR9HD1330LCP-F(R6B)</p>  | <p>Rev A</p>   |

## REVISION HISTORY

| REV | DESCRIPTION     | SUB | DATE       | APPROVED |
|-----|-----------------|-----|------------|----------|
| A   | INITIAL RELEASE |     | 12/07/2018 | QA       |

In Addition to GlobTek Inc.'s renewed ISO9001:2015 - Quality Management System Certification, GlobTek Inc. is now certified to:

ISO13485:2016 - Medical Devices Quality Management System Certification

ISO14001:2015 - Environmental Management System Certification

ISO Certificates are available online at <https://www.globtek.com/iso-certificates/>

### Customer Approval of Specification:

Please approve, sign and send back to GlobTek so we can complete order processing.

A delay in receipt of this form will delay delivery schedule.

Company Name:

Customer P/N:

Quote Number:

Date:

Authorized Representative Name:

Authorized Representative Signature:

The acceptance of this specification and use of the product described in this document indicates the acceptance and binding of the customer to Globtek terms and conditions, which supersede all other agreements, terms, and conditions (<https://en.globtek.com/terms-and-conditions/>).

The purchaser of this product (Customer) agrees that it is their sole responsibility to determine suitability/fitness of the product described in this specification for their application and to take precautions for protection against any hazards attendant to the handling and use of the product.

### Footnote:

GlobTek Inc. will not be liable for the safety and performance of these power supplies if unauthorized access and repair occurs. End user should consult applicable UL, CSA or EN standards for proper installation instruction.

### Limitation of Use:

GlobTek products are intended for use with commercial, medical, and/or industrial equipment only. GlobTek product are not authorized for use as mission critical components in life support hazardous environment, nuclear or aircraft applications without prior written approval from the CEO of GlobTek Inc. Contents of this document are subject to change without prior notice.

|   |   |
|---|---|
| <b>GlobTek, Inc.</b><br><b>www.globtek.com</b><br><b>186 Veterans Drive,</b><br><b>Northvale, NJ 07647</b><br><b>Tel. (201) 784-1000</b><br><b>Fax (201) 784-0111</b> | Drawing Title: GT-86121-1209-W2, ICT/ITE Power Supply, Efficiency Level: USA DOE Level VI / Eco-design Directive 2009/125/EC, (EU) 2019/1782, Case Color/Style: GlobTek Black, Wall Plug-in, Regulated Switchmode AC-DC Power Supply AC Adaptor, Input Rating: 100-240V- , 50/60Hz, N. America NEMA 1-15 Fixed , Output Rating: 12W, 9.0V@1.33A, Output Configuration: 1500 mm, 22/2 Cond, UL 2468, Female Barrel 5.5 * 2.5 * 11mm with internal Spring Clip and Locking Notch or Equal, Ferrite: None, GlobTek Black, GT Cord # C3134, Pin Out: Center Positive (+V), Blades/Input Cord: Fixed Blades North American 1-15P, Approvals: CB 62368; China RoHS; Double Insulation; PSE; PSE; Level VI; RoHS; Ukraine; VCCI; WEEE; cULus; EAC; LPS 62368; LPS 60950; |
|   | Model No. GT-86121-1209-W2<br>Part No./Ordering No. WR9HD1330LCP-F(R6B)   |

Rev A

**POWER SUPPLY INFORMATION**

|                                 |   |
|---------------------------------|---|
| TYPE:                           | Wall Plug-in  |
| TECHNOLOGY:                     | Regulated Switchmode AC-DC Power Supply AC Adaptor  |
| CASE COLOR:                     | GlobTek Black   |
| NAMEPLATE RATED INPUT:          | 100-240V- , 50/60Hz, 0.5A   |
| INPUT CONFIG:                   | N. America NEMA 1-15 Fixed  |
| WATTS:                          | 12.0  |
| VOLTS OUT:                      | 9.0   |
| CURRENT OUT (Amps):             | 1.33  |
| BLADE/CORD INCLUDED:            | FBNA2 Fixed Blades North American 1-15P   |
| BLADE/CORD INSTALLED:           | FBNA2 :Fixed Blades North American 1-15P  |
| INGRESS PROTECTION:             | IPX0  |
| GROUNDING CONFIGURATION:        | (F1) Class II / Double Insulated  |
| EFFICIENCY LEVEL:               | USA DOE Level VI / Eco-design Directive 2009/125/EC, (EU) 2019/1782   |
| OUTPUT CONFIGURATION:           | 1500 mm, 22/2 Cond, UL 2468, Female Barrel 5.5 * 2.5 * 11mm with internal Spring Clip and Locking Notch or Equal, Ferrite: None, GlobTek Black, GT Cord # C3134 |
| OVERMOLDED:                     | Yes   |
| CONNECTOR PIN OUT:              | Center Positive (+V)  |
| LABEL SPECS:                    | Standard GT,L-1186  |
| SPECIAL BARCODE LABEL MATERIAL: | No  |
| PACK SPEC:                      | Standard WPI, Individually Box, User manual DT  |
| USER MANUAL:                    | 809-DESKTOPUSERMANUAL on A4 paper   |

**PROPRIETARY INFORMATION**

PROPRIETARY OF GLOBTEK, INC. ANY REPRODUCTION, DISCLOSURE OR USE OF THIS DRAWING, IN WHOLE OR IN PART, IS HEREBY PROHIBITED EXCEPT AS SPECIFIED IN

WRITING BY GLOBTEK, INC. © GlobTek, Inc. 2018 - 2021

quest /06/13/2021 10:48:30 PM CLONED FROM WR9HD1000LCP-F(R6B)

|  |  |              |
|--|--|--------------|
| <p>GlobTek, Inc.<br/> www.globtek.com<br/> 186 Veterans Drive,<br/> Northvale, NJ 07647<br/> Tel. (201) 784-1000<br/> Fax (201) 784-0111</p> | <p>Drawing Title: GT-86121-1209-W2, ICT/ITE Power Supply, Efficiency Level: USA DOE Level VI / Eco-design Directive 2009/125/EC, (EU) 2019/1782, Case Color/Style: GlobTek Black, Wall Plug-in, Regulated Switchmode AC-DC Power Supply AC Adaptor, Input Rating: 100-240V- , 50/60Hz, N. America NEMA 1-15 Fixed , Output Rating: 12W, 9.0V@1.33A, Output Configuration: 1500 mm, 22/2 Cond, UL 2468, Female Barrel 5.5 * 2.5 * 11mm with internal Spring Clip and Locking Notch or Equal, Ferrite: None, GlobTek Black, GT Cord # C3134, Pin Out: Center Positive (+V), Blades/Input Cord: Fixed Blades North American 1-15P, Approvals: CB 62368; China RoHS; Double Insulation; PSE; PSE; Level VI; RoHS; Ukraine; VCCI; WEEE; cULus; EAC; LPS 62368; LPS 60950;</p> |              |
|  | <p>Model No. GT-86121-1209-W2</p>  |              |
|  | <p>Part No./Ordering No. WR9HD1330LCP-F(R6B)</p>   | <p>Rev A</p> |

Notes/Modifications/Customizations (notes in this section supersede the values shown in the standard spec):  
DIMENSIONS ARE IN MM UNLESS SPECIFIED OTHERWISE.

|   |   |              |
|---|---|--------------|
| <p>GlobTek, Inc.<br/>www.globtek.com<br/>186 Veterans Drive,<br/>Northvale, NJ 07647<br/>Tel. (201) 784-1000<br/>Fax (201) 784-0111</p> | <p>Drawing Title: GT-86121-1209-W2, ICT/ITE Power Supply, Efficiency Level: USA DOE Level VI / Eco-design Directive 2009/125/EC, (EU) 2019/1782, Case Color/Style: GlobTek Black, Wall Plug-in, Regulated Switchmode AC-DC Power Supply AC Adaptor, Input Rating: 100-240V- , 50/60Hz, N. America NEMA 1-15 Fixed , Output Rating: 12W, 9.0V@1.33A, Output Configuration: 1500 mm, 22/2 Cond, UL 2468, Female Barrel 5.5 * 2.5 * 11mm with internal Spring Clip and Locking Notch or Equal, Ferrite: None, GlobTek Black, GT Cord # C3134, Pin Out: Center Positive (+V), Blades/Input Cord: Fixed Blades North American 1-15P, Approvals: CB 62368; China RoHS; Double Insulation; PSE; PSE; Level VI; RoHS; Ukraine; VCCI; WEEE; cULus; EAC; LPS 62368; LPS 60950;</p> <p>Model No. GT-86121-1209-W2</p> <p>Part No./Ordering No. WR9HD1330LCP-F(R6B)</p> | <p>Rev A</p> |
|---|---|--------------|

## ELECTRICAL SPECIFICATIONS

### ELECTRICAL SPECIFICATIONS:

01. Input Voltage: Specified 90-264 Vac, Nameplate rated: 100-240Vac
02. Input Frequency: Specified 47-63 Hz, Nameplate rated 50-60Hz
03. Output Regulation: +/- 5%
04. Ripple and Noise (Vp-p): 200 mVp-p maximum, At 20 MHz, and output parallel with 0.1uF & 47uF capacitors to ground. Temperature at 25 °C, and nominal input voltage
05. Efficiency: Compliant with Efficiency Level VI and ErP European Commission's Ecodesign Directive (2005/32/EC) / CoC Tier 2 Compliant
06. No Load Standby Power: <0.075W @ 230Vac
07. Turn-ON Delay: 3 Seconds maximum at nominal input voltage
08. Rise Time: 100mS maximum at nominal input voltage

### B) PROTECTION

01. Over-Voltage
02. Over current protection with auto-recovery function
03. Short Circuit: Short circuit protection is to be included in the construction of the adaptor. The adaptor is designed to withstand continuous current of a short circuit on the output. The adaptor will be short circuit tolerant for an indefinite period.

### C) SAFETY

01. Dielectric Withstand Voltage: 3000VAC 10mA 1minute or 4242VDC 10mA 1minute from primary to secondary
02. Leakage current: 0.25mA maximum, at nominal AC input voltage and frequency

### D) EMC

01. Emissions, per EN 55032, EN 61000-6-3, EN 61000-6-4
  - Conducted Emissions: Class B, FCC Part 15, Class B
  - Radiated Emissions: Class B, FCC Part 15, Class B
02. Line Frequency Harmonics EN61000-3-2, Class A
03. Voltage Fluctuations/Flicker EN61000-3-3
04. Immunity, per EN 55024, EN 61000-6-1, EN 61000-6-2
  - Static Discharge Immunity EN61000-4-2, 4kV Contact Discharge, 8kV air discharge
  - Radiated RF Immunity EN61000-4-3, 3V/m 80-1000MHz, 80% 1KHz AM.
  - EFT/Burst Immunity EN61000-4-4, 1kV/100kHz.
  - Line Surge Immunity EN61000-4-5, 1kV differential, 2kV common-mode
  - Conducted RF Immunity EN61000-4-6, 3Vrms, 80% 1KHz AM
  - Power Frequency Magnetic Field Immunity EN61000-4-8, 1A/m
  - Voltage Dip Immunity EN61000-4-11, Criteria

### E) OTHER:

01. MTBF: 200,000 Hours @ 25°C ambient temperature
02. Operating Temperature: 0°C to 50°C ambient temperature (RFP7139)
03. Humidity: 5% to 90% relative humidity
04. Storage Temperature: -20°C to 60°C
05. Cooling: natural convection cooling
06. ROHS 2: Complies with EU 2011/65/EU and China SJ/T 11363-2006

### F) ENCLOSURE

01. Housing: High impact plastic, 94V0 polycarbonate, non-vented
02. Markings: Label and/or Pad Printed and/or Molded in the case

## PROPRIETARY INFORMATION

PROPRIETARY OF GLOBTEK, INC. ANY REPRODUCTION, DISCLOSURE OR USE OF THIS DRAWING, IN WHOLE OR IN PART, IS HEREBY PROHIBITED EXCEPT AS SPECIFIED IN

WRITING BY GLOBTEK, INC. © GlobTek, Inc. 2018 - 2021

quest/06/13/2021 10:48:30 PM CLONED FROM WR9HD1000LCP-F(R6B)

|  |  |              |
|--|--|--------------|
| <p>GlobTek, Inc.<br/> www.globtek.com<br/> 186 Veterans Drive,<br/> Northvale, NJ 07647<br/> Tel. (201) 784-1000<br/> Fax (201) 784-0111</p> | <p>Drawing Title: GT-86121-1209-W2, ICT/ITE Power Supply, Efficiency Level: USA DOE Level VI / Eco-design Directive 2009/125/EC, (EU) 2019/1782, Case Color/Style: GlobTek Black, Wall Plug-in, Regulated Switchmode AC-DC Power Supply AC Adaptor, Input Rating: 100-240V- , 50/60Hz, N. America NEMA 1-15 Fixed , Output Rating: 12W, 9.0V@1.33A, Output Configuration: 1500 mm, 22/2 Cond, UL 2468, Female Barrel 5.5 * 2.5 * 11mm with internal Spring Clip and Locking Notch or Equal, Ferrite: None, GlobTek Black, GT Cord # C3134, Pin Out: Center Positive (+V), Blades/Input Cord: Fixed Blades North American 1-15P, Approvals: CB 62368; China RoHS; Double Insulation; PSE; PSE; Level VI; RoHS; Ukraine; VCCI; WEEE; cULus; EAC; LPS 62368; LPS 60950;</p> |              |
|  | <p>Model No. GT-86121-1209-W2</p>  |              |
|  | <p>Part No./Ordering No. WR9HD1330LCP-F(R6B)</p>   | <p>Rev A</p> |

TO ADDRESS SYSTEM-LEVEL EMI CONCERNS, FERRITE CHOKES/BEADS MAY BE ADDED/REVISED UPON REQUEST. A SAMPLE KIT OF GLOBTEK'S STANDARD FERRITES IS AVAILABLE UNDER GLOBTEK P/N: EMI-MITIGATION-KIT1

FOR ADDITIONAL INFORMATION, PLEASE READ OUR WHITE PAPER AT:

<https://en.globtek.com/technical-articles/ferrite-kit-radiated-emi-suppression-kit-for-globtek-power-supplies-cable-assemblies>

INGRESS PROTECTION: IPX0

|  |  |              |
|--|--|--------------|
| <p>GlobTek, Inc.<br/> www.globtek.com<br/> 186 Veterans Drive,<br/> Northvale, NJ 07647<br/> Tel. (201) 784-1000<br/> Fax (201) 784-0111</p> | <p>Drawing Title: GT-86121-1209-W2, ICT/ITE Power Supply, Efficiency Level: USA DOE Level VI / Eco-design Directive 2009/125/EC, (EU) 2019/1782, Case Color/Style: GlobTek Black, Wall Plug-in, Regulated Switchmode AC-DC Power Supply AC Adaptor, Input Rating: 100-240V- , 50/60Hz, N. America NEMA 1-15 Fixed , Output Rating: 12W, 9.0V@1.33A, Output Configuration: 1500 mm, 22/2 Cond, UL 2468, Female Barrel 5.5 * 2.5 * 11mm with internal Spring Clip and Locking Notch or Equal, Ferrite: None, GlobTek Black, GT Cord # C3134, Pin Out: Center Positive (+V), Blades/Input Cord: Fixed Blades North American 1-15P, Approvals: CB 62368; China RoHS; Double Insulation; PSE; PSE; Level VI; RoHS; Ukraine; VCCI; WEEE; cULus; EAC; LPS 62368; LPS 60950;</p> |              |
|  | <p>Model No. GT-86121-1209-W2</p>  |              |
|  | <p>Part No./Ordering No. WR9HD1330LCP-F(R6B)</p>   | <p>Rev A</p> |

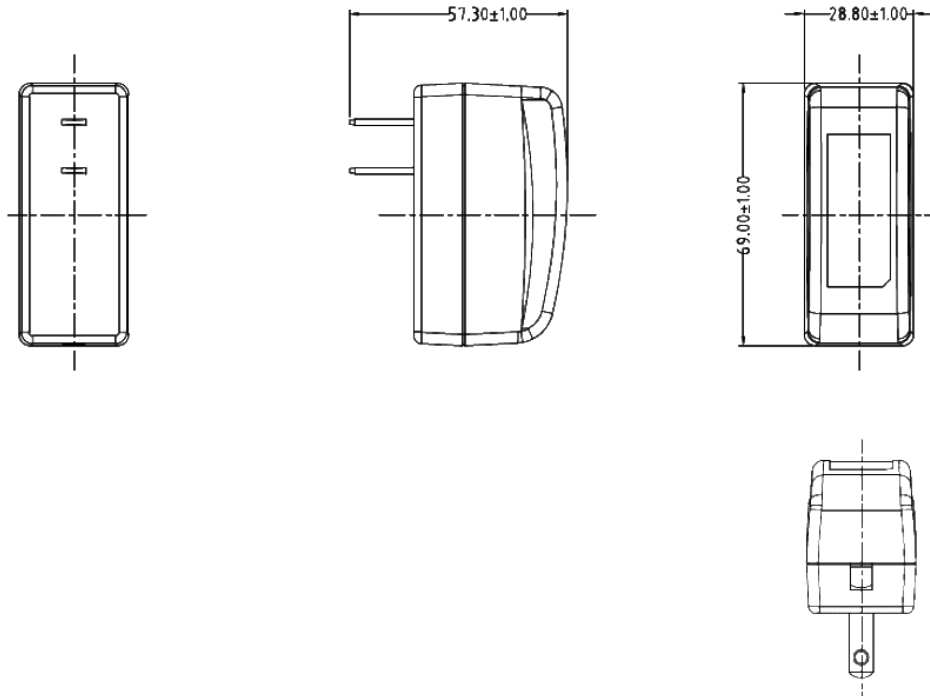

|  |   |              |
|--|---|--------------|
| <p>GlobTek, Inc.<br/> www.globtek.com<br/> 186 Veterans Drive,<br/> Northvale, NJ 07647<br/> Tel. (201) 784-1000<br/> Fax (201) 784-0111</p> | <p>Drawing Title: GT-86121-1209-W2, ICT/ITE Power Supply, Efficiency Level: USA DOE Level VI / Eco-design Directive 2009/125/EC, (EU) 2019/1782, Case Color/Style: GlobTek Black, Wall Plug-in, Regulated Switchmode AC-DC Power Supply AC Adaptor, Input Rating: 100-240V- , 50/60Hz, N. America NEMA 1-15 Fixed , Output Rating: 12W, 9.0V@1.33A, Output Configuration: 1500 mm, 22/2 Cond, UL 2468, Female Barrel 5.5 * 2.5 * 11mm with internal Spring Clip and Locking Notch or Equal, Ferrite: None, GlobTek Black, GT Cord # C3134, Pin Out: Center Positive (+V), Blades/Input Cord: Fixed Blades North American 1-15P, Approvals: CB 62368; China RoHS; Double Insulation; PSE; PSE; Level VI; RoHS; Ukraine; VCCI; WEEE; cULus; EAC; LPS 62368; LPS 60950;</p> <p>Model No. GT-86121-1209-W2</p> <p>Part No./Ordering No. WR9HD1330LCP-F(R6B)</p> | <p>Rev A</p> |
|--|---|--------------|

DERATING CURVE

**Typical External Power Supply Derating Curve**  
(For Efficiency Level V and Efficiency Level VI Products)

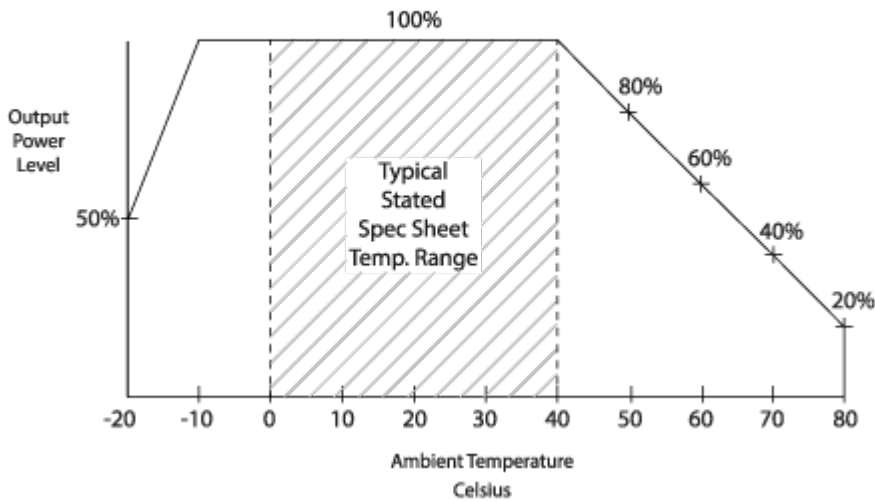

|  |  |   |
|--|--|---|
| <p>GlobTek, Inc.<br/> www.globtek.com<br/> 186 Veterans Drive,<br/> Northvale, NJ 07647<br/> Tel. (201) 784-1000<br/> Fax (201) 784-0111</p> | <p>Drawing Title: GT-86121-1209-W2, ICT/ITE Power Supply, Efficiency Level: USA DOE Level VI / Eco-design Directive 2009/125/EC, (EU) 2019/1782, Case Color/Style: GlobTek Black, Wall Plug-in, Regulated Switchmode AC-DC Power Supply AC Adaptor, Input Rating: 100-240V- , 50/60Hz, N. America NEMA 1-15 Fixed , Output Rating: 12W, 9.0V@1.33A, Output Configuration: 1500 mm, 22/2 Cond, UL 2468, Female Barrel 5.5 * 2.5 * 11mm with internal Spring Clip and Locking Notch or Equal, Ferrite: None, GlobTek Black, GT Cord # C3134, Pin Out: Center Positive (+V), Blades/Input Cord: Fixed Blades North American 1-15P, Approvals: CB 62368; China RoHS; Double Insulation; PSE; PSE; Level VI; RoHS; Ukraine; VCCI; WEEE; cULus; EAC; LPS 62368; LPS 60950;</p> | <p>Model No. GT-86121-1209-W2<br/> Part No./Ordering No. WR9HD1330LCP-F(R6B)<br/> Rev A</p> |
|--|--|---|

**INPUT CONFIGURATION**

(F1) Class II / Double Insulated



[Alternate grounding configurations](#) available upon request.

Blades/Cord Included:FBNA2:Fixed Blades North American 1-15P

Blades/Cord Installed:FBNA2:Fixed Blades North American 1-15P

NEMA 1-15P, North America Blades, Class II 2 Conductors

All NEMA 1 devices are two-wire non-grounding devices (hot-neutral) rated for 125 V maximum. NEMA 1-15P plugs have two parallel flat blades, 0.25 inches (6.35 mm) wide, 0.06 inches (1.524 mm) thick, 0.625-0.718 inches (15.875–18.256 mm) long, and spaced 0.5 inches (12.7 mm) apart.



|   |   |
|---|---|
| GlobTek, Inc.<br>www.globtek.com<br>186 Veterans Drive,<br>Northvale, NJ 07647<br>Tel. (201) 784-1000<br>Fax (201) 784-0111 | Drawing Title: GT-86121-1209-W2, ICT/ITE Power Supply, Efficiency Level: USA DOE Level VI / Eco-design Directive 2009/125/EC, (EU) 2019/1782, Case Color/Style: GlobTek Black, Wall Plug-in, Regulated Switchmode AC-DC Power Supply AC Adaptor, Input Rating: 100-240V- , 50/60Hz, N. America NEMA 1-15 Fixed , Output Rating: 12W, 9.0V@1.33A, Output Configuration: 1500 mm, 22/2 Cond, UL 2468, Female Barrel 5.5 * 2.5 * 11mm with internal Spring Clip and Locking Notch or Equal, Ferrite: None, GlobTek Black, GT Cord # C3134, Pin Out: Center Positive (+V), Blades/Input Cord: Fixed Blades North American 1-15P, Approvals: CB 62368; China RoHS; Double Insulation; PSE; PSE; Level VI; RoHS; Ukraine; VCCI; WEEE; cULus; EAC; LPS 62368; LPS 60950; |
|   | Model No. GT-86121-1209-W2  |
| Part No./Ordering No. WR9HD1330LCP-F(R6B)   | Rev A   |

**OUTPUT CORD AND CONNECTOR: LCL/C3134**

ACTUAL CONNECTORS, OVERMOLDS, FERRITES MAY VARY SLIGHTLY FROM THE PICTURE BELOW

|   |   |
|---|---|
| CABLE TYPE                                      | UL 2468   |
| CABLE LENGTH (mm)                               | 1500  |
| CABLE TOLERANCE (mm)                            | +150-0  |
| WIRE GAUGE (AWG)                                | 22  |
| CONDUCTORS                                      | 2   |
| HANK DIMENSION (mm)                             | 80 ± 10   |
| CABLE / CONNECTOR OVERMOLD COLOR                | GlobTek Black   |
| FERRITE TYPE / DIMENSION                        | None  |
| FERRITE # OF TURNS <a href="#">(Definition)</a> | N/A   |
| FERRITE DIMENSION FROM STRAIN RELIEF            | N/A   |
| FERRITE DIMENSION FROM PLUG                     | N/A   |
| PLUG TYPE                                       | Female Barrel 5.5 * 2.5 * 11mm with internal Spring Clip and Locking Notch or Equal |
| OUTPUT CONNECTOR GENDER                         |   |
| OVERMOLDED                                      | Yes   |
| OVER MOLD ORIENTATION                           | Straight  |
| CONNECTOR PIN OUT:                              | Center Positive (+V)  |
| ADDITIONAL REQUIREMENTS                         |   |

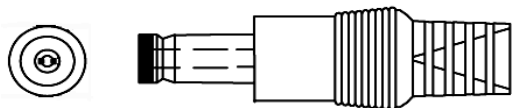

ADDITIONAL OUTPUT PLUG OPTIONS ARE AVAILABLE AT <https://www.globtek.com/connectors/>  
STANDARD PLUGS AND CONNECTORS CAN BE SEEN ONLINE AT <https://www.globtek.com/connectors/>  
CALCULATE VOLTAGE REGULATION/DROP WITH OUR ONLINE CALCULATOR: <https://en.globtek.com/output-cable-regulation-calculator/>

|  |  |              |
|--|--|--------------|
| <p>GlobTek, Inc.<br/> www.globtek.com<br/> 186 Veterans Drive,<br/> Northvale, NJ 07647<br/> Tel. (201) 784-1000<br/> Fax (201) 784-0111</p> | <p>Drawing Title: GT-86121-1209-W2, ICT/ITE Power Supply, Efficiency Level: USA DOE Level VI / Eco-design Directive 2009/125/EC, (EU) 2019/1782, Case Color/Style: GlobTek Black, Wall Plug-in, Regulated Switchmode AC-DC Power Supply AC Adaptor, Input Rating: 100-240V- , 50/60Hz, N. America NEMA 1-15 Fixed , Output Rating: 12W, 9.0V@1.33A, Output Configuration: 1500 mm, 22/2 Cond, UL 2468, Female Barrel 5.5 * 2.5 * 11mm with internal Spring Clip and Locking Notch or Equal, Ferrite: None, GlobTek Black, GT Cord # C3134, Pin Out: Center Positive (+V), Blades/Input Cord: Fixed Blades North American 1-15P, Approvals: CB 62368; China RoHS; Double Insulation; PSE; PSE; Level VI; RoHS; Ukraine; VCCI; WEEE; cULus; EAC; LPS 62368; LPS 60950;</p> |              |
|  | <p>Model No. GT-86121-1209-W2</p>  |              |
|  | <p>Part No./Ordering No. WR9HD1330LCP-F(R6B)</p>   | <p>Rev A</p> |

**OUTPUT CONNECTOR HOOK UP**

TO ADDRESS SYSTEM-LEVEL EMI CONCERNS, FERRITE CHOKES/BEADS MAY BE ADDED/REVISED UPON REQUEST. A SAMPLE KIT OF GLOBTEK'S STANDARD FERRITES IS AVAILABLE UNDER GLOBTEK P/N: EMI-MITIGATION-KIT1

FOR ADDITIONAL INFORMATION, PLEASE READ OUR WHITE PAPER AT:

<https://en.globtek.com/technical-articles/ferrite-kit-radiated-emi-suppression-kit-for-globtek-power-supplies-cable-assemblies>

|   |   |
|---|---|
| GlobTek, Inc.<br>www.globtek.com<br>186 Veterans Drive,<br>Northvale, NJ 07647<br>Tel. (201) 784-1000<br>Fax (201) 784-0111 | Drawing Title: GT-86121-1209-W2, ICT/ITE Power Supply, Efficiency Level: USA DOE Level VI / Eco-design Directive 2009/125/EC, (EU) 2019/1782, Case Color/Style: GlobTek Black, Wall Plug-in, Regulated Switchmode AC-DC Power Supply AC Adaptor, Input Rating: 100-240V- , 50/60Hz, N. America NEMA 1-15 Fixed , Output Rating: 12W, 9.0V@1.33A, Output Configuration: 1500 mm, 22/2 Cond, UL 2468, Female Barrel 5.5 * 2.5 * 11mm with internal Spring Clip and Locking Notch or Equal, Ferrite: None, GlobTek Black, GT Cord # C3134, Pin Out: Center Positive (+V), Blades/Input Cord: Fixed Blades North American 1-15P, Approvals: CB 62368; China RoHS; Double Insulation; PSE; PSE; Level VI; RoHS; Ukraine; VCCI; WEEE; cULus; EAC; LPS 62368; LPS 60950; |
|   | Model No. GT-86121-1209-W2<br>Part No./Ordering No. WR9HD1330LCP-F(R6B)   |

LABEL:L-1186

|                                 |  |
|---------------------------------|--|
| LABEL P/N:                      | Standard GT  |
| MATERIAL:                       | Flat Thermal Transfer, Imprintable, Polyester Label and/or Pad Printed and/or Molded, and/or Laser Engraved in the case                    |
| BACKGROUND COLOR:               | Black if housing is Black, White or Silver if housing is White or Gray.  |
| TEXT COLOR:                     | White or Silver if label is Black Background for Black housing. Black if label is White or Silver background and Housing is White or Gray. |
| LABEL WIDTH (mm):               | 39.7   |
| LABEL HEIGHT (mm):              | 16.2   |
| SPECIAL BARCODE LABEL MATERIAL: | No   |

Below is the minimum information which will appear on the label. NOTE: in the logo area additional/actual positioning of symbols and text is subjected to change as per agency updates/requirements or additional model approvals become available. Regulatory certifications/label markings may be in logo area on the label or molded into the case housing outside the label area. Information will be shown via label and/or pad printed and/or molded and/or laser engraved in the case. \* Date code markings at GlobTek option

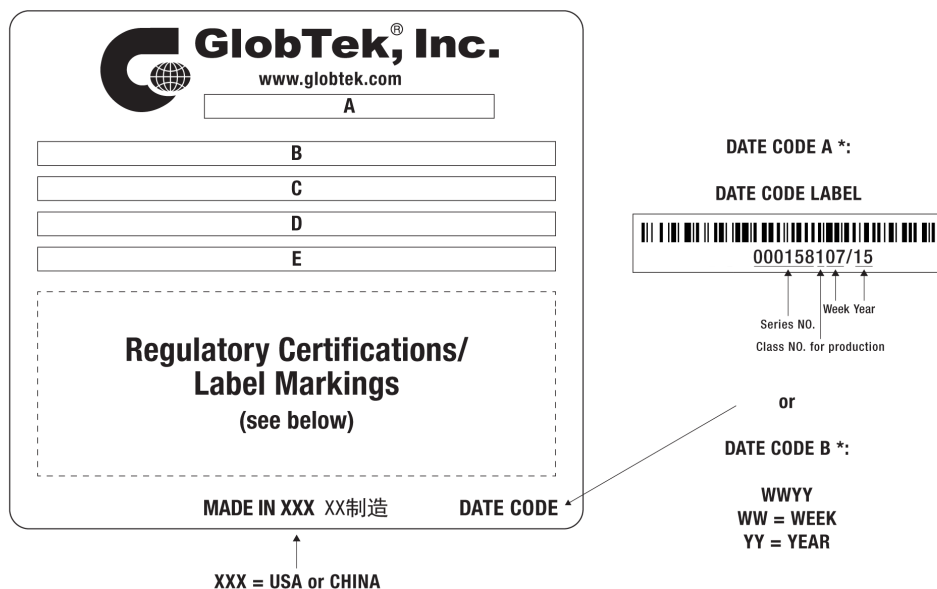

A=ICT/ITE Power Supply  
B=P/N: (料号) WR9HD1330LCP-F(R6B)  
C=Model (型号) GT-86121-1209-W2  
D=Input (输入)100-240V- , 50/60Hz, 0.5A  
E=Output (输出)9.0 V --- 1.33 A, 12.0W

|   |   |              |
|---|---|--------------|
| <p>GlobTek, Inc.<br/>www.globtek.com<br/>186 Veterans Drive,<br/>Northvale, NJ 07647<br/>Tel. (201) 784-1000<br/>Fax (201) 784-0111</p> | <p>Drawing Title: GT-86121-1209-W2, ICT/ITE Power Supply, Efficiency Level: USA DOE Level VI / Eco-design Directive 2009/125/EC, (EU) 2019/1782, Case Color/Style: GlobTek Black, Wall Plug-in, Regulated Switchmode AC-DC Power Supply AC Adaptor, Input Rating: 100-240V- , 50/60Hz, N. America NEMA 1-15 Fixed , Output Rating: 12W, 9.0V@1.33A, Output Configuration: 1500 mm, 22/2 Cond, UL 2468, Female Barrel 5.5 * 2.5 * 11mm with internal Spring Clip and Locking Notch or Equal, Ferrite: None, GlobTek Black, GT Cord # C3134, Pin Out: Center Positive (+V), Blades/Input Cord: Fixed Blades North American 1-15P, Approvals: CB 62368; China RoHS; Double Insulation; PSE; PSE; Level VI; RoHS; Ukraine; VCCI; WEEE; cULus; EAC; LPS 62368; LPS 60950;</p> <p>Model No. GT-86121-1209-W2</p> <p>Part No./Ordering No. WR9HD1330LCP-F(R6B)</p> | <p>Rev A</p> |
|---|---|--------------|

|   |   |
|---|---|
| AGENCY ONLINE DOCUMENTS   | <a href="http://www.globtek.info/certs/GT-86121-WWVV-W2/">http://www.globtek.info/certs/GT-86121-WWVV-W2/</a>   |
| CE EC-Declaration for Medical   | <a href="#">Contact GlobTek for more information</a>  |
| CE EC-Declaration for Industrial/Commercial/ITE   | <a href="http://globtek.force.com/models/ec_declaration_product?id=01t0c000008PAqK&amp;i=2">http://globtek.force.com/models/ec_declaration_product?id=01t0c000008PAqK&amp;i=2</a>           |
| CE EC-Declaration for Household   | <a href="#">Contact GlobTek for more information</a>  |
| UKCA-Declaration for Medical  | <a href="#">Contact GlobTek for more information</a>  |
| UKCA-Declaration for Industrial/Commercial/ITE  | <a href="http://globtek.force.com/models/ukca_declaration_product?id=01t0c000008PAqK&amp;i=2">http://globtek.force.com/models/ukca_declaration_product?id=01t0c000008PAqK&amp;i=2</a>       |
| UKCA-Declaration for Household  | <a href="#">Contact GlobTek for more information</a>  |
| Morocco SDoC Declaration  | <a href="https://globtek.secure.force.com/models/Morocco_SDoC_Declaration?id=a00a000000PSQ1oEAH">https://globtek.secure.force.com/models/Morocco_SDoC_Declaration?id=a00a000000PSQ1oEAH</a> |
| RoHS/RoHS3 Declaration  | <a href="https://www.globtek.com/pdf/rohs_cert/01t0c000008PAqKAAW">https://www.globtek.com/pdf/rohs_cert/01t0c000008PAqKAAW</a>   |
| REACH Declaration   | <a href="https://www.globtek.com/pdf/iso_certificates/REACH.pdf">https://www.globtek.com/pdf/iso_certificates/REACH.pdf</a>   |
| Conflict Minerals Declaration   | <a href="https://www.globtek.com/pdf/conflict-minerals.pdf">https://www.globtek.com/pdf/conflict-minerals.pdf</a>   |
| Prop 65 Statement   | <a href="https://en.globtek.com/prop-65-statement.pdf">https://en.globtek.com/prop-65-statement.pdf</a>   |
| IPXY rating is based on 3rd party testing and customers should check suitability and test system level IPXY rating before ordering. |   |

## Regulatory Certifications/Label Markings

LATEST PRODUCT/MODEL CERTIFICATIONS: <https://en.globtek.com/datasheet/id/a00a000000PSQ1o>

AGENCY ONLINE DOCUMENTS: <http://www.globtek.info/certs/GT-86121-WWVV-W2/>



(F1) Class II / Double Insulated

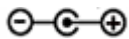

Center Positive (+V)

|   |   |              |
|---|---|--------------|
| <p>GlobTek, Inc.<br/>www.globtek.com<br/>186 Veterans Drive,<br/>Northvale, NJ 07647<br/>Tel. (201) 784-1000<br/>Fax (201) 784-0111</p> | <p>Drawing Title: GT-86121-1209-W2, ICT/ITE Power Supply, Efficiency Level: USA DOE Level VI / Eco-design Directive 2009/125/EC, (EU) 2019/1782, Case Color/Style: GlobTek Black, Wall Plug-in, Regulated Switchmode AC-DC Power Supply AC Adaptor, Input Rating: 100-240V- , 50/60Hz, N. America NEMA 1-15 Fixed , Output Rating: 12W, 9.0V@1.33A, Output Configuration: 1500 mm, 22/2 Cond, UL 2468, Female Barrel 5.5 * 2.5 * 11mm with internal Spring Clip and Locking Notch or Equal, Ferrite: None, GlobTek Black, GT Cord # C3134, Pin Out: Center Positive (+V), Blades/Input Cord: Fixed Blades North American 1-15P, Approvals: CB 62368; China RoHS; Double Insulation; PSE; PSE; Level VI; RoHS; Ukraine; VCCI; WEEE; cULus; EAC; LPS 62368; LPS 60950;</p> <p>Model No. GT-86121-1209-W2</p> <p>Part No./Ordering No. WR9HD1330LCP-F(R6B)</p> | <p>Rev A</p> |
|---|---|--------------|

## PACKAGING

|                                  |   |
|----------------------------------|---|
| Packing Spec P/N:                | Standard WPI, Individually Box, User manual DT  |
| Box Qty:                         | 120   |
| Gift Box Size (mm):              | 90*48*62  |
| Gift Box Color:                  | White   |
| Master Carton Size (mm):         | 470 x 310 x 284   |
| Master Carton Cubic Volume (m³): | 0.04  |
| Master GW (Kg):                  | 15.6 kg   |
| BLADES INCLUDED:                 | FBNA2: Fixed Blades North American 1-15P  |
| BLADE/CORD INSTALLED:            | FBNA2: Fixed Blades North American 1-15P  |
| USER MANUAL*:                    | 809-DESKTOPUSERMANUAL on A4 paper   |
| USER MANUAL WEB LINK:            | <a href="https://en.globtek.com/pdf/809-DESKTOPUSERMANUAL.jpg">https://en.globtek.com/pdf/809-DESKTOPUSERMANUAL.jpg</a> |

\* This specification sheet is considered the user manual for all applications. It is expected that the buyer of this product will use it to formulate their own user manual for their end product and a user manual specifically for the power adapter is not usually required. If a user manual is not specifically listed above then none will be provided with this unit.

|  |  |              |
|--|--|--------------|
| <p>GlobTek, Inc.<br/> www.globtek.com<br/> 186 Veterans Drive,<br/> Northvale, NJ 07647<br/> Tel. (201) 784-1000<br/> Fax (201) 784-0111</p> | <p>Drawing Title: GT-86121-1209-W2, ICT/ITE Power Supply, Efficiency Level: USA DOE Level VI / Eco-design Directive 2009/125/EC, (EU) 2019/1782, Case Color/Style: GlobTek Black, Wall Plug-in, Regulated Switchmode AC-DC Power Supply AC Adaptor, Input Rating: 100-240V- , 50/60Hz, N. America NEMA 1-15 Fixed , Output Rating: 12W, 9.0V@1.33A, Output Configuration: 1500 mm, 22/2 Cond, UL 2468, Female Barrel 5.5 * 2.5 * 11mm with internal Spring Clip and Locking Notch or Equal, Ferrite: None, GlobTek Black, GT Cord # C3134, Pin Out: Center Positive (+V), Blades/Input Cord: Fixed Blades North American 1-15P, Approvals: CB 62368; China RoHS; Double Insulation; PSE; PSE; Level VI; RoHS; Ukraine; VCCI; WEEE; cULus; EAC; LPS 62368; LPS 60950;</p> |              |
|  | <p>Model No. GT-86121-1209-W2</p>  |              |
|  | <p>Part No./Ordering No. WR9HD1330LCP-F(R6B)</p>   | <p>Rev A</p> |

If specific packaging is required, this section must specify all requirements and note "no exceptions". If this section does not specify packaging, it is subject to change without notice at GlobTek's discretion

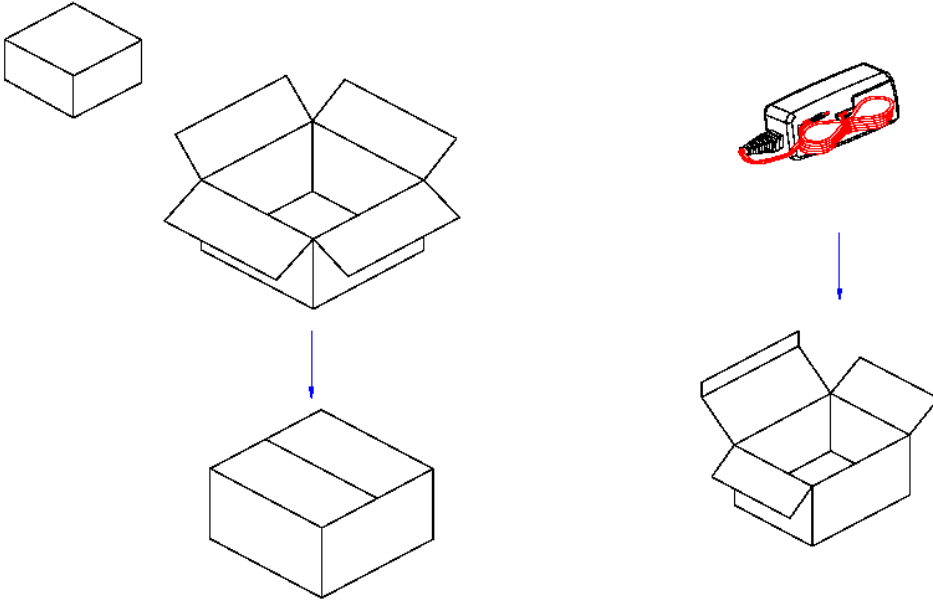

|   |  |              |
|---|--|--------------|
| <p>GlobTek, Inc.<br/>www.globtek.com<br/>186 Veterans Drive,<br/>Northvale, NJ 07647<br/>Tel. (201) 784-1000<br/>Fax (201) 784-0111</p> | <p>Drawing Title: GT-86121-1209-W2, ICT/ITE Power Supply, Efficiency Level: USA DOE Level VI / Eco-design Directive 2009/125/EC, (EU) 2019/1782, Case Color/Style: GlobTek Black, Wall Plug-in, Regulated Switchmode AC-DC Power Supply AC Adaptor, Input Rating: 100-240V- , 50/60Hz, N. America NEMA 1-15 Fixed , Output Rating: 12W, 9.0V@1.33A, Output Configuration: 1500 mm, 22/2 Cond, UL 2468, Female Barrel 5.5 * 2.5 * 11mm with internal Spring Clip and Locking Notch or Equal, Ferrite: None, GlobTek Black, GT Cord # C3134, Pin Out: Center Positive (+V), Blades/Input Cord: Fixed Blades North American 1-15P, Approvals: CB 62368; China RoHS; Double Insulation; PSE; PSE; Level VI; RoHS; Ukraine; VCCI; WEEE; cULus; EAC; LPS 62368; LPS 60950;</p> |              |
|   | <p>Model No. GT-86121-1209-W2</p>  |              |
|   | <p>Part No./Ordering No. WR9HD1330LCP-F(R6B)</p>   | <p>Rev A</p> |

## INSTRUCTIONS TO THE OEM SYSTEMS ENGINEER

It is the responsibility of the OEM systems engineer to provide the end system user instructions and warnings for the use of this product in the end system.

If an input cord is required for this product, AC Mains voltage should be provided to the power supply by a power supply cord approved to the national standards of the country in which it will be used.

This power supply is not designed to be repaired. No serviceable parts inside. A blown internal fuse is an indication of catastrophic failure of circuit component(s). If a Failure Analysis is required for a failed power supply/battery charger, please return the damaged unit to GlobTek for an accurate determination of the root cause of the failure.

EMC Compliance of the complete OEM product, including the GlobTek power supply/battery charger needs to be verified by the OEM systems engineer.

## INSTRUCTION SHEET

N/A