

GlobTek, Inc. www.globtek.com 186 Veterans Drive, Northvale, NJ 07647 Tel. (201) 784-1000 Fax (201) 784-0111	Drawing Title: GTM96900P9024-T3, ITE / Medical Power Supply/Class 2/Household Power Supply, Efficiency Level: VI, Case Color/Style: GlobTek Black, Desktop/External, Regulated Switchmode AC-DC Power Supply AC Adaptor, Input Rating: 100-240V~, 50-60Hz, IEC 60320/C14 , Output Rating: 90W, 24V@3.75A, Output Configuration: 1500 mm, 18/2 Cond, UL 2468, Female Barrel 5.5*2.1*11mm w/ Spring Clip & Locking Notch or Equal, Ferrite: None, GlobTek Black, GT Cord # C16021, Pin Out: Center Positive (+V), Blades/Input Cord: Not Applicable, Approvals: CB 61347; RCM; LPS; CCC; Patent US9838207B2; VCCI; EAC; IP41; cETLus; UL 1310; cETLus; CB 60950; ETL; ETL; CB 60335; S-Mark 60950; CB 62368; ETL; CB 60601-1; S-Mark; CE; China RoHS; Class I; Level VI; RoHS; Ukraine; WEEE; PSE; PSE; PSE;	
	Model No. GTM96900P9024-T3	
	Part No./Ordering No. TR9CI3750CPCIMR6BLPS	Rev C

## REVISION HISTORY

REV	DESCRIPTION	SUB	DATE	APPROVED
C	Update Grounding configuration to F2	QA	11/27/2018	QA
B	Correct I/P configuration from IEC 60320/C8 to IEC 60320/C14 (error in spec) Update individual box packing to Cellular packaging	QA	11/19/2018	QA
A	Initial Release	bsiep	02/19/2018	QA

In Addition to GlobTek Inc.'s renewed ISO9001:2015 - Quality Management System Certification, GlobTek Inc. is now certified to:

ISO13485:2016 - Medical Devices Quality Management System Certification  
ISO14001:2015 - Environmental Management System Certification

ISO Certificates are available online at <https://www.globtek.com/iso-certificates/>

### Customer Approval of Specification:

Please approve, sign and send back to GlobTek so we can complete order processing.

A delay in receipt of this form will delay delivery schedule.

Company Name:

Customer P/N:

Quote Number:

Date:

Authorized Representative Name:

Authorized Representative Signature:

The acceptance of this specification and use of the product described in this document indicates the acceptance and binding of the customer to Globtek terms and conditions, which supersede all other agreements, terms, and conditions (<https://en.globtek.com/terms-and-conditions/>).

### Footnote:

GlobTek Inc. will not be liable for the safety and performance of these power supplies if unauthorized access and repair occurs. End user should consult applicable UL, CSA or EN standards for proper installation instruction.

### Limitation of Use:

GlobTek products are intended for use with commercial, medical, and/or industrial equipment only. GlobTek product are not authorized for use as mission critical components in life support hazardous environment, nuclear or aircraft applications without prior written approval from the CEO of GlobTek Inc.  
Contents of this document are subject to change without prior notice.

GlobTek, Inc. www.globtek.com 186 Veterans Drive, Northvale, NJ 07647 Tel. (201) 784-1000 Fax (201) 784-0111	Drawing Title: GTM96900P9024-T3, ITE / Medical Power Supply/Class 2/Household Power Supply, Efficiency Level: VI, Case Color/Style: GlobTek Black, Desktop/External, Regulated Switchmode AC-DC Power Supply AC Adaptor, Input Rating: 100-240V~, 50-60Hz, IEC 60320/C14 , Output Rating: 90W, 24V@3.75A, Output Configuration: 1500 mm, 18/2 Cond, UL 2468, Female Barrel 5.5*2.1*11mm w/ Spring Clip & Locking Notch or Equal, Ferrite: None, GlobTek Black, GT Cord # C16021, Pin Out: Center Positive (+V), Blades/Input Cord: Not Applicable, Approvals: CB 61347; RCM; LPS; CCC; Patent US9838207B2; VCCI; EAC; IP41; cETLus; UL 1310; cETLus; CB 60950; ETL; ETL; CB 60335; S-Mark 60950; CB 62368; ETL; CB 60601-1; S-Mark; CE; China RoHS; Class I; Level VI; RoHS; Ukraine; WEEE; PSE; PSE; PSE;	
	Model No. GTM96900P9024-T3	
	Part No./Ordering No. TR9CI3750CPCIMR6BLPS	Rev C

## POWER SUPPLY INFORMATION

TYPE:	Desktop/External
TECHNOLOGY:	Regulated Switchmode AC-DC Power Supply AC Adaptor
CASE COLOR:	GlobTek Black
NAMEPLATE RATED INPUT:	100-240V~, 50-60Hz, 1.5A
INPUT CONFIG:	IEC 60320/C14
WATTS:	90.0
VOLTS OUT:	24
CURRENT OUT (Amps):	3.75
BLADE/CORD INCLUDED:	N/A
BLADE/CORD INSTALLED:	N/A
INGRESS PROTECTION:	IP41
GROUNDING CONFIGURATION:	(F2) Isolated Functional Earth for GTM96 series, Improved EMC
EFFICIENCY LEVEL:	VI
OUTPUT CONFIGURATION:	1500 mm, 18/2 Cond, UL 2468, Female Barrel 5.5*2.1*11mm w/ Spring Clip & Locking Notch or Equal, Ferrite: None, GlobTek Black, GT Cord # C16021
OVERMOLDED:	Yes
CONNECTOR PIN OUT:	Center Positive (+V)
LABEL SPECS:	Standard GT,L-1186
SPECIAL BARCODE LABEL	
MATERIAL:	No
PACK SPEC:	Standard DT, Cellular packaging, User manual
USER MANUAL:	809-DESKTOPUSERMANUAL

Notes/Modifications/Customizations (notes in this section supersede the values shown in the standard spec):



follow RFP RFI-497430 for LPS

DIMENSIONS ARE IN MM UNLESS SPECIFIED OTHERWISE.

### PROPRIETARY INFORMATION

PROPRIETARY OF GLOBTEK, INC. ANY REPRODUCTION, DISCLOSURE OR USE OF THIS DRAWING, IN WHOLE OR IN PART, IS HEREBY PROHIBITED EXCEPT AS SPECIFIED IN WRITING BY GLOBTEK, INC. © GlobTek, Inc. 2018 - 2019

GloTek, Inc. www.globtek.com 186 Veterans Drive, Northvale, NJ 07647 Tel. (201) 784-1000 Fax (201) 784-0111	Drawing Title: GTM96900P9024-T3, ITE / Medical Power Supply/Class 2/Household Power Supply, Efficiency Level: VI, Case Color/Style: GlobTek Black, Desktop/External, Regulated Switchmode AC-DC Power Supply AC Adaptor, Input Rating: 100-240V~, 50-60Hz, IEC 60320/C14 , Output Rating: 90W, 24V@3.75A, Output Configuration: 1500 mm, 18/2 Cond, UL 2468, Female Barrel 5.5*2.1*11mm w/ Spring Clip & Locking Notch or Equal, Ferrite: None, GlobTek Black, GT Cord # C16021, Pin Out: Center Positive (+V), Blades/Input Cord: Not Applicable, Approvals: CB 61347; RCM; LPS; CCC; Patent US9838207B2; VCCI; EAC; IP41; cETLus; UL 1310; cETLus; CB 60950; ETL; ETL; CB 60335; S-Mark 60950; CB 62368; ETL; CB 60601-1; S-Mark; CE; China RoHS; Class I; Level VI; RoHS; Ukraine; WEEE; PSE; PSE; PSE;	
	Model No. GTM96900P9024-T3	
	Part No./Ordering No. TR9CI3750CPCIMR6BLPS	Rev C

## ELECTRICAL SPECIFICATIONS

### A) ELECTRICAL SPECIFICATIONS:

01. Input Voltage: Specified 90-264 Vac, Nameplate rated: 100-240Vac  
90-264Vac range @ 100% of rated load current  
85-264 Vac range @ 90% of rated load current  
90-370 VDC range @ 100% of rated load current
02. Input Frequency: Specified 47-63 Hz, Nameplate rated 50/60Hz
03. Power Factor: 0.90 minimum @ 230Vac, 0.97 minimum @ 115Vac
04. Output Type: LPS (Limited Power Source), limited to less than 8A and 100W
04. Output Regulation: +/- 4% measured at the output connector
05. Line Voltage Regulation: +/- 0.5% typical measured at full load
06. Green Power On Indicator LED
07. Output Ripple (Vp-p): 1% or 200 mV whichever is greater, measured at 20 MHz bandwidth with 0.1 uf ceramic capacitor in parallel with a low impedance 47 uf electrolytic capacitor connected at the end of the output connector at nominal line
08. Turn-ON/OFF Overshoot: 5% maximum, 1 mS typical recovery time for 25% to 50% step load
09. Turn-ON Delay: 1 second typical
10. Hold-Up Time: 20 mS minimum
11. Inrush Current: 30A maximum at 115Vac input and 60A maximum at 230 Vac input
12. Switching Frequency: Varies from 25KHz to 125KHz
13. Efficiency: Compliant with Efficiency Level VI Standard and 230 CoC Tier 2 Limits
14. No Load Standby Power: <0.15 W @ 230Vac

### B) PROTECTION

01. Input Protection: Input line fusing and 300Vac rated MOV
02. Non-LPS version: Current Limited to 110% to 160% of rated output current
03. LPS version: Short Circuit/Overload limited to less than 8A and 100W (add Z suffix in model #)
04. Over-Temperature : Inherently protected against continuous overload at high temperature
05. Output Over-Voltage: 110% to 135% of nominal output voltage under full load condition, and less than 60V max. Latching protection, cycle AC OFF to reset.

### C) SAFETY

01. Dielectric Withstand Voltage: 4000Vac or 5656Vdc from input to output, On Class I models, 3000Vac or 4242Vdc from input to earth
02. Earth Leakage Current: Class I models < 300uA, N/A for Class II models
03. Touch Current: Class I models < 20uA, Class II models < 70uA
04. [Output Isolation Options:](#)
  - a) C8 or C18 Inlet, Class II
  - b) C6 or C14 Inlet, Class II FE, Output Isolated from Earth contact
  - c) C6 or C14 Inlet, Class I, Output negative directly attached to Earth contact
05. Earth Continuity Test: < 0.1 Ohm between Earth Pin at AC input and PCB termination point (Class I models only)
06. Means of Protection: 2 x MOPP
07. Primary to Secondary Bridging Capacitance: Two IEC60384-14 certified Y1 type capacitors in series
08. Compliant Standards: See listings at end of this drawing for specifics

### D) EMC

EN 60601-1-2, 4<sup>th</sup> edition  
Emissions, per EN 55032, EN 61000-6-3, EN 61000-6-4, CISPR11 and CISPR22

#### PROPRIETARY INFORMATION

PROPRIETARY OF GLOBTEK, INC. ANY REPRODUCTION, DISCLOSURE OR USE OF THIS DRAWING, IN WHOLE OR IN PART, IS HEREBY PROHIBITED EXCEPT AS SPECIFIED IN

WRITING BY GLOBTEK, INC. © GlobTek, Inc. 2018 - 2019

quest /05/20/2019 2:37:49 PM CLONED FROM TR9KE7500CCP-IM(R6B)

GloTek, Inc. www.globtek.com 186 Veterans Drive, Northvale, NJ 07647 Tel. (201) 784-1000 Fax (201) 784-0111	Drawing Title: GTM96900P9024-T3, ITE / Medical Power Supply/Class 2/Household Power Supply, Efficiency Level: VI, Case Color/Style: GlobTek Black, Desktop/External, Regulated Switchmode AC-DC Power Supply AC Adaptor, Input Rating: 100-240V~, 50-60Hz, IEC 60320/C14, Output Rating: 90W, 24V@3.75A, Output Configuration: 1500 mm, 18/2 Cond, UL 2468, Female Barrel 5.5*2.1*11mm w/ Spring Clip & Locking Notch or Equal, Ferrite: None, GlobTek Black, GT Cord # C16021, Pin Out: Center Positive (+V), Blades/Input Cord: Not Applicable, Approvals: CB 61347; RCM; LPS; CCC; Patent US9838207B2; VCCI; EAC; IP41; cETLus; UL 1310; cETLus; CB 60950; ETL; ETL; CB 60335; S-Mark 60950; CB 62368; ETL; CB 60601-1; S-Mark; CE; China RoHS; Class I; Level VI; RoHS; Ukraine; WEEE; PSE; PSE; PSE;	
	Model No. GTM96900P9024-T3	
	Part No./Ordering No. TR9CI3750CPCIMR6BLPS	Rev C

Conducted Emissions: Class B, FCC Part 15, Class B  
Radiated Emissions: Class B, FCC Part 15, Class B  
Line Frequency Harmonics EN61000-3-2, Class A  
Voltage Fluctuations/Flicker EN61000-3-3

Immunity, per EN 55024, EN 61000-6-1, EN 61000-6-2

Static Discharge Immunity EN61000-4-2, 10kV Contact Discharge, 18kV air discharge  
Radiated RF Immunity EN61000-4-3, 10V/m 80-1000MHz, 3V/m 1-2.7GHz, 80% 1KHz AM.  
EFT/Burst Immunity EN61000-4-4, 4kV/100kHz.  
Line Surge Immunity EN61000-4-5, 2kV differential, 4kV common-mode  
Conducted RF Immunity EN61000-4-6, 3Vrms, 80% 1KHz AM  
Power Frequency Magnetic Field Immunity EN61000-4-8, 3A/m  
Voltage Dip Immunity EN61000-4-11, Criteria

E) OTHER:

01. MTBF: 1,000,000 Hours @ 40°C ambient temperature, Full Load
02. Operating Temperature:
  - GTM96900P Family: 0°C to 50°C ambient temperature with full load
  - Regarding Operating Temperature,
    - a- See below derating table for output power capability at alternate temperature
    - b- Extended low end temperature range available as custom option
03. Humidity: 0% to 95% relative humidity, non-condensing
04. Storage Temperature: -30°C to 80°C
05. Cooling: Convection
06. ROHS: Compliant with latest regulations, see approvals section below
07. Operational Altitude: 5000M

F) DESKTOP STYLE ENCLOSURE

01. Housing: High impact plastic, 94V0 polycarbonate, non-vented
02. Size: 149.4 x 62.6 x 33.5 +/-1.0 mm
03. Markings: Label or Laser printed
04. AC Input mechanical options: Desktop C6, C8, C14 or C18 IEC Inlet.

G) SPECIAL OPTIONS

01. LPS or non-LPS versions (Z suffix for LPS model)
02. Custom Cordsets, various cordage types, and connector types
03. Custom Markings
04. Short term Output Surge Capability, as a non-LPS version
05. Reduced Leakage Current version, medical CF leakage current compliance
06. Tightened output voltage tolerance
07. Reduced Output Ripple Level
08. Reduced output power Marking/Rating
09. LED Lighting, Class C Line Harmonics per 61000-3-2
  - Three Power Ranges available: 27-50W, 40-65W and 57-90W
10. High Rel PCB laminate with Plated through Holes for IPC610 Class 2 Compliance
11. Low Temperature operation, down to -40°C
12. Special Housing Colors and Cordset Colors
13. Epoxy Potted Version, "P2" or "P3" suffix, with flying wires
14. Back EMF applications, custom solutions. For unusual motor load aps and other high inductance reverse energy flow requirements

PROPRIETARY INFORMATION

PROPRIETARY OF GLOBTEK, INC. ANY REPRODUCTION, DISCLOSURE OR USE OF THIS DRAWING, IN WHOLE OR IN PART, IS HEREBY PROHIBITED EXCEPT AS SPECIFIED IN

WRITING BY GLOBTEK, INC. © GlobTek, Inc. 2018 - 2019

quest /05/20/2019 2:37:49 PM CLONED FROM TR9KE7500CCP-IM(R6B)

GlobTek, Inc. www.globtek.com 186 Veterans Drive, Northvale, NJ 07647 Tel. (201) 784-1000 Fax (201) 784-0111	Drawing Title: GTM96900P9024-T3, ITE / Medical Power Supply/Class 2/Household Power Supply, Efficiency Level: VI, Case Color/Style: GlobTek Black, Desktop/External, Regulated Switchmode AC-DC Power Supply AC Adaptor, Input Rating: 100-240V~, 50-60Hz, IEC 60320/C14, Output Rating: 90W, 24V@3.75A, Output Configuration: 1500 mm, 18/2 Cond, UL 2468, Female Barrel 5.5*2.1*11mm w/ Spring Clip & Locking Notch or Equal, Ferrite: None, GlobTek Black, GT Cord # C16021, Pin Out: Center Positive (+V), Blades/Input Cord: Not Applicable, Approvals: CB 61347; RCM; LPS; CCC; Patent US9838207B2; VCCI; EAC; IP41; cETLus; UL 1310; cETLus; CB 60950; ETL; ETL; CB 60335; S-Mark 60950; CB 62368; ETL; CB 60601-1; S-Mark; CE; China RoHS; Class I; Level VI; RoHS; Ukraine; WEEE; PSE; PSE; PSE;	
	Model No. GTM96900P9024-T3	
	Part No./Ordering No. TR9CI3750CPCIMR6BLPS	Rev C

### 15. Improved Ingress Protection Rating

#### H) OUTPUT CONNECTORS

Several output connector options are available with various output current ratings.

GlobTek can supply 10A rated 2.1mm and 2.5mm style DC Power Jacks, to complement our

10A output rated 2.1mm and 2.5mm DC power plugs used on our output cordsets.

Please visit <https://en.globtek.com/news/high-current-coaxial-barrel-plug-jacks-for-high-wattage-power-supplies> for a real time product offering of mating connectors.

INGRESS PROTECTION: IP41

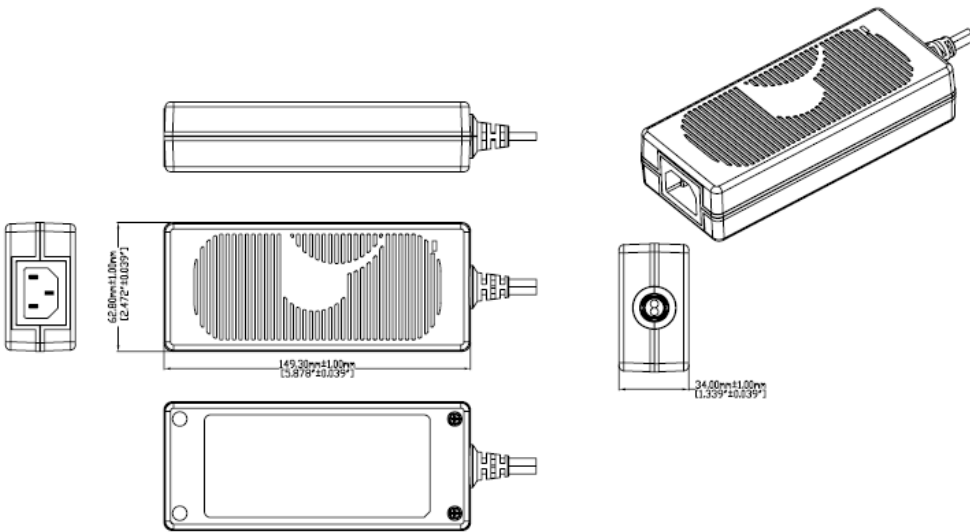

#### DERATING CURVE

<p>GlobTek, Inc. www.globtek.com 186 Veterans Drive, Northvale, NJ 07647 Tel. (201) 784-1000 Fax (201) 784-0111</p>	<p>Drawing Title: GTM96900P9024-T3, ITE / Medical Power Supply/Class 2/Household Power Supply, Efficiency Level: VI, Case Color/Style: GlobTek Black, Desktop/External, Regulated Switchmode AC-DC Power Supply AC Adaptor, Input Rating: 100-240V~, 50-60Hz, IEC 60320/C14 , Output Rating: 90W, 24V@3.75A, Output Configuration: 1500 mm, 18/2 Cond, UL 2468, Female Barrel 5.5*2.1*11mm w/ Spring Clip &amp; Locking Notch or Equal, Ferrite: None, GlobTek Black, GT Cord # C16021, Pin Out: Center Positive (+V), Blades/Input Cord: Not Applicable, Approvals: CB 61347; RCM; LPS; CCC; Patent US9838207B2; VCCI; EAC; IP41; cETLus; UL 1310; cETLus; CB 60950; ETL; ETL; CB 60335; S-Mark 60950; CB 62368; ETL; CB 60601-1; S-Mark; CE; China RoHS; Class I; Level VI; RoHS; Ukraine; WEEE; PSE; PSE; PSE;</p>	
	<p>Model No. GTM96900P9024-T3</p>	
	<p>Part No./Ordering No. TR9CI3750CPCIMR6BLPS</p>	<p>Rev C</p>

**TYPICAL EXTERNAL POWER SUPPLY DERATING CURVE**

(GTM96900 LPS PRODUCTS)

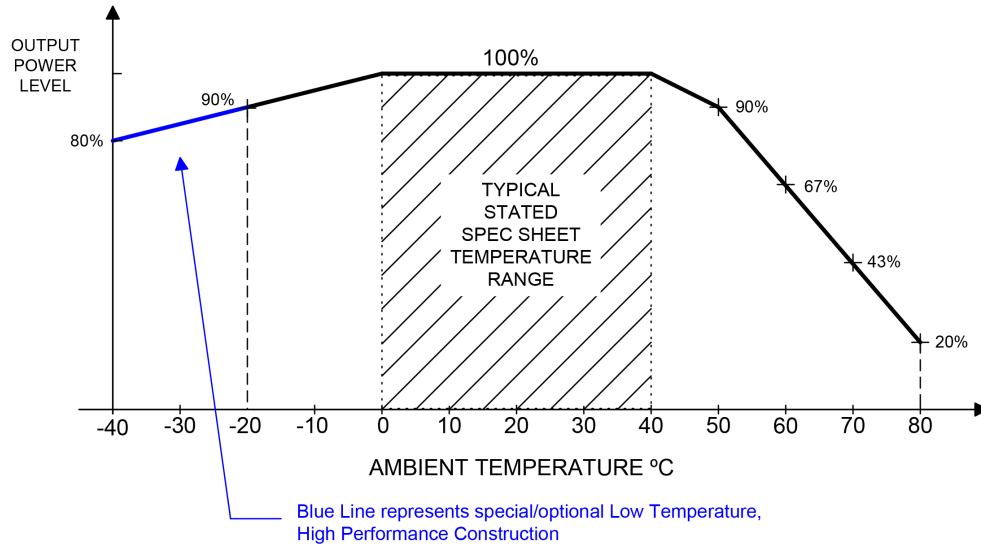

PROPRIETARY INFORMATION

PROPRIETARY OF GLOBTEK, INC. ANY REPRODUCTION, DISCLOSURE OR USE OF THIS DRAWING, IN WHOLE OR IN PART, IS HEREBY PROHIBITED EXCEPT AS SPECIFIED IN WRITING BY GLOBTEK, INC. © GlobTek, Inc. 2018 - 2019

GlobTek, Inc. www.globtek.com 186 Veterans Drive, Northvale, NJ 07647 Tel. (201) 784-1000 Fax (201) 784-0111	Drawing Title: GTM96900P9024-T3, ITE / Medical Power Supply/Class 2/Household Power Supply, Efficiency Level: VI, Case Color/Style: GlobTek Black, Desktop/External, Regulated Switchmode AC-DC Power Supply AC Adaptor, Input Rating: 100-240V~, 50-60Hz, IEC 60320/C14, Output Rating: 90W, 24V@3.75A, Output Configuration: 1500 mm, 18/2 Cond, UL 2468, Female Barrel 5.5*2.1*11mm w/ Spring Clip & Locking Notch or Equal, Ferrite: None, GlobTek Black, GT Cord # C16021, Pin Out: Center Positive (+V), Blades/Input Cord: Not Applicable, Approvals: CB 61347; RCM; LPS; CCC; Patent US9838207B2; VCCI; EAC; IP41; cETLus; UL 1310; cETLus; CB 60950; ETL; ETL; CB 60335; S-Mark 60950; CB 62368; ETL; CB 60601-1; S-Mark; CE; China RoHS; Class I; Level VI; RoHS; Ukraine; WEEE; PSE; PSE; PSE;	
	Model No. GTM96900P9024-T3	
	Part No./Ordering No. TR9CI3750CPCIMR6BLPS	Rev C

## INPUT CONFIGURATION

(F2) Isolated Functional Earth for GTM96 series, Improved EMC

GTM96XXX Optional Config

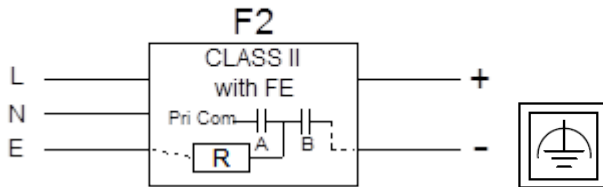

[Alternate grounding configurations](#) available upon request.

Blades/Cord Included:N/A:

Blades/Cord Installed:N/A:

IEC 60320/C14 AC Inlet Connector, Class I, Earth Ground

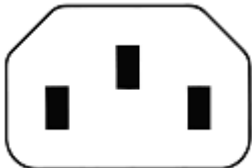

Mates with IEC 60320/C13 Plug

Optional Locking IEC60320 Receptacle and cord option available on some models by request.:



### [Standard International IEC 320/C13 Cordsets](#)

Below are standard cordsets which are "not included" (unless stated above); these can be purchased separately or packaged with the power supply. Contact your Sales Engineer if the style required is not shown below. Many more available in different lengths, colors or cable material.

## Stock Power Supply Cords

Part Number/ Link	Country	Plug	Termination	Length (mm)	(Ft)

### PROPRIETARY INFORMATION

PROPRIETARY OF GLOBTEK, INC. ANY REPRODUCTION, DISCLOSURE OR USE OF THIS DRAWING, IN WHOLE OR IN PART, IS HEREBY PROHIBITED EXCEPT AS SPECIFIED IN

WRITING BY GLOBTEK, INC. © GlobTek, Inc. 2018 - 2019

quest /05/20/2019 2:37:49 PM CLONED FROM TR9KE7500CCP-IM(R6B)

GlobTek, Inc. www.globtek.com 186 Veterans Drive, Northvale, NJ 07647 Tel. (201) 784-1000 Fax (201) 784-0111	Drawing Title: GTM96900P9024-T3, ITE / Medical Power Supply/Class 2/Household Power Supply, Efficiency Level: VI, Case Color/Style: GlobTek Black, Desktop/External, Regulated Switchmode AC-DC Power Supply AC Adaptor, Input Rating: 100-240V~, 50-60Hz, IEC 60320/C14 , Output Rating: 90W, 24V@3.75A, Output Configuration: 1500 mm, 18/2 Cond, UL 2468, Female Barrel 5.5*2.1*11mm w/ Spring Clip & Locking Notch or Equal, Ferrite: None, GlobTek Black, GT Cord # C16021, Pin Out: Center Positive (+V), Blades/Input Cord: Not Applicable, Approvals: CB 61347; RCM; LPS; CCC; Patent US9838207B2; VCCI; EAC; IP41; cETLus; UL 1310; cETLus; CB 60950; ETL; ETL; CB 60335; S-Mark 60950; CB 62368; ETL; CB 60601-1; S-Mark; CE; China RoHS; Class I; Level VI; RoHS; Ukraine; WEEE; PSE; PSE; PSE;	
	Model No. GTM96900P9024-T3	
	Part No./Ordering No. TR9CI3750CPCIMR6BLPS	Rev C

<a href="#">3021457F701(R)</a>	N. American (Type B)	NEMA 5-15P	IEC 320/C13	2150	7
<a href="#">1191068F0701(R)</a>	N. American (Type B)	NEMA 5-15P Hospital	IEC 320/C13	2459	8
<a href="#">2194272M5701-T(R)</a>	Argentina (Type I)	IRAM 2073	IEC 320/C13	2500	8
<a href="#">5502022M5701A(R)</a>	Australian (Type I)	AS3112 / 3 PRONG	IEC 320/C13	2500	8
<a href="#">204B4272M5701(R)</a>	Brazil (Type N)	BRAZIL	IEC 320/C13	2500	8
<a href="#">6023602M5701(R)</a>	China (Type I)	CCC GR2099	IEC 320/C13	2500	8
<a href="#">G8014272M5701(R)</a>	Danish (Type K)	AFSNIT SECTION 107-2-D1	IEC 320/C13	2500	8
<a href="#">23144272M5701-T(R)</a>	Europe (Type E)	CEE 7/7	IEC 320/C13	2500	8
<a href="#">205IN4272M5701(R)</a>	India (Type D)	India IS 1293 (also known as IA16A3 or BS546)	IEC 320/C13	2500	8
<a href="#">208IN4272M5701(R)</a>	India (Type M)	India IS 1293 (also known as IA16A3 or BS546)	IEC320/C13	2500	8
<a href="#">377C4272M5701(R)</a>	Israel (Type H)	ISL 377C	IEC 320/C13	2500	8
<a href="#">23024272M5701(R)</a>	Italy (Type L)	CEI 23-16/VII	IEC 320/C13	2500	8
<a href="#">3003339F701(R)</a> [3x1.25mm2]	Japan (Type B)	JIS 8303 / 3 PINS	IEC 320/C13	2500	8
<a href="#">3003068F2701-HK(R)</a> [3 x 2.0mm2]					
<a href="#">302J115J6F0701J(R)</a>	Japan / North America (Type B – 12A)	JIS 8303 / 3 PINS and NEMA 5-15P (PSE and UL/CUL appr)	IEC 320/C13	1830	6
<a href="#">302J104J6F0701J(R)</a>	Japan / North America (Type B – 15A)	JIS 8303 / 3 PINS and NEMA 5-15P (PSE and UL/CUL appr)	IEC 320/C13	1830	6
<a href="#">2313K3432M5701(R)</a>	Korea (Type F)	KS C 8305	IEC 320/C13	2500	8
<a href="#">5804272M5701(R)</a>	Russia (Type F)	GOST 7396	IEC 320/C13	2500	8
<a href="#">205SA4272M5701(R)</a>	South Africa (Type D)	South Africa SABS164-1 (6A type)	IEC 320/C13	2500	8
<a href="#">2084272M5701(R)</a>	South Africa (Type M)	South Africa SABS164-1 (16A type)	IEC 320/C13	2500	8
<a href="#">23214272M5701(R)</a>	Switzerland (Type J)	SEV 1011	IEC 320/C13	2500	8
<a href="#">3003322M5701(R)</a>	Taiwan (Type B)	BSMI	IEC 320/C13	2500	8
<a href="#">PZ0800100-2M5BK13H(R)</a>	UK, Hong Kong, Singapore, Gulf States (Type G)	BS 1363A	IEC 320/C13	2500	8
<a href="#">7055002M5701A(R)</a>	International	IEC 320 C14-C13	IEC 320/C13	2500	8



GlobTek, Inc. www.globtek.com 186 Veterans Drive, Northvale, NJ 07647 Tel. (201) 784-1000 Fax (201) 784-0111	Drawing Title: GTM96900P9024-T3, ITE / Medical Power Supply/Class 2/Household Power Supply, Efficiency Level: VI, Case Color/Style: GlobTek Black, Desktop/External, Regulated Switchmode AC-DC Power Supply AC Adaptor, Input Rating: 100-240V~, 50-60Hz, IEC 60320/C14 , Output Rating: 90W, 24V@3.75A, Output Configuration: 1500 mm, 18/2 Cond, UL 2468, Female Barrel 5.5*2.1*11mm w/ Spring Clip & Locking Notch or Equal, Ferrite: None, GlobTek Black, GT Cord # C16021, Pin Out: Center Positive (+V), Blades/Input Cord: Not Applicable, Approvals: CB 61347; RCM; LPS; CCC; Patent US9838207B2; VCCI; EAC; IP41; cETLus; UL 1310; cETLus; CB 60950; ETL; ETL; CB 60335; S-Mark 60950; CB 62368; ETL; CB 60601-1; S-Mark; CE; China RoHS; Class I; Level VI; RoHS; Ukraine; WEEE; PSE; PSE; PSE;	
	Model No. GTM96900P9024-T3	
	Part No./Ordering No. TR9CI3750CPCIMR6BLPS	Rev C

**OUTPUTCORD AND CONNECTOR: CL1/C16021**

ACTUAL CONNECTORS, OVERMOLDS, FERRITES MAY VARY SLIGHTLY FROM THE PICTURE BELOW

CABLE TYPE	UL 2468
CABLE LENGTH&#160;(mm)	1500
CABLE TOLERANCE&#160;(mm)	±50
WIRE GAUGE (AWG)	18
CONDUCTORS	2
HANK DIMENSION (mm)	70 ± 10
CABLE / CONNECTOR OVERMOLD COLOR	GlobTek Black
FERRITE TYPE / DIMENSION	None
FERRITE # OF TURNS( <a href="#">Definition</a> )	N/A
FERRITE DIMENSION FROM STRAIN RELIEF	N/A
FERRITE DIMENSION FROM PLUG	N/A
PLUG TYPE	Female Barrel 5.5*2.1*11mm w/ Spring Clip & Locking Notch or Equal
OUTPUT CONNECTOR SEX	
OVERMOLDED	Yes
OVER MOLD ORIENTATION	Straight
CONNECTOR PIN OUT:	Center Positive (+V)
ADDITIONAL REQUIREMENTS	

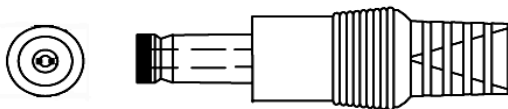

ADDITIONAL OUTPUT PLUG OPTIONS ARE AVAILABLE AT <https://www.globtek.com/connectors/>  
STANDARD PLUGS AND CONNECTORS CAN BE SEEN ONLINE AT <https://www.globtek.com/connectors/>

<b>GlobTek, Inc.</b> www.globtek.com 186 Veterans Drive, Northvale, NJ 07647 Tel. (201) 784-1000 Fax (201) 784-0111	Drawing Title: GTM96900P9024-T3, ITE / Medical Power Supply/Class 2/Household Power Supply, Efficiency Level: VI, Case Color/Style: GlobTek Black, Desktop/External, Regulated Switchmode AC-DC Power Supply AC Adaptor, Input Rating: 100-240V~, 50-60Hz, IEC 60320/C14 , Output Rating: 90W, 24V@3.75A, Output Configuration: 1500 mm, 18/2 Cond, UL 2468, Female Barrel 5.5*2.1*11mm w/ Spring Clip & Locking Notch or Equal, Ferrite: None, GlobTek Black, GT Cord # C16021, Pin Out: Center Positive (+V), Blades/Input Cord: Not Applicable, Approvals: CB 61347; RCM; LPS; CCC; Patent US9838207B2; VCCI; EAC; IP41; cETLus; UL 1310; cETLus; CB 60950; ETL; ETL; CB 60335; S-Mark 60950; CB 62368; ETL; CB 60601-1; S-Mark; CE; China RoHS; Class I; Level VI; RoHS; Ukraine; WEEE; PSE; PSE; PSE;
	Model No. GTM96900P9024-T3
	Part No./Ordering No. TR9CI3750CPCIMR6BLPS <span style="float: right;">Rev C</span>

LABEL:L-1186

LABEL P/N: Standard GT  
 MATERIAL: Flat Thermal Transfer, Imprintable, Polyester Label and/or Pad Printed and/or Molded, and/or Laser Engraved in the case  
 BACKGROUND COLOR: Black if housing is Black, White or Silver if housing is White or Gray.  
 TEXT COLOR: White or Silver if label is Black Background for Black housing. Black if label is White or Silver background and Housing is White or Gray  
 LABEL WIDTH (mm): 50.0  
 LABEL HEIGHT (mm): 110.0  
 SPECIAL BARCODE LABEL MATERIAL: No

Below is the minimum information which will appear on the label. NOTE: in the logo area additional/actual positioning of symbols and text is subjected to change as per agency updates/requirements or additional model approvals become available.  
 Regulatory certifications/label markings may be in logo area on the label or molded into the case housing outside the label area.  
 Information will be shown via label and/or pad printed and/or molded and/or laser engraved in the case. \* Date code markings at GlobTek option.

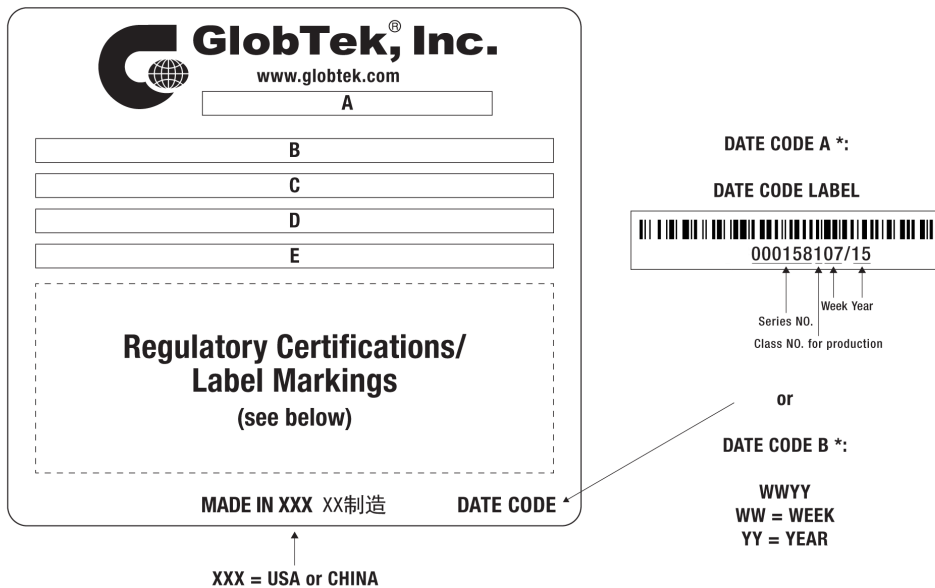

A=ITE / Medical Power Supply/Class 2/Household Power Supply  
 B=P/N: (料号) TR9CI3750CPCIMR6BLPS  
 C=Model (型号) GTM96900P9024-T3  
 D=Input (输入) 100-240V~, 50-60Hz, 1.5A  
 E=Output (输出) 24 V 3.75 A, 90.0W

AGENCY ONLINE DOCUMENTS

<http://www.globtek.info/certs/GTM96900P90VV.V/>

CE EC-Declaration for Medical

[http://globtek.force.com/models/ec\\_declaration?id=a0Oa000000MjSZHEA3](http://globtek.force.com/models/ec_declaration?id=a0Oa000000MjSZHEA3)

PROPRIETARY INFORMATION

GloTek, Inc. www.globtek.com 186 Veterans Drive, Northvale, NJ 07647 Tel. (201) 784-1000 Fax (201) 784-0111	Drawing Title: GTM96900P9024-T3, ITE / Medical Power Supply/Class 2/Household Power Supply, Efficiency Level: VI, Case Color/Style: GlobTek Black, Desktop/External, Regulated Switchmode AC-DC Power Supply AC Adaptor, Input Rating: 100-240V~, 50-60Hz, IEC 60320/C14 , Output Rating: 90W, 24V@3.75A, Output Configuration: 1500 mm, 18/2 Cond, UL 2468, Female Barrel 5.5*2.1*11mm w/ Spring Clip & Locking Notch or Equal, Ferrite: None, GlobTek Black, GT Cord # C16021, Pin Out: Center Positive (+V), Blades/Input Cord: Not Applicable, Approvals: CB 61347; RCM; LPS; CCC; Patent US9838207B2; VCCI; EAC; IP41; cETLus; UL 1310; cETLus; CB 60950; ETL; ETL; CB 60335; S-Mark 60950; CB 62368; ETL; CB 60601-1; S-Mark; CE; China RoHS; Class I; Level VI; RoHS; Ukraine; WEEE; PSE; PSE; PSE;	
	Model No. GTM96900P9024-T3	
	Part No./Ordering No. TR9CI3750CPCIMR6BLPS	Rev C

CE EC-Declaration for Industrial/Commercial/ITE [http://globtek.force.com/models/ec\\_declaration?id=a0Oa000000MjSZHEA3](http://globtek.force.com/models/ec_declaration?id=a0Oa000000MjSZHEA3)  
CE EC-Declaration for Household [http://globtek.force.com/models/ec\\_declaration?id=a0Oa000000MjSZHEA3](http://globtek.force.com/models/ec_declaration?id=a0Oa000000MjSZHEA3)  
RoHS/RoHS3 Declaration [https://www.globtek.com/pdf/rohs\\_cert/01t0c000008IEKwAAM](https://www.globtek.com/pdf/rohs_cert/01t0c000008IEKwAAM)  
REACH Declaration [https://www.globtek.com/pdf/iso\\_certificates/REACH.pdf](https://www.globtek.com/pdf/iso_certificates/REACH.pdf)  
Conflict Minerals Declaration <https://www.globtek.com/pdf/conflict-minerals.pdf>  
IPXY rating is based on 3rd party testing and customers should check suitability and test system level IPXY rating before ordering.

## Regulatory Certifications/Label Markings

LATEST PRODUCT/MODEL CERTIFICATIONS: <http://en.globtek.com/datasheet/id/a0Oa000000MjSZH>  
AGENCY ONLINE DOCUMENTS: <http://www.globtek.info/certs/GTM96900P90VV.V/>



(F2) Isolated Functional Earth for GTM96 series, Improved EMC



Center Positive (+V)

GlobTek, Inc. www.globtek.com 186 Veterans Drive, Northvale, NJ 07647 Tel. (201) 784-1000 Fax (201) 784-0111	Drawing Title: GTM96900P9024-T3. ITE / Medical Power Supply/Class 2/Household Power Supply, Efficiency Level: VI, Case Color/Style: GlobTek Black, Desktop/External, Regulated Switchmode AC-DC Power Supply AC Adaptor, Input Rating: 100-240V~, 50-60Hz, IEC 60320/C14 , Output Rating: 90W, 24V@3.75A, Output Configuration: 1500 mm, 18/2 Cond, UL 2468, Female Barrel 5.5*2.1*11mm w/ Spring Clip & Locking Notch or Equal, Ferrite: None, GlobTek Black, GT Cord # C16021, Pin Out: Center Positive (+V), Blades/Input Cord: Not Applicable, Approvals: CB 61347; RCM; LPS; CCC; Patent US9838207B2; VCCI; EAC; IP41; cETLus; UL 1310; cETLus; CB 60950; ETL; ETL; CB 60335; S-Mark 60950; CB 62368; ETL; CB 60601-1; S-Mark; CE; China RoHS; Class I; Level VI; RoHS; Ukraine; WEEE; PSE; PSE; PSE;	
	Model No. GTM96900P9024-T3	
	Part No./Ordering No. TR9CI3750CPCIMR6BLPS	Rev C

## PACKAGING

Packing Spec P/N:	Standard DT, Cellular packaging, User manual
Box Qty:	20
Gift Box Size (mm):	Egg Crate
Gift Box Color:	None
Master Carton Size (mm):	427 x 405 x 158
Master Carton Cubic Volume (m <sup>3</sup> ):	0.03
Master GW (Kg):	15.6 kg
BLADES INCLUDED:	N/A:
BLADE/CORD INSTALLED:	N/A:
USER MANUAL:	809-DESKTOPUSERMANUAL
USER MANUAL WEB LINK:	<a href="https://en.globtek.com/pdf/809-DESKTOPUSERMANUA...">https://en.globtek.com/pdf/809-DESKTOPUSERMANUA...</a>

If specific packaging is required, this section must specify all requirements and note "no exceptions". If this section does not specify packaging, it is subject to change without notice at GlobTek's discretion.

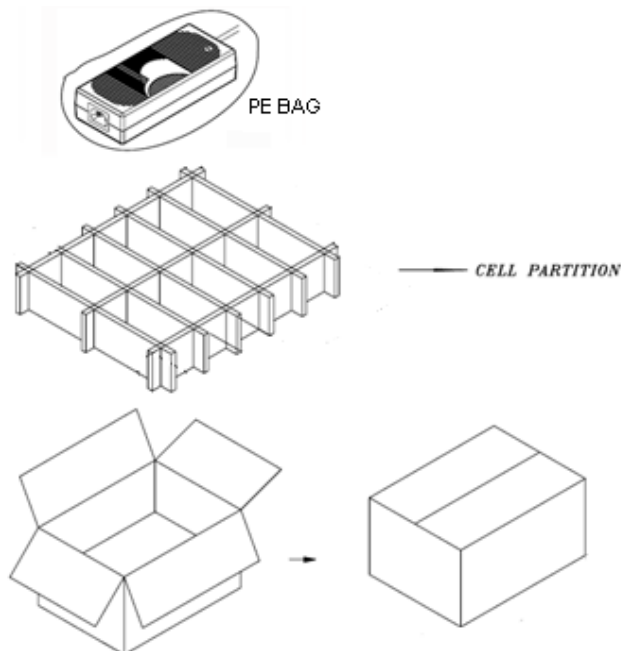

### PROPRIETARY INFORMATION

<p>GlobTek, Inc.  www.globtek.com  186 Veterans Drive,  Northvale, NJ 07647  Tel. (201) 784-1000  Fax (201) 784-0111</p>	<p>Drawing Title: GTM96900P9024-T3. ITE / Medical Power Supply/Class 2/Household Power Supply, Efficiency Level: VI, Case Color/Style: GlobTek Black, Desktop/External, Regulated Switchmode AC-DC Power Supply AC Adaptor, Input Rating: 100-240V~, 50-60Hz, IEC 60320/C14 , Output Rating: 90W, 24V@3.75A, Output Configuration: 1500 mm, 18/2 Cond, UL 2468, Female Barrel 5.5*2.1*11mm w/ Spring Clip &amp; Locking Notch or Equal, Ferrite: None, GlobTek Black, GT Cord # C16021, Pin Out: Center Positive (+V), Blades/Input Cord: Not Applicable, Approvals: CB 61347; RCM; LPS; CCC; Patent US9838207B2; VCCI; EAC; IP41; cETLus; UL 1310; cETLus; CB 60950; ETL; ETL; CB 60335; S-Mark 60950; CB 62368; ETL; CB 60601-1; S-Mark; CE; China RoHS; Class I; Level VI; RoHS; Ukraine; WEEE; PSE; PSE; PSE;</p>
	<p>Model No. GTM96900P9024-T3</p>
	<p>Part No./Ordering No. TR9CI3750CPCIMR6BLPS</p>
	<p>Rev C</p>

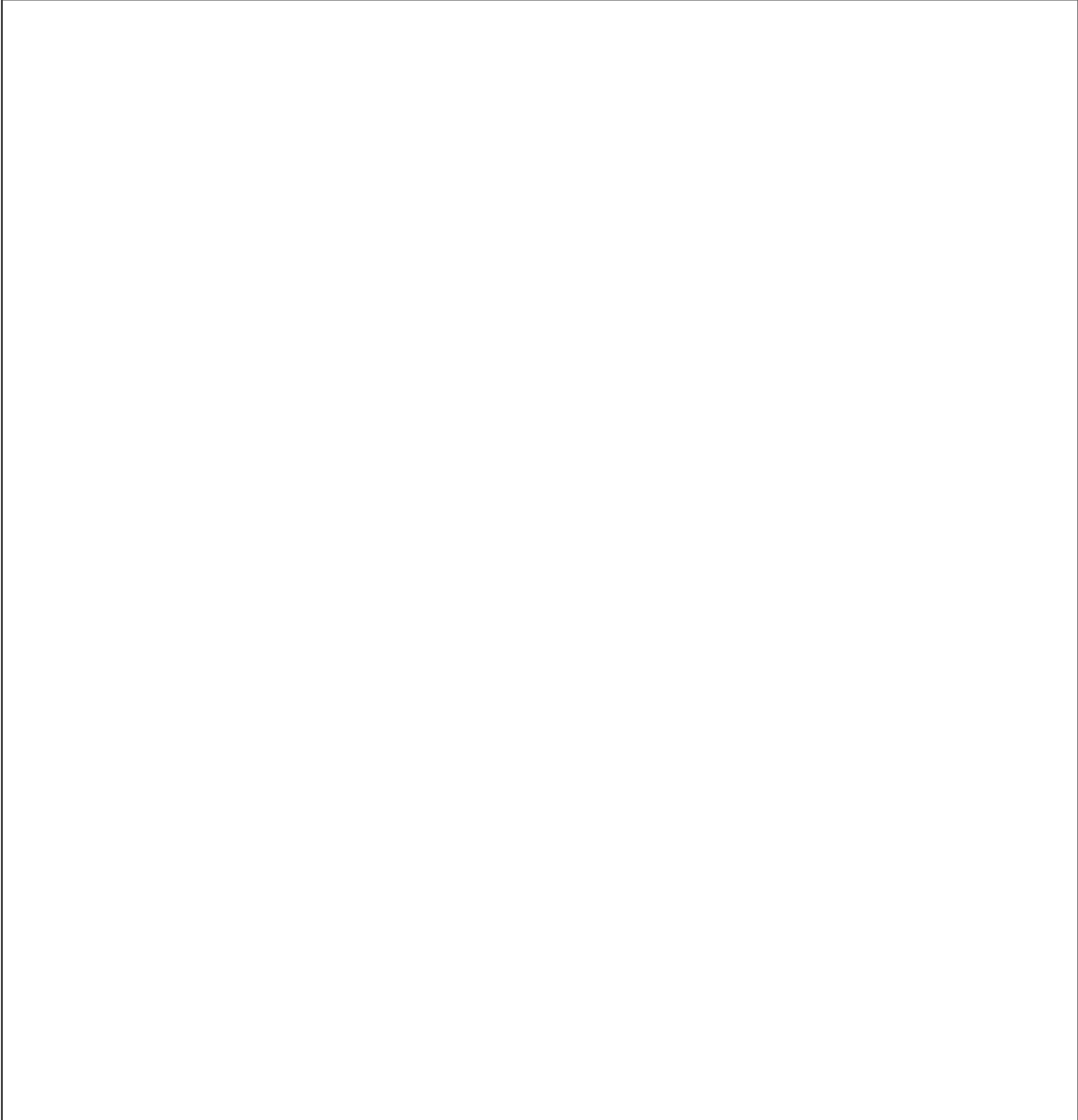

GlobTek, Inc. www.globtek.com 186 Veterans Drive, Northvale, NJ 07647 Tel. (201) 784-1000 Fax (201) 784-0111	Drawing Title: GTM96900P9024-T3, ITE / Medical Power Supply/Class 2/Household Power Supply, Efficiency Level: VI, Case Color/Style: GlobTek Black, Desktop/External, Regulated Switchmode AC-DC Power Supply AC Adaptor, Input Rating: 100-240V~, 50-60Hz, IEC 60320/C14 , Output Rating: 90W, 24V@3.75A, Output Configuration: 1500 mm, 18/2 Cond, UL 2468, Female Barrel 5.5*2.1*11mm w/ Spring Clip & Locking Notch or Equal, Ferrite: None, GlobTek Black, GT Cord # C16021, Pin Out: Center Positive (+V), Blades/Input Cord: Not Applicable, Approvals: CB 61347; RCM; LPS; CCC; Patent US9838207B2; VCCI; EAC; IP41; cETLus; UL 1310; cETLus; CB 60950; ETL; ETL; CB 60335; S-Mark 60950; CB 62368; ETL; CB 60601-1; S-Mark; CE; China RoHS; Class I; Level VI; RoHS; Ukraine; WEEE; PSE; PSE; PSE;	
	Model No. GTM96900P9024-T3	
	Part No./Ordering No. TR9CI3750CPCIMR6BLPS	Rev C

## INSTRUCTIONS TO THE OEM SYSTEMS ENGINEER

It is the responsibility of the OEM systems engineer to provide the end system user instructions and warnings for the use of this product in the end system.

If an input cord is required for this product, AC Mains voltage should be provided to the power supply by a power supply cord approved to the national standards of the country in which it will be used.

This power supply is not designed to be repaired. No serviceable parts inside. A blown internal fuse is an indication of catastrophic failure of circuit component(s). If a Failure Analysis is required for a failed power supply/battery charger, please return the damaged unit to Globtek for an accurate determination of the root cause of the failure.

EMC Compliance of the complete OEM product, including the GlobTek power supply/battery charger needs to be verified by the OEM systems engineer.

## INSTRUCTION SHEET

N/A

### PROPRIETARY INFORMATION