

<p>GlobTek, Inc. www.globtek.com 186 Veterans Drive, Northvale, NJ 07647 Tel. (201) 784-1000 Fax (201) 784-0111</p>	<p>Drawing Title: GT-86240-2412-W2E, ITE Power Supply, Efficiency Level: USA DOE Level VI / Eco-design Directive 2009/125/EC, (EU) 2019/1782, Case Color/Style: GlobTek Black, Wall Plug-in, Regulated Switchmode AC-DC Power Supply AC Adaptor, Input Rating: 100-240V~, 50-60Hz, Euro Plug Fixed , Output Rating: 24W, 12.0V@2.0A, Output Configuration: 1500 mm, 20/2 Cond, UL 2468, Female Barrel 5.5*2.1*11mm w/ Spring Clip &amp; Locking Notch or Equal, Ferrite: None, GlobTek Black, GT Cord # C8128, Pin Out: Center Positive (+V), Blades/Input Cord: Fixed Blades European 7/7 2 Conductor, Approvals: EAC; Morocco; CE; China RoHS; Double Insulation; Level VI; RoHS; Ukraine; LPS 60950; WEEE;</p>
<p>Model No. GT-86240-2412-W2E</p>	
<p>Part No./Ordering No. WR9ME2000CCP-F(R6B)</p>	<p>Rev A</p>

## REVISION HISTORY

REV	DESCRIPTION	SUB	DATE	APPROVED
A	Initial Release	fclif	05/03/2019	QA

In Addition to GlobTek Inc.'s renewed ISO9001:2015 - Quality Management System Certification, GlobTek Inc. is now certified to:

- ISO13485:2016 - Medical Devices Quality Management System Certification
- ISO14001:2015 - Environmental Management System Certification

ISO Certificates are available online at <https://www.globtek.com/iso-certificates/>

### Customer Approval of Specification:

Please approve, sign and send back to GlobTek so we can complete order processing.

A delay in receipt of this form will delay delivery schedule.

Company Name:

Customer P/N:

Quote Number:

Date:

Authorized Representative Name:

Authorized Representative Signature:

The acceptance of this specification and use of the product described in this document indicates the acceptance and binding of the customer to Globtek terms and conditions, which supersede all other agreements, terms, and conditions (<https://en.globtek.com/terms-and-conditions/>).

The purchaser of this product (Customer) agrees that it is their sole responsibility to determine suitability/fitness of the product described in this specification for their application and to take precautions for protection against any hazards attendant to the handling and use of the product.

### Footnote:

GlobTek Inc. will not be liable for the safety and performance of these power supplies if unauthorized access and repair occurs. End user should consult applicable UL, CSA or EN standards for proper installation instruction.

### Limitation of Use:

GlobTek products are intended for use with commercial, medical, and/or industrial equipment only. GlobTek product are not authorized for use as mission critical components in life support hazardous environment, nuclear or aircraft applications without prior written approval from the CEO of GlobTek Inc. Contents of this document are subject to change without prior notice.

<p>GlobTek, Inc. www.globtek.com 186 Veterans Drive, Northvale, NJ 07647 Tel. (201) 784-1000 Fax (201) 784-0111</p>	<p>Drawing Title: GT-86240-2412-W2E, ITE Power Supply, Efficiency Level: USA DOE Level VI / Eco-design Directive 2009/125/EC, (EU) 2019/1782, Case Color/Style: GlobTek Black, Wall Plug-in, Regulated Switchmode AC-DC Power Supply AC Adaptor, Input Rating: 100-240V~, 50-60Hz, Euro Plug Fixed , Output Rating: 24W, 12.0V@2.0A, Output Configuration: 1500 mm, 20/2 Cond, UL 2468, Female Barrel 5.5*2.1*11mm w/ Spring Clip &amp; Locking Notch or Equal, Ferrite: None, GlobTek Black, GT Cord # C8128, Pin Out: Center Positive (+V), Blades/Input Cord: Fixed Blades European 7/7 2 Conductor, Approvals: EAC; Morocco; CE; China RoHS; Double Insulation; Level VI; RoHS; Ukraine; LPS 60950; WEEE;</p> <p>Model No. GT-86240-2412-W2E</p> <p>Part No./Ordering No. WR9ME2000CCP-F(R6B)</p>	<p>Rev A</p>
---	---	--------------

## POWER SUPPLY INFORMATION

TYPE:	Wall Plug-in
TECHNOLOGY:	Regulated Switchmode AC-DC Power Supply AC Adaptor
CASE COLOR:	GlobTek Black
NAMEPLATE RATED INPUT:	100-240V~, 50-60Hz, 1A
INPUT CONFIG:	Euro Plug Fixed
WATTS:	24.0
VOLTS OUT:	12.0
CURRENT OUT (Amps):	2.0
INGRESS PROTECTION:	IPX0
GROUNDING CONFIGURATION:	(F1) Class II / Double Insulated
EFFICIENCY LEVEL:	
OUTPUT CONFIGURATION:	1500 mm, 20/2 Cond, UL 2468, Female Barrel 5.5*2.1*11mm w/ Spring Clip & Locking Notch or Equal, Ferrite: None, GlobTek Black, GT Cord # C8128
CONNECTOR PIN OUT:	Center Positive (+V)
LABEL SPECS:	Standard GT,L-1186
SPECIAL BARCODE LABEL	
MATERIAL:	
PACK SPEC:	
USER MANUAL:	

### PROPRIETARY INFORMATION

PROPRIETARY OF GLOBTEK, INC. ANY REPRODUCTION, DISCLOSURE OR USE OF THIS DRAWING, IN WHOLE OR IN PART, IS HEREBY PROHIBITED EXCEPT AS SPECIFIED IN WRITING BY GLOBTEK, INC. © GlobTek, Inc. 2018 - 2020

<p>GlobTek, Inc.  www.globtek.com  186 Veterans Drive,  Northvale, NJ 07647  Tel. (201) 784-1000  Fax (201) 784-0111</p>	<p>Drawing Title: GT-86240-2412-W2E, ITE Power Supply, Efficiency Level: USA DOE Level VI / Eco-design Directive 2009/125/EC, (EU) 2019/1782, Case Color/Style: GlobTek Black, Wall Plug-in, Regulated Switchmode AC-DC Power Supply AC Adaptor, Input Rating: 100-240V~, 50-60Hz, Euro Plug Fixed , Output Rating: 24W, 12.0V@2.0A, Output Configuration: 1500 mm, 20/2 Cond, UL 2468, Female Barrel 5.5*2.1*11mm w/ Spring Clip &amp; Locking Notch or Equal, Ferrite: None, GlobTek Black, GT Cord # C8128, Pin Out: Center Positive (+V), Blades/Input Cord: Fixed Blades European 7/7 2 Conductor, Approvals: EAC; Morocco; CE; China RoHS; Double Insulation; Level VI; RoHS; Ukraine; LPS 60950; WEEE;</p>
	<p>Model No. GT-86240-2412-W2E</p>
	<p>Part No./Ordering No. WR9ME2000CCP-F(R6B) <span style="float: right;">Rev A</span></p>

Notes/Modifications/Customizations (notes in this section supersede the values shown in the standard spec):  
DIMENSIONS ARE IN MM UNLESS SPECIFIED OTHERWISE.

GlobTek, Inc. www.globtek.com 186 Veterans Drive, Northvale, NJ 07647 Tel. (201) 784-1000 Fax (201) 784-0111	Drawing Title: GT-86240-2412-W2E, ITE Power Supply, Efficiency Level: USA DOE Level VI / Eco-design Directive 2009/125/EC, (EU) 2019/1782, Case Color/Style: GlobTek Black, Wall Plug-in, Regulated Switchmode AC-DC Power Supply AC Adaptor, Input Rating: 100-240V~, 50-60Hz, Euro Plug Fixed , Output Rating: 24W, 12.0V@2.0A, Output Configuration: 1500 mm, 20/2 Cond, UL 2468, Female Barrel 5.5*2.1*11mm w/ Spring Clip & Locking Notch or Equal, Ferrite: None, GlobTek Black, GT Cord # C8128, Pin Out: Center Positive (+V), Blades/Input Cord: Fixed Blades European 7/7 2 Conductor, Approvals: EAC; Morocco; CE; China RoHS; Double Insulation; Level VI; RoHS; Ukraine; LPS 60950; WEEE;	
	Model No. GT-86240-2412-W2E	
Part No./Ordering No. WR9ME2000CCP-F(R6B)		Rev A

## ELECTRICAL SPECIFICATIONS

### A) ELECTRICAL SPECIFICATIONS:

01. Input Voltage: Specified 90-264 Vac, Nameplate rated: 100-240Vac
02. Input Frequency: Specified 47-63 Hz, Nameplate rated 50-60Hz
03. Output Regulation: +/- 5%
04. Ripple and Noise (Vp-p): 300 mVp-p maximum, At 20 MHz, and output parallel with 0.1uF & 47uF capacitors to ground. Temperature at 25 °C, and nominal input voltage
05. Efficiency: Compliant with Efficiency Level VI and CoC Tier 2 standards
07. No Load Standby Power: <0.075W @ 230Vac
08. Turn-ON Delay: 3 Seconds maximum at nominal input voltage
09. Rise Time: 100mS maximum at nominal input voltage

### B) PROTECTION

01. Over-Voltage: 20VDC maximum
02. Over current protection: 4A maximum with auto-recovery function
03. Short Circuit: Short circuit protection is to be included in the construction of the adaptor. The adaptor is designed to withstand continuous current of a short circuit on the output. The adaptor will be short circuit tolerant for an indefinite period.

### C) SAFETY

01. Dielectric Withstand Voltage: 4242Vdc from primary to secondary
02. Leakage current: 0.25mA maximum, at nominal AC input voltage and frequency
03. ESD: 8KV(air) / 4KV (contact)

### D) OTHER:

01. MTBF: 200,000 Hours @ 25°C ambient temperature
02. Operating Temperature: 0°C to 40°C ambient temperature
03. Humidity: 0% to 90% relative humidity
04. Storage Temperature: -10°C to 80°C
05. Cooling: natural convection cooling
06. ROHS 2: Complies with EU 2011/65/EU and China SJ/T 11363-2006

### E) ENCLOSURE

01. Housing: High impact plastic, 94V0 polycarbonate, non-vented
02. Markings: Label and/or Pad Printed and/or Molded in the case

TO ADDRESS SYSTEM-LEVEL EMI CONCERNS, FERRITE CHOKES/BEADS MAY BE ADDED/REVISED UPON REQUEST. A SAMPLE KIT OF GLOBTEK'S STANDARD FERRITES IS AVAILABLE UNDER GLOBTEK P/N: EMI-MITIGATION-KIT1

FOR ADDITIONAL INFORMATION, PLEASE READ OUR WHITE PAPER AT:

<https://en.globtek.com/technical-articles/ferrite-kit-radiated-emi-suppression-kit-for-globtek-power-supplies-cable-assemblies>

INGRESS PROTECTION: IPX0

#### PROPRIETARY INFORMATION

PROPRIETARY OF GLOBTEK, INC. ANY REPRODUCTION, DISCLOSURE OR USE OF THIS DRAWING, IN WHOLE OR IN PART, IS HEREBY PROHIBITED EXCEPT AS SPECIFIED IN

WRITING BY GLOBTEK, INC. © GlobTek, Inc. 2018 - 2020

quest /07/02/2020 7:05:34 PM CLONED FROM WR9ME2000LCP-F(R6B)

<p>GlobTek, Inc.  www.globtek.com  186 Veterans Drive,  Northvale, NJ 07647  Tel. (201) 784-1000  Fax (201) 784-0111</p>	<p>Drawing Title: GT-86240-2412-W2E, ITE Power Supply, Efficiency Level: USA DOE Level VI / Eco-design Directive 2009/125/EC, (EU) 2019/1782, Case Color/Style: GlobTek Black, Wall Plug-in, Regulated Switchmode AC-DC Power Supply AC Adaptor, Input Rating: 100-240V~, 50-60Hz, Euro Plug Fixed , Output Rating: 24W, 12.0V@2.0A, Output Configuration: 1500 mm, 20/2 Cond, UL 2468, Female Barrel 5.5*2.1*11mm w/ Spring Clip &amp; Locking Notch or Equal, Ferrite: None, GlobTek Black, GT Cord # C8128, Pin Out: Center Positive (+V), Blades/Input Cord: Fixed Blades European 7/7 2 Conductor, Approvals: EAC; Morocco; CE; China RoHS; Double Insulation; Level VI; RoHS; Ukraine; LPS 60950; WEEE;</p> <p>Model No. GT-86240-2412-W2E</p> <p>Part No./Ordering No. WR9ME2000CCP-F(R6B)</p>	<p>Rev A</p>
--	---	--------------

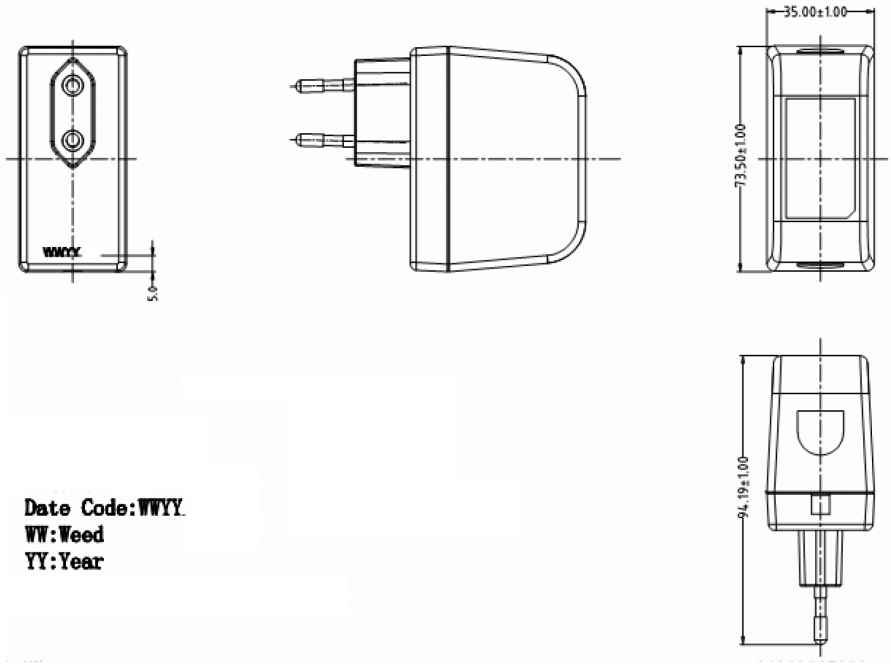

<p>GlobTek, Inc.  www.globtek.com  186 Veterans Drive,  Northvale, NJ 07647  Tel. (201) 784-1000  Fax (201) 784-0111</p>	<p>Drawing Title: GT-86240-2412-W2E, ITE Power Supply, Efficiency Level: USA DOE Level VI / Eco-design Directive 2009/125/EC, (EU) 2019/1782, Case Color/Style: GlobTek Black, Wall Plug-in, Regulated Switchmode AC-DC Power Supply AC Adaptor, Input Rating: 100-240V~, 50-60Hz, Euro Plug Fixed , Output Rating: 24W, 12.0V@2.0A, Output Configuration: 1500 mm, 20/2 Cond, UL 2468, Female Barrel 5.5*2.1*11mm w/ Spring Clip &amp; Locking Notch or Equal, Ferrite: None, GlobTek Black, GT Cord # C8128, Pin Out: Center Positive (+V), Blades/Input Cord: Fixed Blades European 7/7 2 Conductor, Approvals: EAC; Morocco; CE; China RoHS; Double Insulation; Level VI; RoHS; Ukraine; LPS 60950; WEEE;</p> <p>Model No. GT-86240-2412-W2E</p> <p>Part No./Ordering No. WR9ME2000CCP-F(R6B)</p>	<p>Rev A</p>
--	---	--------------

DERATING CURVE

**Typical External  
Power Supply Derating Curve**  
(For Efficiency Level V and Efficiency Level VI Products)

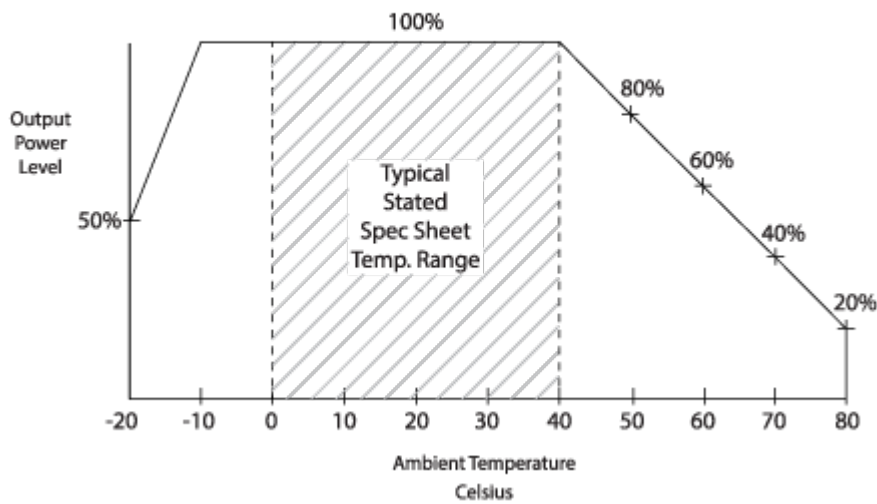

<p>GlobTek, Inc.  www.globtek.com  186 Veterans Drive,  Northvale, NJ 07647  Tel. (201) 784-1000  Fax (201) 784-0111</p>	<p>Drawing Title: GT-86240-2412-W2E, ITE Power Supply, Efficiency Level: USA DOE Level VI / Eco-design Directive 2009/125/EC, (EU) 2019/1782, Case Color/Style: GlobTek Black, Wall Plug-in, Regulated Switchmode AC-DC Power Supply AC Adaptor, Input Rating: 100-240V~, 50-60Hz, Euro Plug Fixed , Output Rating: 24W, 12.0V@2.0A, Output Configuration: 1500 mm, 20/2 Cond, UL 2468, Female Barrel 5.5*2.1*11mm w/ Spring Clip &amp; Locking Notch or Equal, Ferrite: None, GlobTek Black, GT Cord # C8128, Pin Out: Center Positive (+V), Blades/Input Cord: Fixed Blades European 7/7 2 Conductor, Approvals: EAC; Morocco; CE; China RoHS; Double Insulation; Level VI; RoHS; Ukraine; LPS 60950; WEEE;</p> <p>Model No. GT-86240-2412-W2E</p> <p>Part No./Ordering No. WR9ME2000CCP-F(R6B)</p>	<p>Rev A</p>
--	---	--------------

**INPUT CONFIGURATION**

(F1) Class II / Double Insulated

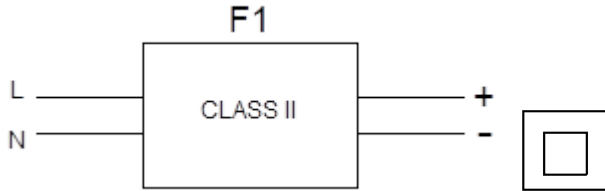

[Alternate grounding configurations](#) available upon request.

NEMA 1-15P, North America Blades, Class II 2 Conductors

All NEMA 1 devices are two-wire non-grounding devices (hot-neutral) rated for 125 V maximum. NEMA 1-15P plugs have two parallel flat blades, 0.25 inches (6.35 mm) wide, 0.06 inches (1.524 mm) thick, 0.625-0.718 inches (15.875–18.256 mm) long, and spaced 0.5 inches (12.7 mm) apart.

GlobTek, Inc. www.globtek.com 186 Veterans Drive, Northvale, NJ 07647 Tel. (201) 784-1000 Fax (201) 784-0111	Drawing Title: GT-86240-2412-W2E, ITE Power Supply, Efficiency Level: USA DOE Level VI / Eco-design Directive 2009/125/EC, (EU) 2019/1782, Case Color/Style: GlobTek Black, Wall Plug-in, Regulated Switchmode AC-DC Power Supply AC Adaptor, Input Rating: 100-240V~, 50-60Hz, Euro Plug Fixed , Output Rating: 24W, 12.0V@2.0A, Output Configuration: 1500 mm, 20/2 Cond, UL 2468, Female Barrel 5.5*2.1*11mm w/ Spring Clip & Locking Notch or Equal, Ferrite: None, GlobTek Black, GT Cord # C8128, Pin Out: Center Positive (+V), Blades/Input Cord: Fixed Blades European 7/7 2 Conductor, Approvals: EAC; Morocco; CE; China RoHS; Double Insulation; Level VI; RoHS; Ukraine; LPS 60950; WEEE;	
	Model No. GT-86240-2412-W2E	
Part No./Ordering No. WR9ME2000CCP-F(R6B)		Rev A

OUTPUT CORD AND CONNECTOR: CL1/C8128

ACTUAL CONNECTORS, OVERMOLDS, FERRITES MAY VARY SLIGHTLY FROM THE PICTURE BELOW

CABLE TYPE	UL 2468
CABLE LENGTH (mm)	1500
CABLE TOLERANCE (mm)	+/-50
WIRE GAUGE (AWG)	20
CONDUCTORS	2
HANK DIMENSION (mm)	70 ± 10
CABLE / CONNECTOR OVERMOLD COLOR	GlobTek Black
FERRITE TYPE / DIMENSION	None
FERRITE # OF TURNS <a href="#">(Definition)</a>	N/A
FERRITE DIMENSION FROM STRAIN RELIEF	N/A
FERRITE DIMENSION FROM PLUG	N/A
PLUG TYPE	Female Barrel 5.5*2.1*11mm w/ Spring Clip & Locking Notch or Equal
OUTPUT CONNECTOR SEX	
OVERMOLDED	
OVER MOLD ORIENTATION	Straight
CONNECTOR PIN OUT:	Center Positive (+V)
ADDITIONAL REQUIREMENTS	

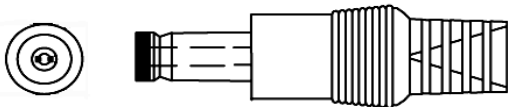

ADDITIONAL OUTPUT PLUG OPTIONS ARE AVAILABLE AT <https://www.globtek.com/connectors/>  
STANDARD PLUGS AND CONNECTORS CAN BE SEEN ONLINE AT <https://www.globtek.com/connectors/>



<p>GlobTek, Inc.  www.globtek.com  186 Veterans Drive,  Northvale, NJ 07647  Tel. (201) 784-1000  Fax (201) 784-0111</p>	<p>Drawing Title: GT-86240-2412-W2E, ITE Power Supply, Efficiency Level: USA DOE Level VI / Eco-design Directive 2009/125/EC, (EU) 2019/1782, Case Color/Style: GlobTek Black, Wall Plug-in, Regulated Switchmode AC-DC Power Supply AC Adaptor, Input Rating: 100-240V~, 50-60Hz, Euro Plug Fixed , Output Rating: 24W, 12.0V@2.0A, Output Configuration: 1500 mm, 20/2 Cond, UL 2468, Female Barrel 5.5*2.1*11mm w/ Spring Clip &amp; Locking Notch or Equal, Ferrite: None, GlobTek Black, GT Cord # C8128, Pin Out: Center Positive (+V), Blades/Input Cord: Fixed Blades European 7/7 2 Conductor, Approvals: EAC; Morocco; CE; China RoHS; Double Insulation; Level VI; RoHS; Ukraine; LPS 60950; WEEE;</p>
	<p>Model No. GT-86240-2412-W2E</p>
	<p>Part No./Ordering No. WR9ME2000CCP-F(R6B) <span style="float: right;">Rev A</span></p>

## OUTPUT CONNECTOR HOOK UP

TO ADDRESS SYSTEM-LEVEL EMI CONCERNS, FERRITE CHOKES/BEADS MAY BE ADDED/REVISED UPON REQUEST. A SAMPLE KIT OF GLOBTEK'S STANDARD FERRITES IS AVAILABLE UNDER GLOBTEK P/N: EMI-MITIGATION-KIT1

FOR ADDITIONAL INFORMATION, PLEASE READ OUR WHITE PAPER AT:

<https://en.globtek.com/technical-articles/ferrite-kit-radiated-emi-suppression-kit-for-globtek-power-supplies-cable-assemblies>

<p>GlobTek, Inc.  www.globtek.com  186 Veterans Drive,  Northvale, NJ 07647  Tel. (201) 784-1000  Fax (201) 784-0111</p>	<p>Drawing Title: GT-86240-2412-W2E, ITE Power Supply, Efficiency Level: USA DOE Level VI / Eco-design Directive 2009/125/EC, (EU) 2019/1782, Case Color/Style: GlobTek Black, Wall Plug-in, Regulated Switchmode AC-DC Power Supply AC Adaptor, Input Rating: 100-240V~, 50-60Hz, Euro Plug Fixed , Output Rating: 24W, 12.0V@2.0A, Output Configuration: 1500 mm, 20/2 Cond, UL 2468, Female Barrel 5.5*2.1*11mm w/ Spring Clip &amp; Locking Notch or Equal, Ferrite: None, GlobTek Black, GT Cord # C8128, Pin Out: Center Positive (+V), Blades/Input Cord: Fixed Blades European 7/7 2 Conductor, Approvals: EAC; Morocco; CE; China RoHS; Double Insulation; Level VI; RoHS; Ukraine; LPS 60950; WEEE;</p> <p>Model No. GT-86240-2412-W2E</p> <p>Part No./Ordering No. WR9ME2000CCP-F(R6B) <span style="float: right;">Rev A</span></p>
--	--

<p>LABEL:L-1186</p>	
<p>LABEL P/N:</p>	<p>Standard GT</p>
<p>MATERIAL:</p>	<p>Flat Thermal Transfer, Imprintable, Polyester Label and/or Pad Printed and/or Molded, and/or Laser Engraved in the case</p>
<p>BACKGROUND COLOR:</p>	<p>Black if housing is Black, White or Silver if housing is White or Gray.</p>
<p>TEXT COLOR:</p>	<p>White or Silver if label is Black Background for Black housing. Black if label is White or Silver background and Housing is White or Gray.</p>
<p>LABEL WIDTH (mm):</p>	<p>39.7</p>
<p>LABEL HEIGHT (mm):</p>	<p>16.2</p>
<p>SPECIAL BARCODE LABEL MATERIAL:</p>	

<p>GlobTek, Inc. www.globtek.com 186 Veterans Drive, Northvale, NJ 07647 Tel. (201) 784-1000 Fax (201) 784-0111</p>	<p>Drawing Title: GT-86240-2412-W2E, ITE Power Supply, Efficiency Level: USA DOE Level VI / Eco-design Directive 2009/125/EC, (EU) 2019/1782, Case Color/Style: GlobTek Black, Wall Plug-in, Regulated Switchmode AC-DC Power Supply AC Adaptor, Input Rating: 100-240V~, 50-60Hz, Euro Plug Fixed , Output Rating: 24W, 12.0V@2.0A, Output Configuration: 1500 mm, 20/2 Cond, UL 2468, Female Barrel 5.5*2.1*11mm w/ Spring Clip &amp; Locking Notch or Equal, Ferrite: None, GlobTek Black, GT Cord # C8128, Pin Out: Center Positive (+V), Blades/Input Cord: Fixed Blades European 7/7 2 Conductor, Approvals: EAC; Morocco; CE; China RoHS; Double Insulation; Level VI; RoHS; Ukraine; LPS 60950; WEEE;</p> <p>Model No. GT-86240-2412-W2E</p> <p>Part No./Ordering No. WR9ME2000CCP-F(R6B)</p>	<p>Rev A</p>
---	---	--------------

Below is the minimum information which will appear on the label. NOTE: in the logo area additional/actual positioning of symbols and text is subjected to change as per agency updates/requirements or additional model approvals become available.  
Regulatory certifications/label markings may be in logo area on the label or molded into the case housing outside the label area.  
Information will be shown via label and/or pad printed and/or molded and/or laser engraved in the case. \* Date code markings at GlobTek option

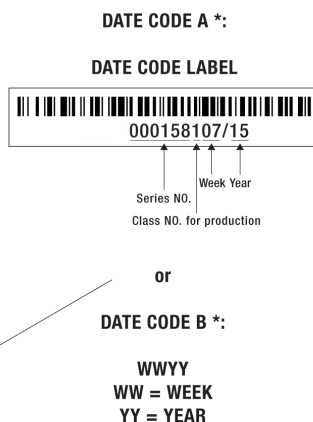

A=ITE Power Supply  
B=P/N: (料号) WR9ME2000CCP-F(R6B)  
C=Model (型号) GT-86240-2412-W2E  
D=Input (输入)100-240V~, 50-60Hz, 1A  
E=Output (输出)12.0 V  2.0 A, 24.0W

AGENCY ONLINE DOCUMENTS	<a href="http://www.globtek.info/certs/GT-86240(-W2)/">http://www.globtek.info/certs/GT-86240(-W2)/</a>
CE EC-Declaration for Medical	<a href="#">Contact GlobTek for more information</a>
CE EC-Declaration for Industrial/Commercial/ITE	<a href="http://globtek.force.com/models/ec_declaration_product?id=01t0c000008pxHI&amp;i=5">http://globtek.force.com/models/ec_declaration_product?id=01t0c000008pxHI&amp;i=5</a>
CE EC-Declaration for Household	<a href="#">Contact GlobTek for more information</a>
Morocco SDoC Declaration	<a href="https://globtek.secure.force.com/models/Morocco_SDoC_Declaration?id=a0Oa000000FjGbDEAV">https://globtek.secure.force.com/models/Morocco_SDoC_Declaration?id=a0Oa000000FjGbDEAV</a>
RoHS/RoHS3 Declaration	<a href="https://www.globtek.com/pdf/rohs_cert/01t0c000008pxHIAAI">https://www.globtek.com/pdf/rohs_cert/01t0c000008pxHIAAI</a>
REACH Declaration	<a href="https://www.globtek.com/pdf/iso_certificates/REACH.pdf">https://www.globtek.com/pdf/iso_certificates/REACH.pdf</a>
Conflict Minerals Declaration	<a href="https://www.globtek.com/pdf/conflict-minerals.pdf">https://www.globtek.com/pdf/conflict-minerals.pdf</a>

IPXY rating is based on 3rd party testing and customers should check suitability and test system level IPXY rating before ordering.

<p>GlobTek, Inc.  www.globtek.com  186 Veterans Drive,  Northvale, NJ 07647  Tel. (201) 784-1000  Fax (201) 784-0111</p>	<p>Drawing Title: GT-86240-2412-W2E, ITE Power Supply, Efficiency Level: USA DOE Level VI / Eco-design Directive 2009/125/EC, (EU) 2019/1782, Case Color/Style: GlobTek Black, Wall Plug-in, Regulated Switchmode AC-DC Power Supply AC Adaptor, Input Rating: 100-240V~, 50-60Hz, Euro Plug Fixed , Output Rating: 24W, 12.0V@2.0A, Output Configuration: 1500 mm, 20/2 Cond, UL 2468, Female Barrel 5.5*2.1*11mm w/ Spring Clip &amp; Locking Notch or Equal, Ferrite: None, GlobTek Black, GT Cord # C8128, Pin Out: Center Positive (+V), Blades/Input Cord: Fixed Blades European 7/7 2 Conductor, Approvals: EAC; Morocco; CE; China RoHS; Double Insulation; Level VI; RoHS; Ukraine; LPS 60950; WEEE;</p> <p>Model No. GT-86240-2412-W2E</p> <p>Part No./Ordering No. WR9ME2000CCP-F(R6B)</p>	<p>Rev A</p>
--	---	--------------

## Regulatory Certifications/Label Markings

LATEST PRODUCT/MODEL CERTIFICATIONS: <http://en.globtek.com/datasheet/id/a00a000000FjGbD>

AGENCY ONLINE DOCUMENTS: [http://www.globtek.info/certs/GT-86240\(-W2\)/](http://www.globtek.info/certs/GT-86240(-W2)/)



(F1) Class II / Double Insulated

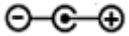

Center Positive (+V)

GlobTek, Inc. www.globtek.com 186 Veterans Drive, Northvale, NJ 07647 Tel. (201) 784-1000 Fax (201) 784-0111	Drawing Title: GT-86240-2412-W2E, ITE Power Supply, Efficiency Level: USA DOE Level VI / Eco-design Directive 2009/125/EC, (EU) 2019/1782, Case Color/Style: GlobTek Black, Wall Plug-in, Regulated Switchmode AC-DC Power Supply AC Adaptor, Input Rating: 100-240V~, 50-60Hz, Euro Plug Fixed , Output Rating: 24W, 12.0V@2.0A, Output Configuration: 1500 mm, 20/2 Cond, UL 2468, Female Barrel 5.5*2.1*11mm w/ Spring Clip & Locking Notch or Equal, Ferrite: None, GlobTek Black, GT Cord # C8128, Pin Out: Center Positive (+V), Blades/Input Cord: Fixed Blades European 7/7 2 Conductor, Approvals: EAC; Morocco; CE; China RoHS; Double Insulation; Level VI; RoHS; Ukraine; LPS 60950; WEEE;	
	Model No. GT-86240-2412-W2E	Part No./Ordering No. WR9ME2000CCP-F(R6B)
		Rev A

## PACKAGING

Packing Spec P/N:

Box Qty:	80
Gift Box Size (mm):	90.5 x 73 x 53
Gift Box Color:	White
Master Carton Size (mm):	388 x 380 x 245
Master Carton Cubic Volume (m³):	0.04
Master GW (Kg):	15.2 kg
BLADES INCLUDED:	:
BLADE/CORD INSTALLED:	:
USER MANUAL*:	
USER MANUAL WEB LINK:	

\* This specification sheet is considered the user manual for all applications. It is expected that the buyer of this product will use it to formulate their own user manual for their end product and a user manual specifically for the power adapter is not usually required. If a user manual is not specifically listed above then none will be provided with this unit.

GlobTek, Inc. www.globtek.com 186 Veterans Drive, Northvale, NJ 07647 Tel. (201) 784-1000 Fax (201) 784-0111	Drawing Title: GT-86240-2412-W2E, ITE Power Supply, Efficiency Level: USA DOE Level VI / Eco-design Directive 2009/125/EC, (EU) 2019/1782, Case Color/Style: GlobTek Black, Wall Plug-in, Regulated Switchmode AC-DC Power Supply AC Adaptor, Input Rating: 100-240V~, 50-60Hz, Euro Plug Fixed , Output Rating: 24W, 12.0V@2.0A, Output Configuration: 1500 mm, 20/2 Cond, UL 2468, Female Barrel 5.5*2.1*11mm w/ Spring Clip & Locking Notch or Equal, Ferrite: None, GlobTek Black, GT Cord # C8128, Pin Out: Center Positive (+V), Blades/Input Cord: Fixed Blades European 7/7 2 Conductor, Approvals: EAC; Morocco; CE; China RoHS; Double Insulation; Level VI; RoHS; Ukraine; LPS 60950; WEEE;	
	Model No. GT-86240-2412-W2E	
	Part No./Ordering No. WR9ME2000CCP-F(R6B)	Rev A

## INSTRUCTIONS TO THE OEM SYSTEMS ENGINEER

It is the responsibility of the OEM systems engineer to provide the end system user instructions and warnings for the use of this product in the end system.

If an input cord is required for this product, AC Mains voltage should be provided to the power supply by a power supply cord approved to the national standards of the country in which it will be used.

This power supply is not designed to be repaired. No serviceable parts inside. A blown internal fuse is an indication of catastrophic failure of circuit component(s). If a Failure Analysis is required for a failed power supply/battery charger, please return the damaged unit to Globtek for an accurate determination of the root cause of the failure.

EMC Compliance of the complete OEM product, including the GlobTek power supply/battery charger needs to be verified by the OEM systems engineer.

## INSTRUCTION SHEET

N/A