

<p>GlobTek, Inc. www.globtek.com 186 Veterans Drive, Northvale, NJ 07647 Tel. (201) 784-1000 Fax (201) 784-0111</p>	<p>Drawing Title: GT-86181-1810 -W2E, ICT/ITE Power Supply, Efficiency Level: USA DOE Level VI / Eco-design Directive 2009/125/EC, (EU) 2019/1782, Case Color/Style: GlobTek Black, Wall Plug-in, Regulated Switchmode AC-DC Power Supply AC Adaptor, Input Rating: 100-240V~, 50/60Hz, Euro Plug Fixed , Output Rating: 18W, 10.0V@1.8A, Output Configuration: 1500 mm, 20/2 Cond, UL 2468, Female Barrel 5.5 * 2.5 * 11mm with internal Spring Clip and Locking Notch or Equal, Ferrite: None, GlobTek Black, GT Cord # C14357, Pin Out: Center Positive (+V), Blades/Input Cord: (Order Separately), Approvals: CE; EAC; China RoHS; Double Insulation; Level VI; CB 62368; RoHS; Ukraine: WEEE; LPS 62368; Morocco;</p>
	<p>Model No. GT-86181-1810 -W2E Part No./Ordering No. WR9MU1800LCP-F(R6B) <span style="float: right;">Rev A</span></p>

## REVISION HISTORY

REV	DESCRIPTION	SUB	DATE	APPROVED
A	Initial Release		05/03/2019	QA

In Addition to GlobTek Inc.'s renewed ISO9001:2015 - Quality Management System Certification, GlobTek Inc. is now certified to:

- ISO13485:2016 - Medical Devices Quality Management System Certification
- ISO14001:2015 - Environmental Management System Certification

ISO Certificates are available online at <https://www.globtek.com/iso-certificates/>

### Customer Approval of Specification:

Please approve, sign and send back to GlobTek so we can complete order processing.

A delay in receipt of this form will delay delivery schedule.

Company Name:

Customer P/N:

Quote Number:

Date:

Authorized Representative Name:

Authorized Representative Signature:

The acceptance of this specification and use of the product described in this document indicates the acceptance and binding of the customer to Globtek terms and conditions, which supersede all other agreements, terms, and conditions (<https://en.globtek.com/terms-and-conditions/>).

The purchaser of this product (Customer) agrees that it is their sole responsibility to determine suitability/fitness of the product described in this specification for their application and to take precautions for protection against any hazards attendant to the handling and use of the product.

### Footnote:

GlobTek Inc. will not be liable for the safety and performance of these power supplies if unauthorized access and repair occurs. End user should consult applicable UL, CSA or EN standards for proper installation instruction.

### Limitation of Use:

GlobTek products are intended for use with commercial, medical, and/or industrial equipment only. GlobTek product are not authorized for use as mission critical components in life support hazardous environment, nuclear or aircraft applications without prior written approval from the CEO of GlobTek Inc. Contents of this document are subject to change without prior notice.

<b>GlobTek, Inc.</b> <b>www.globtek.com</b> <b>186 Veterans Drive,</b> <b>Northvale, NJ 07647</b> <b>Tel. (201) 784-1000</b> <b>Fax (201) 784-0111</b>	Drawing Title: GT-86181-1810 -W2E, ICT/ITE Power Supply, Efficiency Level: USA DOE Level VI / Eco-design Directive 2009/125/EC, (EU) 2019/1782, Case Color/Style: GlobTek Black, Wall Plug-in, Regulated Switchmode AC-DC Power Supply AC Adaptor, Input Rating: 100-240V~, 50/60Hz, Euro Plug Fixed , Output Rating: 18W, 10.0V@1.8A, Output Configuration: 1500 mm, 20/2 Cond, UL 2468, Female Barrel 5.5 * 2.5 * 11mm with internal Spring Clip and Locking Notch or Equal, Ferrite: None, GlobTek Black, GT Cord # C14357, Pin Out: Center Positive (+V), Blades/Input Cord: (Order Separately), Approvals: CE; EAC; China RoHS; Double Insulation; Level VI; CB 62368; RoHS; Ukraine: WEEE; LPS 62368; Morocco;	
	Model No. GT-86181-1810 -W2E	Part No./Ordering No. WR9MU1800LCP-F(R6B)

## POWER SUPPLY INFORMATION

TYPE:	Wall Plug-in
TECHNOLOGY:	Regulated Switchmode AC-DC Power Supply AC Adaptor
CASE COLOR:	GlobTek Black
NAMEPLATE RATED INPUT:	100-240V~, 50/60Hz, 0.6 A
INPUT CONFIG:	Euro Plug Fixed
WATTS:	18.0
VOLTS OUT:	10.0
CURRENT OUT (Amps):	1.8
BLADE/CORD INCLUDED:	None (Order Separately)
BLADE/CORD INSTALLED:	None :(Order Separately)
INGRESS PROTECTION:	Indoor Use
GROUNDING CONFIGURATION:	(F1) Class II / Double Insulated
EFFICIENCY LEVEL:	USA DOE Level VI / Eco-design Directive 2009/125/EC, (EU) 2019/1782
OUTPUT CONFIGURATION:	1500 mm, 20/2 Cond, UL 2468, Female Barrel 5.5 * 2.5 * 11mm with internal Spring Clip and Locking Notch or Equal, Ferrite: None, GlobTek Black, GT Cord # C14357
OVERMOLDED:	Yes
CONNECTOR PIN OUT:	Center Positive (+V)
LABEL SPECS:	Standard GT,L-1186
SPECIAL BARCODE LABEL MATERIAL:	No
PACK SPEC:	Standard WPI, Cellular packaging
USER MANUAL:	

### PROPRIETARY INFORMATION

PROPRIETARY OF GLOBTEK, INC. ANY REPRODUCTION, DISCLOSURE OR USE OF THIS DRAWING, IN WHOLE OR IN PART, IS HEREBY PROHIBITED EXCEPT AS SPECIFIED IN WRITING BY GLOBTEK, INC. © GlobTek, Inc. 2019 - 2021

<p>GlobTek, Inc.  www.globtek.com  186 Veterans Drive,  Northvale, NJ 07647  Tel. (201) 784-1000  Fax (201) 784-0111</p>	<p>Drawing Title: GT-86181-1810 -W2E, ICT/ITE Power Supply, Efficiency Level: USA DOE Level VI / Eco-design Directive 2009/125/EC, (EU) 2019/1782, Case Color/Style: GlobTek Black, Wall Plug-in, Regulated Switchmode AC-DC Power Supply AC Adaptor, Input Rating: 100-240V~, 50/60Hz, Euro Plug Fixed , Output Rating: 18W, 10.0V@1.8A, Output Configuration: 1500 mm, 20/2 Cond, UL 2468, Female Barrel 5.5 * 2.5 * 11mm with internal Spring Clip and Locking Notch or Equal, Ferrite: None, GlobTek Black, GT Cord # C14357, Pin Out: Center Positive (+V), Blades/Input Cord: (Order Separately), Approvals: CE; EAC; China RoHS; Double Insulation; Level VI; CB 62368; RoHS; Ukraine; WEEE; LPS 62368; Morocco;</p>
	<p>Model No. GT-86181-1810 -W2E</p>
	<p>Part No./Ordering No. WR9MU1800LCP-F(R6B) <span style="float: right;">Rev A</span></p>

Notes/Modifications/Customizations (notes in this section supersede the values shown in the standard spec):  
DIMENSIONS ARE IN MM UNLESS SPECIFIED OTHERWISE.

<p>GlobTek, Inc. www.globtek.com 186 Veterans Drive, Northvale, NJ 07647 Tel. (201) 784-1000 Fax (201) 784-0111</p>	<p>Drawing Title: GT-86181-1810 -W2E, ICT/ITE Power Supply, Efficiency Level: USA DOE Level VI / Eco-design Directive 2009/125/EC, (EU) 2019/1782, Case Color/Style: GlobTek Black, Wall Plug-in, Regulated Switchmode AC-DC Power Supply AC Adaptor, Input Rating: 100-240V~, 50/60Hz, Euro Plug Fixed , Output Rating: 18W, 10.0V@1.8A, Output Configuration: 1500 mm, 20/2 Cond, UL 2468, Female Barrel 5.5 * 2.5 * 11mm with internal Spring Clip and Locking Notch or Equal, Ferrite: None, GlobTek Black, GT Cord # C14357, Pin Out: Center Positive (+V), Blades/Input Cord: (Order Separately), Approvals: CE; EAC; China RoHS; Double Insulation; Level VI; CB 62368; RoHS; Ukraine; WEEE; LPS 62368; Morocco;</p>
	<p>Model No. GT-86181-1810 -W2E</p>
	<p>Part No./Ordering No. WR9MU1800LCP-F(R6B) <span style="float: right;">Rev A</span></p>

## ELECTRICAL SPECIFICATIONS

### A) ELECTRICAL SPECIFICATIONS:

01. Input Voltage: Specified 90-264 Vac, Nameplate rated: 100-240Vac
02. Input Frequency: Specified 47-63 Hz, Nameplate rated 50-60Hz
03. Inrush Current: at full load, 25° C, cold start
04. Efficiency: Compliant with Efficiency Level VI and CoC Tier 2 standards
05. No Load Standby Power: <0.075W @ 230Vac
06. Line regulation: ±2% At nominal input voltage and full load
07. Total output regulation: ± 5%
08. Output Voltage: Tolerance ± 5%
09. Turn On Delay: 3 Seconds maximum at nominal input Voltage
10. Hold Up Time: 5ms min at nominal Input Voltage
11. Ripple Voltage: 300 mVp-p At 20 MHz, and output parallel with Low Impedance 0.1uF & 47uF capacitors. Temperature at 25°C, and nominal input voltage

### B) PROTECTION

01. Over voltage protection: Output shut down and auto restart
02. Short circuit protection: The adapter shall not be damaged by short the DC output to Ground
03. Over Load Protection: Output shut down and auto restart

### C) SAFETY

01. HI-POT : Input to output : 3000VAC or 4242VDC 10mA 1 minute
02. Leakage current: 0.25mA maximum, at nominal AC input voltage and frequency
03. ESD: 8KV(air) / 4KV (contact)

### D) OTHER:

01. MTBF: 200,000 Hours @ 25°C ambient temperature
02. Operating Temperature: 0°C to 40°C ambient temperature
03. Humidity Operating : 20% to 85%
04. Storage Temperature: -20°C to 60°C
05. RoHS 2: Complies with EU 2011/65/EU and China GB/T26572-2011

### E) ENCLOSURE

01. Housing: High impact plastic, 94V0 polycarbonate, non-vented
02. Size: 74.5 (L) \* 36 (W) \* 46(H) mm maximum
03. Weight : 107.0 g ±15%
04. Markings: Label and/or Pad Printed and/or Molded in the case

TO ADDRESS SYSTEM-LEVEL EMI CONCERNS, FERRITE CHOKES/BEADS MAY BE ADDED/REVISED UPON REQUEST. A SAMPLE KIT OF GLOBTEK'S STANDARD FERRITES IS AVAILABLE UNDER GLOBTEK P/N: EMI-MITIGATION-KIT1

FOR ADDITIONAL INFORMATION, PLEASE READ OUR WHITE PAPER AT:

<https://en.globtek.com/technical-articles/ferrite-kit-radiated-emi-suppression-kit-for-globtek-power-supplies-cable-assemblies>

#### PROPRIETARY INFORMATION

PROPRIETARY OF GLOBTEK, INC. ANY REPRODUCTION, DISCLOSURE OR USE OF THIS DRAWING, IN WHOLE OR IN PART, IS HEREBY PROHIBITED EXCEPT AS SPECIFIED IN

WRITING BY GLOBTEK, INC. © GlobTek, Inc. 2019 - 2021

quest /05/07/2021 8:01:12 AM CLONED FROM WR9HU1800LCPEUF(R6B)

<p>GlobTek, Inc.  www.globtek.com  186 Veterans Drive,  Northvale, NJ 07647  Tel. (201) 784-1000  Fax (201) 784-0111</p>	<p>Drawing Title: GT-86181-1810 -W2E, ICT/ITE Power Supply, Efficiency Level: USA DOE Level VI / Eco-design Directive 2009/125/EC, (EU) 2019/1782, Case Color/Style: GlobTek Black, Wall Plug-in, Regulated Switchmode AC-DC Power Supply AC Adaptor, Input Rating: 100-240V~, 50/60Hz, Euro Plug Fixed , Output Rating: 18W, 10.0V@1.8A, Output Configuration: 1500 mm, 20/2 Cond, UL 2468, Female Barrel 5.5 * 2.5 * 11mm with internal Spring Clip and Locking Notch or Equal, Ferrite: None, GlobTek Black, GT Cord # C14357, Pin Out: Center Positive (+V), Blades/Input Cord: (Order Separately), Approvals: CE; EAC; China RoHS; Double Insulation; Level VI; CB 62368; RoHS; Ukraine; WEEE; LPS 62368; Morocco;</p>
	<p>Model No. GT-86181-1810 -W2E</p>
	<p>Part No./Ordering No. WR9MU1800LCP-F(R6B) <span style="float: right;">Rev A</span></p>

INGRESS PROTECTION: Indoor Use

<p>GlobTek, Inc.  www.globtek.com  186 Veterans Drive,  Northvale, NJ 07647  Tel. (201) 784-1000  Fax (201) 784-0111</p>	<p>Drawing Title: GT-86181-1810 -W2E, ICT/ITE Power Supply, Efficiency Level: USA DOE Level VI / Eco-design Directive 2009/125/EC, (EU) 2019/1782, Case Color/Style: GlobTek Black, Wall Plug-in, Regulated Switchmode AC-DC Power Supply AC Adaptor, Input Rating: 100-240V~, 50/60Hz, Euro Plug Fixed , Output Rating: 18W, 10.0V@1.8A, Output Configuration: 1500 mm, 20/2 Cond, UL 2468, Female Barrel 5.5 * 2.5 * 11mm with internal Spring Clip and Locking Notch or Equal, Ferrite: None, GlobTek Black, GT Cord # C14357, Pin Out: Center Positive (+V), Blades/Input Cord: (Order Separately), Approvals: CE; EAC; China RoHS; Double Insulation; Level VI; CB 62368; RoHS; Ukraine; WEEE; LPS 62368; Morocco;</p> <p>Model No. GT-86181-1810 -W2E</p> <p>Part No./Ordering No. WR9MU1800LCP-F(R6B)</p>	<p>Rev A</p>
--	--	--------------

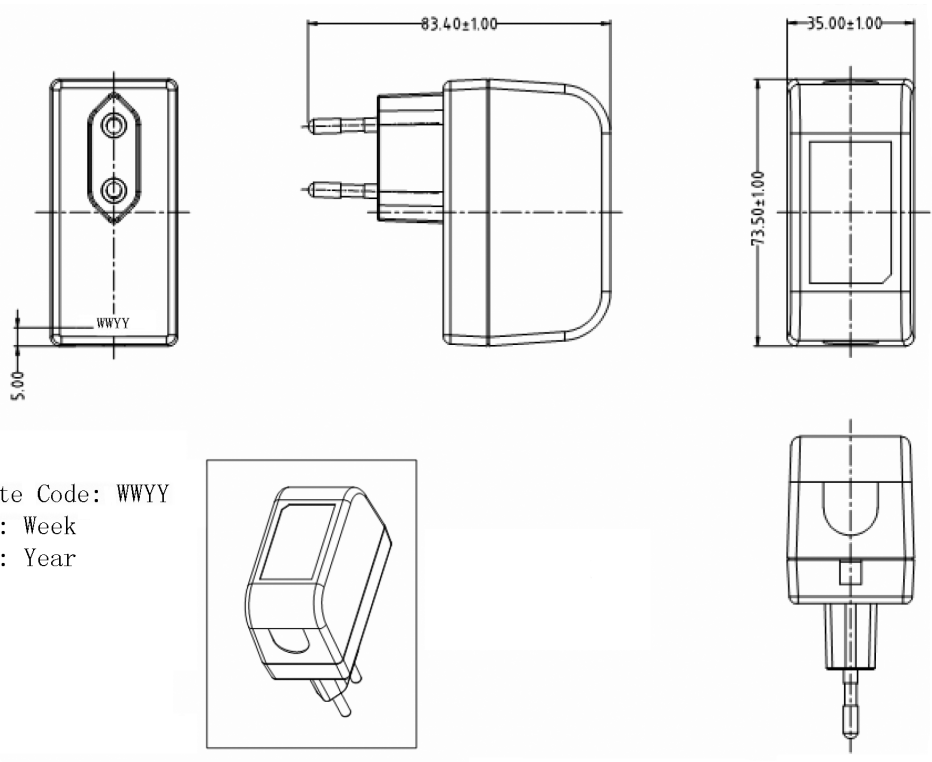

<p>GlobTek, Inc.  www.globtek.com  186 Veterans Drive,  Northvale, NJ 07647  Tel. (201) 784-1000  Fax (201) 784-0111</p>	<p>Drawing Title: GT-86181-1810 -W2E, ICT/ITE Power Supply, Efficiency Level: USA DOE Level VI / Eco-design Directive 2009/125/EC, (EU) 2019/1782, Case Color/Style: GlobTek Black, Wall Plug-in, Regulated Switchmode AC-DC Power Supply AC Adaptor, Input Rating: 100-240V~, 50/60Hz, Euro Plug Fixed , Output Rating: 18W, 10.0V@1.8A, Output Configuration: 1500 mm, 20/2 Cond, UL 2468, Female Barrel 5.5 * 2.5 * 11mm with internal Spring Clip and Locking Notch or Equal, Ferrite: None, GlobTek Black, GT Cord # C14357, Pin Out: Center Positive (+V), Blades/Input Cord: (Order Separately), Approvals: CE; EAC; China RoHS; Double Insulation; Level VI; CB 62368; RoHS; Ukraine: WEEE; LPS 62368; Morocco;</p> <p>Model No. GT-86181-1810 -W2E</p> <p>Part No./Ordering No. WR9MU1800LCP-F(R6B)</p>	<p>Rev A</p>
--	--	--------------

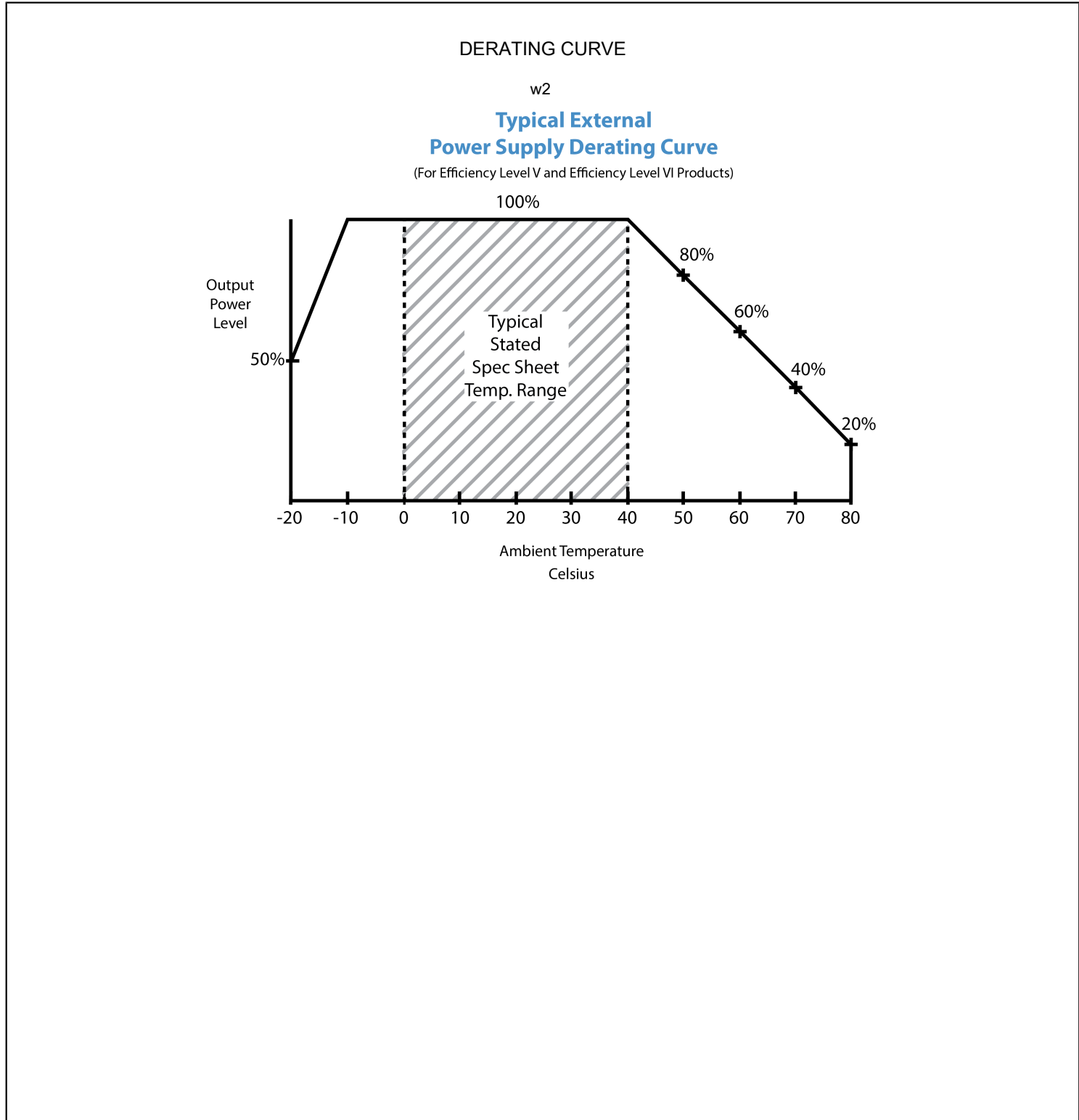

<p>GlobTek, Inc.  www.globtek.com  186 Veterans Drive,  Northvale, NJ 07647  Tel. (201) 784-1000  Fax (201) 784-0111</p>	<p>Drawing Title: GT-86181-1810 -W2E, ICT/ITE Power Supply, Efficiency Level: USA DOE Level VI / Eco-design Directive 2009/125/EC, (EU) 2019/1782, Case Color/Style: GlobTek Black, Wall Plug-in, Regulated Switchmode AC-DC Power Supply AC Adaptor, Input Rating: 100-240V~, 50/60Hz, Euro Plug Fixed , Output Rating: 18W, 10.0V@1.8A, Output Configuration: 1500 mm, 20/2 Cond, UL 2468, Female Barrel 5.5 * 2.5 * 11mm with internal Spring Clip and Locking Notch or Equal, Ferrite: None, GlobTek Black, GT Cord # C14357, Pin Out: Center Positive (+V), Blades/Input Cord: (Order Separately), Approvals: CE; EAC; China RoHS; Double Insulation; Level VI; CB 62368; RoHS; Ukraine; WEEE; LPS 62368; Morocco;</p> <p>Model No. GT-86181-1810 -W2E</p> <p>Part No./Ordering No. WR9MU1800LCP-F(R6B)</p>	<p>Rev A</p>
--	--	--------------

**INPUT CONFIGURATION**

(F1) Class II / Double Insulated

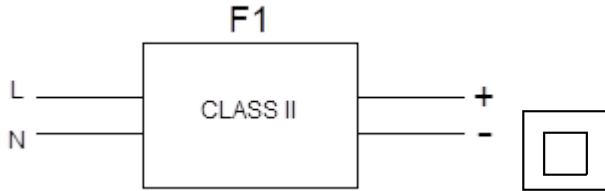

[Alternate grounding configurations](#) available upon request.

Blades/Cord Included:None:(Order Separately)

Blades/Cord Installed:None:(Order Separately)

European CEE 7/16 configuration:EN 50075 Europlug 2 PIN

The prongs of the Europlug are 19 mm long. They consist of a 9 mm long conductive tip of 4 mm diameter with a rounded ending, followed by a 10 mm long flexible insulated shaft of not more than 3.8 mm diameter. The two prongs are not exactly parallel and converge slightly; their centres are 19 mm apart at the tip and 18.6 mm apart at the base. The elasticity of the converging prongs provides sufficient contact force for the Europlug's current rating with a variety of socket-hole arrangements. The entire plug is 35.3 mm wide and 13.7 mm high, and must not exceed these dimensions within 18 mm behind its front plane (this allows for the recesses on many European socket types). The left and right side of the plug are formed by surfaces that are at 45° relative to the horizontal plan.

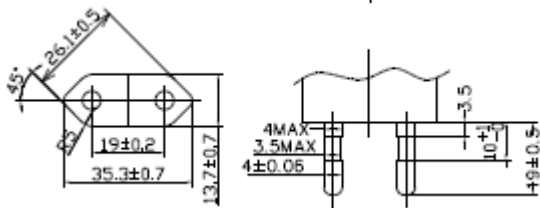

**PROPRIETARY INFORMATION**



<p>GlobTek, Inc. www.globtek.com 186 Veterans Drive, Northvale, NJ 07647 Tel. (201) 784-1000 Fax (201) 784-0111</p>	<p>Drawing Title: GT-86181-1810 -W2E, ICT/ITE Power Supply, Efficiency Level: USA DOE Level VI / Eco-design Directive 2009/125/EC, (EU) 2019/1782, Case Color/Style: GlobTek Black, Wall Plug-in, Regulated Switchmode AC-DC Power Supply AC Adaptor, Input Rating: 100-240V~, 50/60Hz, Euro Plug Fixed , Output Rating: 18W, 10.0V@1.8A, Output Configuration: 1500 mm, 20/2 Cond, UL 2468, Female Barrel 5.5 * 2.5 * 11mm with internal Spring Clip and Locking Notch or Equal, Ferrite: None, GlobTek Black, GT Cord # C14357, Pin Out: Center Positive (+V), Blades/Input Cord: (Order Separately), Approvals: CE; EAC; China RoHS; Double Insulation; Level VI; CB 62368; RoHS; Ukraine: WEEE; LPS 62368; Morocco;</p>
<p>Model No. GT-86181-1810 -W2E</p>	<p>Rev A</p>
<p>Part No./Ordering No. WR9MU1800LCP-F(R6B)</p>	

**OUTPUT CORD AND CONNECTOR: LCL/C14357**

ACTUAL CONNECTORS, OVERMOLDS, FERRITES MAY VARY SLIGHTLY FROM THE PICTURE BELOW

CABLE TYPE	UL 2468
CABLE LENGTH (mm)	1500
CABLE TOLERANCE (mm)	+150-0
WIRE GAUGE (AWG)	20
CONDUCTORS	2
HANK DIMENSION (mm)	70 ± 10
CABLE / CONNECTOR OVERMOLD COLOR	GlobTek Black
FERRITE TYPE / DIMENSION	None
FERRITE # OF TURNS <a href="#">(Definition)</a>	N/A
FERRITE DIMENSION FROM STRAIN RELIEF	N/A
FERRITE DIMENSION FROM PLUG	N/A
PLUG TYPE	Female Barrel 5.5 * 2.5 * 11mm with internal Spring Clip and Locking Notch or Equal
OUTPUT CONNECTOR GENDER	
OVERMOLDED	Yes
OVER MOLD ORIENTATION	Straight
CONNECTOR PIN OUT:	Center Positive (+V)
ADDITIONAL REQUIREMENTS	

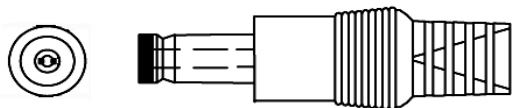

ADDITIONAL OUTPUT PLUG OPTIONS ARE AVAILABLE AT <https://www.globtek.com/connectors/>  
STANDARD PLUGS AND CONNECTORS CAN BE SEEN ONLINE AT <https://www.globtek.com/connectors/>  
CALCULATE VOLTAGE REGULATION/DROP WITH OUR ONLINE CALCULATOR: <https://en.globtek.com/output-cable-regulation-calculator/>

<p>GlobTek, Inc.  www.globtek.com  186 Veterans Drive,  Northvale, NJ 07647  Tel. (201) 784-1000  Fax (201) 784-0111</p>	<p>Drawing Title: GT-86181-1810 -W2E, ICT/ITE Power Supply, Efficiency Level: USA DOE Level VI / Eco-design Directive 2009/125/EC, (EU) 2019/1782, Case Color/Style: GlobTek Black, Wall Plug-in, Regulated Switchmode AC-DC Power Supply AC Adaptor, Input Rating: 100-240V~, 50/60Hz, Euro Plug Fixed , Output Rating: 18W, 10.0V@1.8A, Output Configuration: 1500 mm, 20/2 Cond, UL 2468, Female Barrel 5.5 * 2.5 * 11mm with internal Spring Clip and Locking Notch or Equal, Ferrite: None, GlobTek Black, GT Cord # C14357, Pin Out: Center Positive (+V), Blades/Input Cord: (Order Separately), Approvals: CE; EAC; China RoHS; Double Insulation; Level VI; CB 62368; RoHS; Ukraine; WEEE; LPS 62368; Morocco;</p>
	<p>Model No. GT-86181-1810 -W2E</p>
	<p>Part No./Ordering No. WR9MU1800LCP-F(R6B) <span style="float: right;">Rev A</span></p>

## OUTPUT CONNECTOR HOOK UP

TO ADDRESS SYSTEM-LEVEL EMI CONCERNS, FERRITE CHOKES/BEADS MAY BE ADDED/REVISED UPON REQUEST. A SAMPLE KIT OF GLOBTEK'S STANDARD FERRITES IS AVAILABLE UNDER GLOBTEK P/N: EMI-MITIGATION-KIT1

FOR ADDITIONAL INFORMATION, PLEASE READ OUR WHITE PAPER AT:

<https://en.globtek.com/technical-articles/ferrite-kit-radiated-emi-suppression-kit-for-globtek-power-supplies-cable-assemblies>

<p>GlobTek, Inc. www.globtek.com 186 Veterans Drive, Northvale, NJ 07647 Tel. (201) 784-1000 Fax (201) 784-0111</p>	<p>Drawing Title: GT-86181-1810 -W2E, ICT/ITE Power Supply, Efficiency Level: USA DOE Level VI / Eco-design Directive 2009/125/EC, (EU) 2019/1782, Case Color/Style: GlobTek Black, Wall Plug-in, Regulated Switchmode AC-DC Power Supply AC Adaptor, Input Rating: 100-240V~, 50/60Hz, Euro Plug Fixed , Output Rating: 18W, 10.0V@1.8A, Output Configuration: 1500 mm, 20/2 Cond, UL 2468, Female Barrel 5.5 * 2.5 * 11mm with internal Spring Clip and Locking Notch or Equal, Ferrite: None, GlobTek Black, GT Cord # C14357, Pin Out: Center Positive (+V), Blades/Input Cord: (Order Separately), Approvals: CE; EAC; China RoHS; Double Insulation; Level VI; CB 62368; RoHS; Ukraine: WEEE; LPS 62368; Morocco;</p> <p>Model No. GT-86181-1810 -W2E</p> <p>Part No./Ordering No. WR9MU1800LCP-F(R6B)</p>	<p>Rev A</p>
---	--	--------------

LABEL:L-1186

LABEL P/N:	Standard GT
MATERIAL:	Flat Thermal Transfer, Imprintable, Polyester Label and/or Pad Printed and/or Molded, and/or Laser Engraved in the case
BACKGROUND COLOR:	Black if housing is Black, White or Silver if housing is White or Gray.
TEXT COLOR:	White or Silver if label is Black Background for Black housing. Black if label is White or Silver background and Housing is White or Gray.
LABEL WIDTH (mm):	38.6
LABEL HEIGHT (mm):	22.1
SPECIAL BARCODE LABEL MATERIAL:	No

Below is the minimum information which will appear on the label. NOTE: in the logo area additional/actual positioning of symbols and text is subjected to change as per agency updates/requirements or additional model approvals become available. Regulatory certifications/label markings may be in logo area on the label or molded into the case housing outside the label area. Information will be shown via label and/or pad printed and/or molded and/or laser engraved in the case. \* Date code markings at GlobTek option

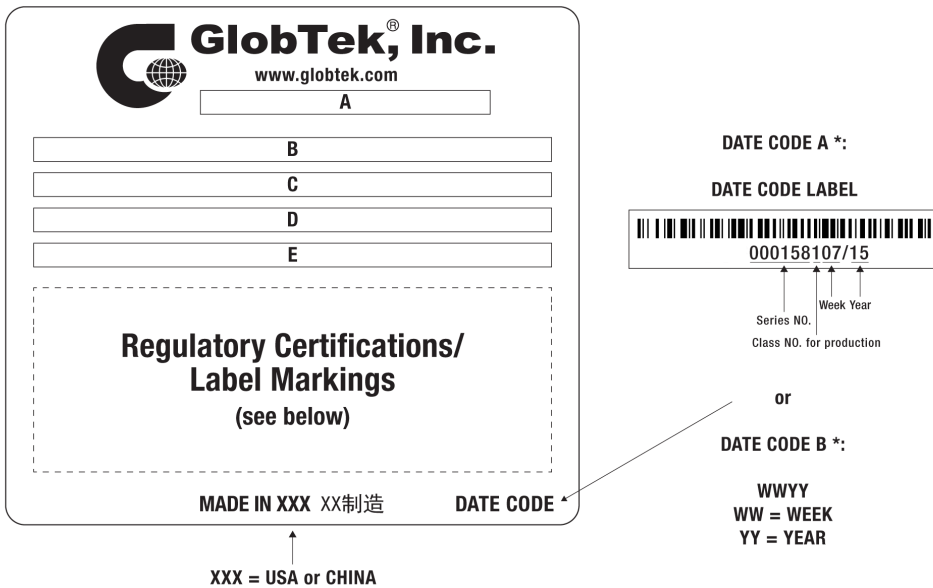

A=ICT/ITE Power Supply  
 B=P/N: (料号) WR9MU1800LCP-F(R6B)  
 C=Model (型号) GT-86181-1810 -W2E  
 D=Input (输入)100-240V~, 50/60Hz, 0.6 A  
 E=Output (输出)10.0 V  $\overline{\text{---}}$  1.8 A, 18.0W

<p>GlobTek, Inc. www.globtek.com 186 Veterans Drive, Northvale, NJ 07647 Tel. (201) 784-1000 Fax (201) 784-0111</p>	<p>Drawing Title: GT-86181-1810 -W2E, ICT/ITE Power Supply, Efficiency Level: USA DOE Level VI / Eco-design Directive 2009/125/EC, (EU) 2019/1782, Case Color/Style: GlobTek Black, Wall Plug-in, Regulated Switchmode AC-DC Power Supply AC Adaptor, Input Rating: 100-240V~, 50/60Hz, Euro Plug Fixed , Output Rating: 18W, 10.0V@1.8A, Output Configuration: 1500 mm, 20/2 Cond, UL 2468, Female Barrel 5.5 * 2.5 * 11mm with internal Spring Clip and Locking Notch or Equal, Ferrite: None, GlobTek Black, GT Cord # C14357, Pin Out: Center Positive (+V), Blades/Input Cord: (Order Separately), Approvals: CE; EAC; China RoHS; Double Insulation; Level VI; CB 62368; RoHS; Ukraine; WEEE; LPS 62368; Morocco;</p> <p>Model No. GT-86181-1810 -W2E</p> <p>Part No./Ordering No. WR9MU1800LCP-F(R6B)</p>	<p>Rev A</p>
---	--	--------------

AGENCY ONLINE DOCUMENTS	<a href="http://www.globtek.info/certs/GT-86181-W2/">http://www.globtek.info/certs/GT-86181-W2/</a>
CE EC-Declaration for Medical	<a href="#">Contact GlobTek for more information</a>
CE EC-Declaration for Industrial/Commercial/ITE	<a href="http://globtek.force.com/models/ec_declaration_product?id=01t0c000009EMeb&amp;i=2">http://globtek.force.com/models/ec_declaration_product?id=01t0c000009EMeb&amp;i=2</a>
CE EC-Declaration for Household	<a href="#">Contact GlobTek for more information</a>
UKCA-Declaration for Medical	<a href="#">Contact GlobTek for more information</a>
UKCA-Declaration for Industrial/Commercial/ITE	<a href="http://globtek.force.com/models/ukca_declaration_product?id=01t0c000009EMeb&amp;i=2">http://globtek.force.com/models/ukca_declaration_product?id=01t0c000009EMeb&amp;i=2</a>
UKCA-Declaration for Household	<a href="#">Contact GlobTek for more information</a>
Morocco SDoC Declaration	<a href="https://globtek.secure.force.com/models/Morocco_SDoC_Declaration?id=a00a000000FiiO1EAJ">https://globtek.secure.force.com/models/Morocco_SDoC_Declaration?id=a00a000000FiiO1EAJ</a>
RoHS/RoHS3 Declaration	<a href="https://www.globtek.com/pdf/rohs_cert/01t0c000009EMebAAG">https://www.globtek.com/pdf/rohs_cert/01t0c000009EMebAAG</a>
REACH Declaration	<a href="https://www.globtek.com/pdf/iso_certificates/REACH.pdf">https://www.globtek.com/pdf/iso_certificates/REACH.pdf</a>
Conflict Minerals Declaration	<a href="https://www.globtek.com/pdf/conflict-minerals.pdf">https://www.globtek.com/pdf/conflict-minerals.pdf</a>
Prop 65 Statement	<a href="https://en.globtek.com/prop-65-statement.pdf">https://en.globtek.com/prop-65-statement.pdf</a>

IPXY rating is based on 3rd party testing and customers should check suitability and test system level IPXY rating before ordering.

## Regulatory Certifications/Label Markings

LATEST PRODUCT/MODEL CERTIFICATIONS: <https://en.globtek.com/datasheet/id/a00a000000FiiO1>

AGENCY ONLINE DOCUMENTS: <http://www.globtek.info/certs/GT-86181-W2/>



(F1) Class II / Double Insulated

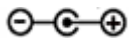

Center Positive (+V)

GlobTek, Inc. www.globtek.com 186 Veterans Drive, Northvale, NJ 07647 Tel. (201) 784-1000 Fax (201) 784-0111	Drawing Title: GT-86181-1810 -W2E, ICT/ITE Power Supply, Efficiency Level: USA DOE Level VI / Eco-design Directive 2009/125/EC, (EU) 2019/1782, Case Color/Style: GlobTek Black, Wall Plug-in, Regulated Switchmode AC-DC Power Supply AC Adaptor, Input Rating: 100-240V~, 50/60Hz, Euro Plug Fixed , Output Rating: 18W, 10.0V@1.8A, Output Configuration: 1500 mm, 20/2 Cond, UL 2468, Female Barrel 5.5 * 2.5 * 11mm with internal Spring Clip and Locking Notch or Equal, Ferrite: None, GlobTek Black, GT Cord # C14357, Pin Out: Center Positive (+V), Blades/Input Cord: (Order Separately), Approvals: CE; EAC; China RoHS; Double Insulation; Level VI; CB 62368; RoHS; Ukraine; WEEE; LPS 62368; Morocco;	
	Model No. GT-86181-1810 -W2E	Part No./Ordering No. WR9MU1800LCP-F(R6B)

## PACKAGING

Packing Spec P/N:	Standard WPI, Cellular packaging
Box Qty:	120
Gift Box Size (mm):	Cellular Packaing
Gift Box Color:	None
Master Carton Size (mm):	495 x 345 x 296
Master Carton Cubic Volume (m³):	0.05
Master GW (Kg):	0.0 kg
BLADES INCLUDED:	None: (Order Separately)
BLADE/CORD INSTALLED:	None: (Order Separately)
USER MANUAL*:	
USER MANUAL WEB LINK:	

\* This specification sheet is considered the user manual for all applications. It is expected that the buyer of this product will use it to formulate their own user manual for their end product and a user manual specifically for the power adapter is not usually required. If a user manual is not specifically listed above then none will be provided with this unit.

<p>GlobTek, Inc.  www.globtek.com  186 Veterans Drive,  Northvale, NJ 07647  Tel. (201) 784-1000  Fax (201) 784-0111</p>	<p>Drawing Title: GT-86181-1810 -W2E, ICT/ITE Power Supply, Efficiency Level: USA DOE Level VI / Eco-design Directive 2009/125/EC, (EU) 2019/1782, Case Color/Style: GlobTek Black, Wall Plug-in, Regulated Switchmode AC-DC Power Supply AC Adaptor, Input Rating: 100-240V~, 50/60Hz, Euro Plug Fixed , Output Rating: 18W, 10.0V@1.8A, Output Configuration: 1500 mm, 20/2 Cond, UL 2468, Female Barrel 5.5 * 2.5 * 11mm with internal Spring Clip and Locking Notch or Equal, Ferrite: None, GlobTek Black, GT Cord # C14357, Pin Out: Center Positive (+V), Blades/Input Cord: (Order Separately), Approvals: CE; EAC; China RoHS; Double Insulation; Level VI; CB 62368; RoHS; Ukraine; WEEE; LPS 62368; Morocco;</p> <p>Model No. GT-86181-1810 -W2E</p> <p>Part No./Ordering No. WR9MU1800LCP-F(R6B)</p>	<p>Rev A</p>
--	--	--------------

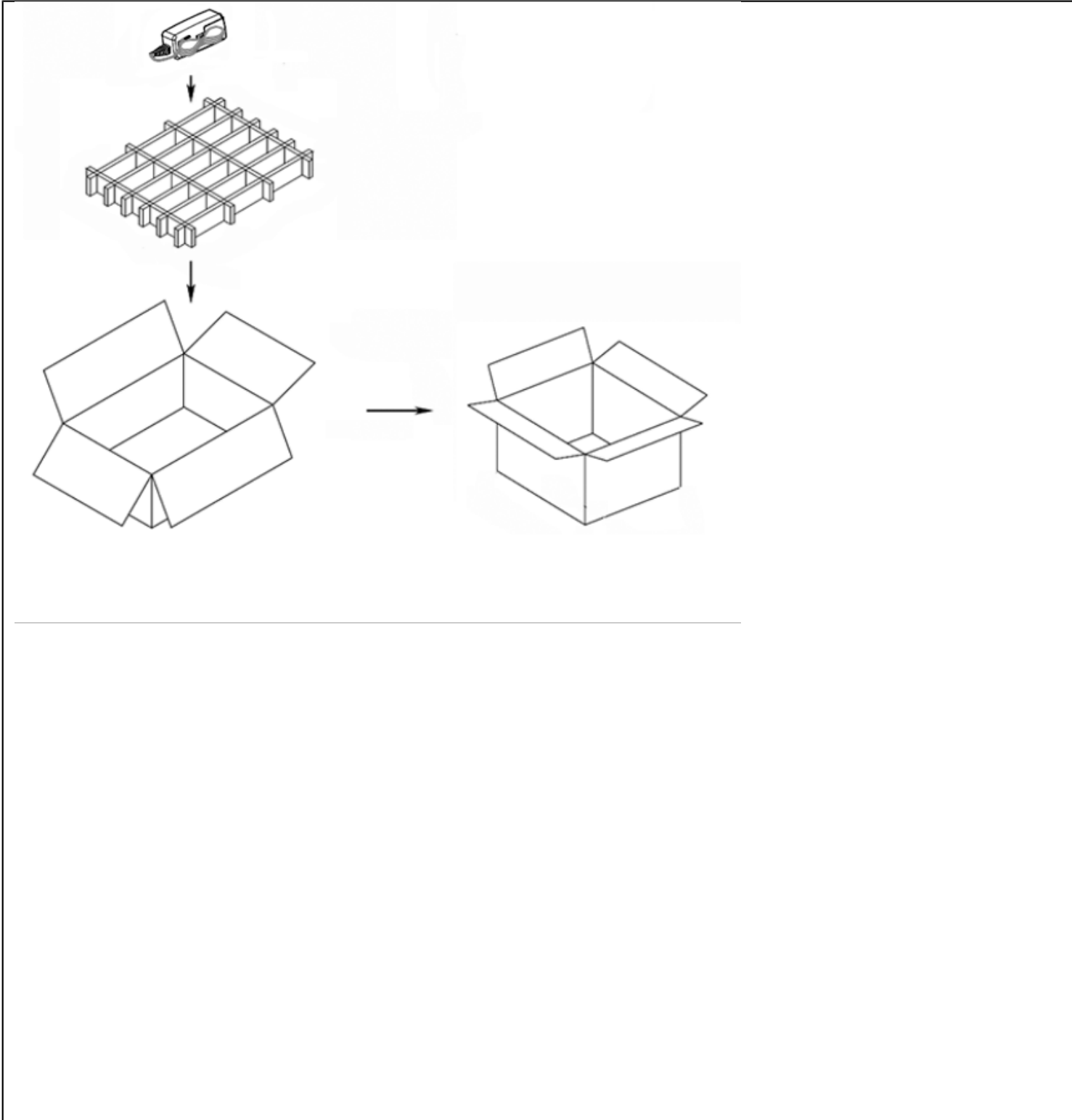

<p>GlobTek, Inc.  www.globtek.com  186 Veterans Drive,  Northvale, NJ 07647  Tel. (201) 784-1000  Fax (201) 784-0111</p>	<p>Drawing Title: GT-86181-1810 -W2E, ICT/ITE Power Supply, Efficiency Level: USA DOE Level VI / Eco-design Directive 2009/125/EC, (EU) 2019/1782, Case Color/Style: GlobTek Black, Wall Plug-in, Regulated Switchmode AC-DC Power Supply AC Adaptor, Input Rating: 100-240V~, 50/60Hz, Euro Plug Fixed , Output Rating: 18W, 10.0V@1.8A, Output Configuration: 1500 mm, 20/2 Cond, UL 2468, Female Barrel 5.5 * 2.5 * 11mm with internal Spring Clip and Locking Notch or Equal, Ferrite: None, GlobTek Black, GT Cord # C14357, Pin Out: Center Positive (+V), Blades/Input Cord: (Order Separately), Approvals: CE; EAC; China RoHS; Double Insulation; Level VI; CB 62368; RoHS; Ukraine; WEEE; LPS 62368; Morocco;</p>
	<p>Model No. GT-86181-1810 -W2E</p>
	<p>Part No./Ordering No. WR9MU1800LCP-F(R6B) <span style="float: right;">Rev A</span></p>

## INSTRUCTIONS TO THE OEM SYSTEMS ENGINEER

It is the responsibility of the OEM systems engineer to provide the end system user instructions and warnings for the use of this product in the end system.

If an input cord is required for this product, AC Mains voltage should be provided to the power supply by a power supply cord approved to the national standards of the country in which it will be used.

This power supply is not designed to be repaired. No serviceable parts inside. A blown internal fuse is an indication of catastrophic failure of circuit component(s). If a Failure Analysis is required for a failed power supply/battery charger, please return the damaged unit to GlobTek for an accurate determination of the root cause of the failure.

EMC Compliance of the complete OEM product, including the GlobTek power supply/battery charger needs to be verified by the OEM systems engineer.

## INSTRUCTION SHEET

### PROPRIETARY INFORMATION