

GloTek, Inc. www.globtek.com 186 Veterans Drive, Northvale, NJ 07647 Tel. (201) 784-1000 Fax (201) 784-0111	Drawing Title: GTM91110P24024-CA-S, ITE / Medical Power Supply, Efficiency Level: N/A, Case Color/Style: PANTONE BLUE 072 UP or similar, Enclosed-Metal, Regulated Switchmode AC-DC Power Supply AC Adaptor, Input Rating: 100-240V~, 50-60 Hz, Molex Header (or equal) , Output Rating: 200W, 24.0V@8.33A, Output Configuration: N/A mm, N/A/6 Cond, , MOLEX 6-PIN FRICTION LOCK HEADER P/N 26-60-4060 MATES WITH PN: 09-50-3061, Ferrite: None, N/A, GT Cord # C1196, Pin Out: Pins 1,2,3: V+, Pins 4,5,6: Common, Blades/Input Cord: Not Applicable, Approvals: CE; SIQ; SIQ; WEEE; RoHS; China RoHS; Ukraine; FCC; VCCI; GOST-R; CB 60601-1; cETLus 60601-1 3rd; CE; CB 60950; Book 60601; Class I;	
	Model No. GTM91110P24024-CA-S	Rev F
Part No./Ordering No. GTM91110P24024CAS(R)		

REVISION HISTORY

REV	DESCRIPTION	SUB	DATE	APPROVED
F	UPDATE TEMPLATE, Update electrical specifications to include Earth Leakage Current & Touch Current; Storage Temp -10C to 85C. Change AC Input CON 1 to 3 position Header, Molex p/n 26-60-4030 & revise pin assignment; show lug for Class I Earth Ground. Remove CQC PSE. Update CB to 3rd Operating Instructions. Update 60601-1 to cETLus 3rd. Update Instruction Sheet # 8. DC input end user instructions.		09/29/2014	QA
E	UPDATE MODEL NUMBER TO GTM91110P24024-CA-S		02/17/2014	QA
D	UPDATE LABEL 1 DIMENSIONS		11/05/2013	QA
C	UPDATE LABELS, UPDATE AVAILABLE WATTAGE WITH PERFORATED ENCLOSURE		09/18/2013	QA
B	LABEL: REMOVE 'RU' SYMBOL, OP CURRENT=4.0A, ADD UKRAINE, PSE SIQ FILE #; UPDATE PACKAGING		07/16/2013	QA
A	INITIAL RELEASE		06/28/2013	QA

In Addition to GlobTek Inc.'s renewed ISO9001:2015 - Quality Management System Certification, GlobTek Inc. is now certified to:

ISO13485:2016 - Medical Devices Quality Management System Certification
ISO14001:2015 - Environmental Management System Certification

ISO Certificates are available online at <https://www.globtek.com/iso-certificates/>

Customer Approval of Specification:

Please approve, sign and send back to GlobTek so we can complete order processing.

A delay in receipt of this form will delay delivery schedule.

Company Name:

Customer P/N:

Quote Number:

Date:

Authorized Representative Name:

Authorized Representative Signature:

The acceptance of this specification and use of the product described in this document indicates the acceptance and binding of the customer to Globtek terms and conditions, which supersede all other agreements, terms, and conditions (<https://en.globtek.com/terms-and-conditions/>).

The purchaser of this product (Customer) agrees that it is their sole responsibility to determine suitability/fitness of the product described in this specification for their application and to take precautions for protection against any hazards attendant to the handling and use of the product.

Footnote:

GlobTek Inc. will not be liable for the safety and performance of these power supplies if unauthorized access and repair occurs. End user should consult applicable UL, CSA or EN standards for proper installation instruction.

Limitation of Use:

GlobTek products are intended for use with commercial, medical, and/or industrial equipment only. GlobTek product are not authorized for use as mission critical components in life support hazardous environment, nuclear or aircraft applications without prior written approval from the CEO of GlobTek Inc. Contents of this document are subject to change without prior notice.

PROPRIETARY INFORMATION

PROPRIETARY OF GLOBTEK, INC. ANY REPRODUCTION, DISCLOSURE OR USE OF THIS DRAWING, IN WHOLE OR IN PART, IS HEREBY PROHIBITED EXCEPT AS SPECIFIED IN WRITING BY GLOBTEK, INC. © GlobTek, Inc. 2012 - 2020

GlobTek, Inc. www.globtek.com 186 Veterans Drive, Northvale, NJ 07647 Tel. (201) 784-1000 Fax (201) 784-0111	Drawing Title: GTM91110P24024-CA-S, ITE / Medical Power Supply, Efficiency Level: N/A, Case Color/Style: PANTONE BLUE 072 UP or similar, Enclosed-Metal, Regulated Switchmode AC-DC Power Supply AC Adaptor, Input Rating: 100-240V~, 50-60 Hz, Molex Header (or equal) , Output Rating: 200W, 24.0V@8.33A, Output Configuration: N/A mm, N/A/6 Cond, , MOLEX 6-PIN FRICTION LOCK HEADER P/N 26-60-4060 MATES WITH PN: 09-50-3061, Ferrite: None, N/A, GT Cord # C1196, Pin Out: Pins 1,2,3: V+, Pins 4,5,6: Common, Blades/Input Cord: Not Applicable, Approvals: CE; SIQ; SIQ; WEEE; RoHS; China RoHS; Ukraine; FCC; VCCI; GOST-R; CB 60601-1; cETLus 60601-1 3rd; CE; CB 60950; Book 60601; Class I;
	Model No. GTM91110P24024-CA-S Part No./Ordering No. GTM91110P24024CAS(R)

POWER SUPPLY INFORMATION

TYPE:	Enclosed-Metal
TECHNOLOGY:	Regulated Switchmode AC-DC Power Supply AC Adaptor
CASE COLOR:	PANTONE BLUE 072 UP or similar
NAMEPLATE RATED INPUT:	100-240V~, 50-60 Hz, 4.0A
INPUT CONFIG:	Molex Header (or equal)
WATTS:	200.0
VOLTS OUT:	24.0
CURRENT OUT (Amps):	8.33
INGRESS PROTECTION:	
GROUNDING CONFIGURATION:	(F1) Class II / Double Insulated
EFFICIENCY LEVEL:	
OUTPUT CONFIGURATION:	N/A mm, N/A/6 Cond, , MOLEX 6-PIN FRICTION LOCK HEADER P/N 26-60-4060 MATES WITH PN: 09-50-3061, Ferrite: None, N/A, GT Cord # C1196
CONNECTOR PIN OUT:	Pins 1,2,3: V+, Pins 4,5,6: Common
LABEL SPECS:	Standard GT,L-1186
SPECIAL BARCODE LABEL	
MATERIAL:	
PACK SPEC:	
USER MANUAL:	

PROPRIETARY INFORMATION

PROPRIETARY OF GLOBTEK, INC. ANY REPRODUCTION, DISCLOSURE OR USE OF THIS DRAWING, IN WHOLE OR IN PART, IS HEREBY PROHIBITED EXCEPT AS SPECIFIED IN WRITING BY GLOBTEK, INC. © GlobTek, Inc. 2012 - 2020

<p>GlobTek, Inc. www.globtek.com 186 Veterans Drive, Northvale, NJ 07647 Tel. (201) 784-1000 Fax (201) 784-0111</p>	<p>Drawing Title: GTM91110P24024-CA-S, ITE / Medical Power Supply, Efficiency Level: N/A, Case Color/Style: PANTONE BLUE 072 UP or similar, Enclosed-Metal, Regulated Switchmode AC-DC Power Supply AC Adaptor, Input Rating: 100-240V~, 50-60 Hz, Molex Header (or equal) , Output Rating: 200W, 24.0V@8.33A, Output Configuration: N/A mm, N/A/6 Cond, , MOLEX 6-PIN FRICTION LOCK HEADER P/N 26-60-4060 MATES WITH PN: 09-50-3061, Ferrite: None, N/A, GT Cord # C1196, Pin Out: Pins 1,2,3: V+, Pins 4,5,6: Common, Blades/Input Cord: Not Applicable, Approvals: CE; SIQ; SIQ; WEEE; RoHS; China RoHS; Ukraine; FCC; VCCI; GOST-R; CB 60601-1; cETLus 60601-1 3rd; CE; CB 60950; Book 60601; Class I;</p>
	<p>Model No. GTM91110P24024-CA-S</p>
	<p>Part No./Ordering No. GTM91110P24024CAS(R) Rev F</p>

Notes/Modifications/Customizations (notes in this section supersede the values shown in the standard spec):
DIMENSIONS ARE IN MM UNLESS SPECIFIED OTHERWISE.

GlobTek, Inc. www.globtek.com 186 Veterans Drive, Northvale, NJ 07647 Tel. (201) 784-1000 Fax (201) 784-0111	Drawing Title: GTM91110P24024-CA-S, ITE / Medical Power Supply, Efficiency Level: N/A, Case Color/Style: PANTONE BLUE 072 UP or similar, Enclosed-Metal, Regulated Switchmode AC-DC Power Supply AC Adaptor, Input Rating: 100-240V~, 50-60 Hz, Molex Header (or equal) , Output Rating: 200W, 24.0V@8.33A, Output Configuration: N/A mm, N/A/6 Cond, , MOLEX 6-PIN FRICTION LOCK HEADER P/N 26-60-4060 MATES WITH PN: 09-50-3061, Ferrite: None, N/A, GT Cord # C1196, Pin Out: Pins 1,2,3: V+, Pins 4,5,6: Common, Blades/Input Cord: Not Applicable, Approvals: CE; SIQ; SIQ; WEEE; RoHS; China RoHS; Ukraine; FCC; VCCI; GOST-R; CB 60601-1; cETLus 60601-1 3rd; CE; CB 60950; Book 60601; Class I;	
	Model No. GTM91110P24024-CA-S	
	Part No./Ordering No. GTM91110P24024CAS(R)	Rev F

ELECTRICAL SPECIFICATIONS

A) ELECTRICAL SPECIFICATIONS:

01. Input Voltage: Specified 90-264 Vac, Nameplate rated 100-240 Vac
02. Input Frequency: Specified 47-63 Hz, Nameplate rated 50/60 Hz
03. Inrush current: Cold start @ 25°C, 40A @ 115Vac, 80A @ 230Vac
04. Efficiency: 85% to 90% typical at full load, 120-240Vac input
05. Power factor: 0.98 typical at full load, 230Vac input
06. Turn on delay: 5 Seconds maximum, (3 seconds max option)
07. Load regulation: $\pm 1\%$ Measured at the connector side
08. Line regulation: $\pm 0.2\%$ Measured at the connector side
09. Output Ripple protection (Peak to Peak): $\pm 1\%$ maximum of nominal output voltage measured at 20 MHz bandwidth with 0.1 μ f ceramic capacitor in parallel with a low impedance 47 μ f electrolytic capacitor located 200mm from the end of the output connector
10. Turn on/off overshoot: 5% Maximum, 1mS recovery time
11. Hold up time: 8 mS @ 300W load, 10mS@200W load, 16mS@150W load at 115Vac input
12. Transient response: 2% Maximum deviation, returns to initial condition in 3 ms max for 25% load step, from 10% to 100% of rated load
13. Remote sense (optional): compensates for up to 0.5V voltage drop in output wiring.
Power supply will operate correctly, with or without remote sense pins hooked up.
14. Auxillary Output: For forced air fan 12V @ 250mA, if convection cooled 12V @ 150mA. Other output voltages and current ratings from 5V to 24V available, contact factory for availability.
15. Indicator: Green LED for output presence

B) PROTECTION

01. Input Protection: Input line fusing and 300Vac MOV
02. Short circuit: Protected. Unit will autorecover upon removal of short
03. Overload protection: Autorecover upon removal of overload
 - 150W, 175% - 210% of nominal power rating
 - 200W, 130% - 160% of nominal power rating
 - 240W, 110% - 130% of nominal power rating
 - 300W, 110% - 130% of nominal power rating
04. Over voltage: Protected at 110- 140% of nominal output voltage, latched type. AC cycling required to restore output. Autorecovery type OVP is an option, contact factory for availability.
05. Fan output protection: 3 Pin Linear Regulator, short circuit proof

C) SAFETY

01. Dielectric Withstand Voltage: 4000Vac or 5656Vdc from input to output,
On Class I models, 2500Vac or 3535Vdc from input to earth
02. Earth Leakage Current:
 - Class I Input Models: Does not exceed 500uA
 - Class II Input Models: Does not apply
03. Touch Current: Does not exceed 100uA, output terminations to earth
04. Output terminations rated as SELV, and Means of Operator Protection

D) OTHER:

01. MTBF: 200,000 Hours @ 25°C ambient temperature
02. Operating Temperature Range:
 - 10°C to 50°C @ 100% output power rating

PROPRIETARY INFORMATION

PROPRIETARY OF GLOBTEK, INC. ANY REPRODUCTION, DISCLOSURE OR USE OF THIS DRAWING, IN WHOLE OR IN PART, IS HEREBY PROHIBITED EXCEPT AS SPECIFIED IN WRITING BY GLOBTEK, INC. © GlobTek, Inc. 2012 - 2020

<p>GlobTek, Inc. www.globtek.com 186 Veterans Drive, Northvale, NJ 07647 Tel. (201) 784-1000 Fax (201) 784-0111</p>	<p>Drawing Title: GTM91110P24024-CA-S, ITE / Medical Power Supply, Efficiency Level: N/A, Case Color/Style: PANTONE BLUE 072 UP or similar, Enclosed-Metal, Regulated Switchmode AC-DC Power Supply AC Adaptor, Input Rating: 100-240V~, 50-60 Hz, Molex Header (or equal) , Output Rating: 200W, 24.0V@8.33A, Output Configuration: N/A mm, N/A/6 Cond, , MOLEX 6-PIN FRICTION LOCK HEADER P/N 26-60-4060 MATES WITH PN: 09-50-3061, Ferrite: None, N/A, GT Cord # C1196, Pin Out: Pins 1,2,3: V+, Pins 4,5,6: Common, Blades/Input Cord: Not Applicable, Approvals: CE; SIQ; SIQ; WEEE; RoHS; China RoHS; Ukraine; FCC; VCCI; GOST-R; CB 60601-1; cETLus 60601-1 3rd; CE; CB 60950; Book 60601; Class I;</p> <p>Model No. GTM91110P24024-CA-S</p> <p>Part No./Ordering No. GTM91110P24024CAS(R)</p>	<p>Rev F</p>
---	---	--------------

-10°C to 70°C @ 50% output power derating

03. Cooling:

Open Frame 150W Series: Convection

Open Frame 240W and 300W Series: 20 CFM Forced Air Cooling

Perforated Plastic Housing 200W Series: 20 CFM Forced Air Cooling,
with convection cooling 50% derated (100W) output capability.

04. Relative Humidity: operating 0% to 90% Non-condensing

05. Storage Temperature: -30°C to 85°C

06. Altitude: up to 2000 meter

07. Random vibration/transient drop: MIL-STD 810E

E) MECHANICAL FORMAT:

150W, 240W and 300W Open Frame version

Size: 127*76.2*43 mm

Weight: 470 grams

200W Perforated Plastic Enclosure version

Size: 140*87.6*51.9 mm

Weight: 620 grams

TO ADDRESS SYSTEM-LEVEL EMI CONCERNS, FERRITE CHOKES/BEADS MAY BE ADDED/REVISED UPON REQUEST. A SAMPLE KIT OF GLOBTEK'S STANDARD FERRITES IS AVAILABLE UNDER GLOBTEK P/N: EMI-MITIGATION-KIT1

FOR ADDITIONAL INFORMATION, PLEASE READ OUR WHITE PAPER AT:

<https://en.globtek.com/technical-articles/ferrite-kit-radiated-emi-suppression-kit-for-globtek-power-supplies-cable-assemblies>

<p>GlobTek, Inc. www.globtek.com 186 Veterans Drive, Northvale, NJ 07647 Tel. (201) 784-1000 Fax (201) 784-0111</p>	<p>Drawing Title: GTM91110P24024-CA-S, ITE / Medical Power Supply, Efficiency Level: N/A, Case Color/Style: PANTONE BLUE 072 UP or similar, Enclosed-Metal, Regulated Switchmode AC-DC Power Supply AC Adaptor, Input Rating: 100-240V~, 50-60 Hz, Molex Header (or equal) , Output Rating: 200W, 24.0V@8.33A, Output Configuration: N/A mm, N/A/6 Cond, , MOLEX 6-PIN FRICTION LOCK HEADER P/N 26-60-4060 MATES WITH PN: 09-50-3061, Ferrite: None, N/A, GT Cord # C1196, Pin Out: Pins 1,2,3: V+, Pins 4,5,6: Common, Blades/Input Cord: Not Applicable, Approvals: CE; SIQ; SIQ; WEEE; RoHS; China RoHS; Ukraine; FCC; VCCI; GOST-R; CB 60601-1; cETLus 60601-1 3rd; CE; CB 60950; Book 60601; Class I;</p> <p>Model No. GTM91110P24024-CA-S</p> <p>Part No./Ordering No. GTM91110P24024CAS(R)</p>	<p>Rev F</p>
--	---	--------------

AIRFLOW DIRECTION FOR 200W VERSION

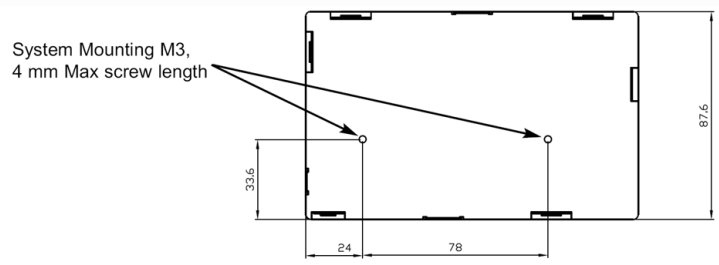
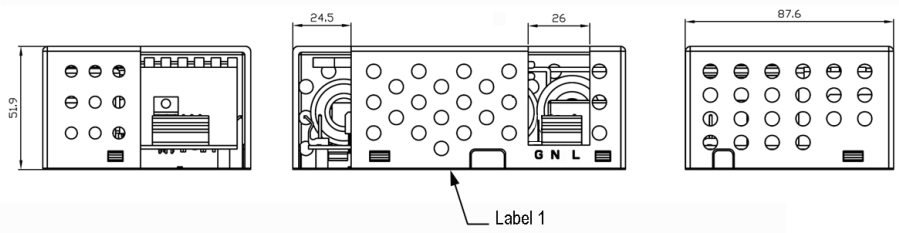
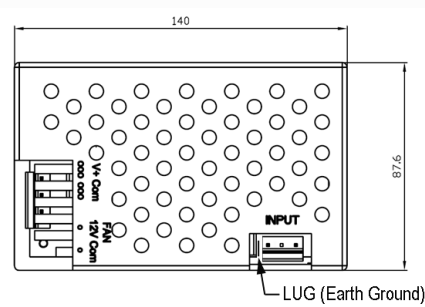
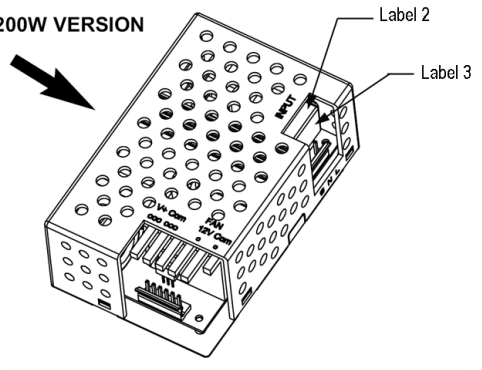

<p>GlobTek, Inc. www.globtek.com 186 Veterans Drive, Northvale, NJ 07647 Tel. (201) 784-1000 Fax (201) 784-0111</p>	<p>Drawing Title: GTM91110P24024-CA-S, ITE / Medical Power Supply, Efficiency Level: N/A, Case Color/Style: PANTONE BLUE 072 UP or similar, Enclosed-Metal, Regulated Switchmode AC-DC Power Supply AC Adaptor, Input Rating: 100-240V~, 50-60 Hz, Molex Header (or equal) , Output Rating: 200W, 24.0V@8.33A, Output Configuration: N/A mm, N/A/6 Cond, , MOLEX 6-PIN FRICTION LOCK HEADER P/N 26-60-4060 MATES WITH PN: 09-50-3061, Ferrite: None, N/A, GT Cord # C1196, Pin Out: Pins 1,2,3: V+, Pins 4,5,6: Common, Blades/Input Cord: Not Applicable, Approvals: CE; SIQ; SIQ; WEEE; RoHS; China RoHS; Ukraine; FCC; VCCI; GOST-R; CB 60601-1; cETLus 60601-1 3rd; CE; CB 60950; Book 60601; Class I;</p>
	<p>Model No. GTM91110P24024-CA-S</p> <p>Part No./Ordering No. GTM91110P24024CAS(R) Rev F</p>

Label 1
Position Label 1 on outside bottom plate

Label 2
Material: White art paper with Black nomenclature and is attached on top of CX1

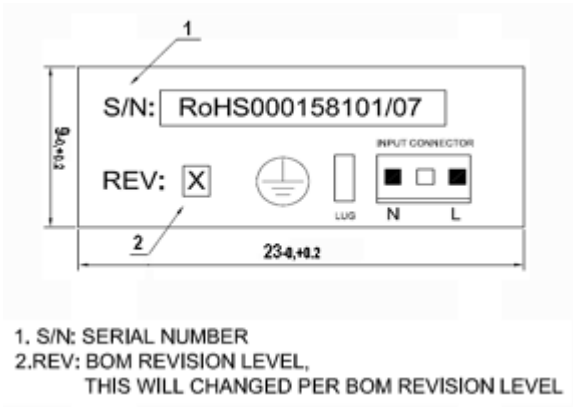

Label 3
Material: White art paper with Black nomenclature and is attached on side of CX1

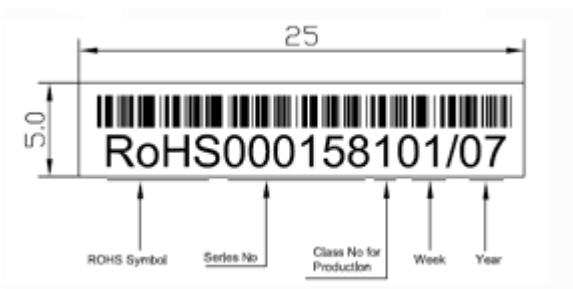

<p>GlobTek, Inc. www.globtek.com 186 Veterans Drive, Northvale, NJ 07647 Tel. (201) 784-1000 Fax (201) 784-0111</p>	<p>Drawing Title: GTM91110P24024-CA-S, ITE / Medical Power Supply, Efficiency Level: N/A, Case Color/Style: PANTONE BLUE 072 UP or similar, Enclosed-Metal, Regulated Switchmode AC-DC Power Supply AC Adaptor, Input Rating: 100-240V~, 50-60 Hz, Molex Header (or equal) , Output Rating: 200W, 24.0V@8.33A, Output Configuration: N/A mm, N/A/6 Cond, , MOLEX 6-PIN FRICTION LOCK HEADER P/N 26-60-4060 MATES WITH PN: 09-50-3061, Ferrite: None, N/A, GT Cord # C1196, Pin Out: Pins 1,2,3: V+, Pins 4,5,6: Common, Blades/Input Cord: Not Applicable, Approvals: CE; SIQ; SIQ; WEEE; RoHS; China RoHS; Ukraine; FCC; VCCI; GOST-R; CB 60601-1; cETLus 60601-1 3rd; CE; CB 60950; Book 60601; Class I;</p> <p>Model No. GTM91110P24024-CA-S</p> <p>Part No./Ordering No. GTM91110P24024CAS(R)</p>	<p>Rev F</p>
--	---	--------------

DERATING CURVE

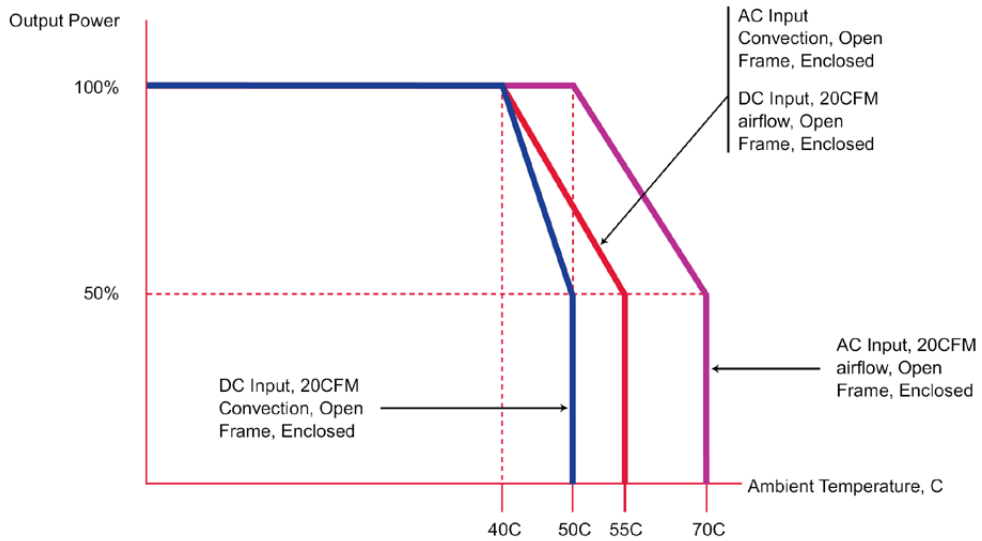

<p>GlobTek, Inc. www.globtek.com 186 Veterans Drive, Northvale, NJ 07647 Tel. (201) 784-1000 Fax (201) 784-0111</p>	<p>Drawing Title: GTM91110P24024-CA-S, ITE / Medical Power Supply, Efficiency Level: N/A, Case Color/Style: PANTONE BLUE 072 UP or similar, Enclosed-Metal, Regulated Switchmode AC-DC Power Supply AC Adaptor, Input Rating: 100-240V~, 50-60 Hz, Molex Header (or equal) , Output Rating: 200W, 24.0V@8.33A, Output Configuration: N/A mm, N/A/6 Cond, , MOLEX 6-PIN FRICTION LOCK HEADER P/N 26-60-4060 MATES WITH PN: 09-50-3061, Ferrite: None, N/A, GT Cord # C1196, Pin Out: Pins 1,2,3: V+, Pins 4,5,6: Common, Blades/Input Cord: Not Applicable, Approvals: CE; SIQ; SIQ; WEEE; RoHS; China RoHS; Ukraine; FCC; VCCI; GOST-R; CB 60601-1; cETLus 60601-1 3rd; CE; CB 60950; Book 60601; Class I;</p> <p>Model No. GTM91110P24024-CA-S</p> <p>Part No./Ordering No. GTM91110P24024CAS(R)</p>	<p>Rev F</p>
---	---	--------------

INPUT CONFIGURATION

(F1) Class II / Double Insulated



[Alternate grounding configurations](#) available upon request.

Molex 26-60-4030 3 Position Header Pin 1: Line, Pin 2: Removed, PIN 3: Neutral

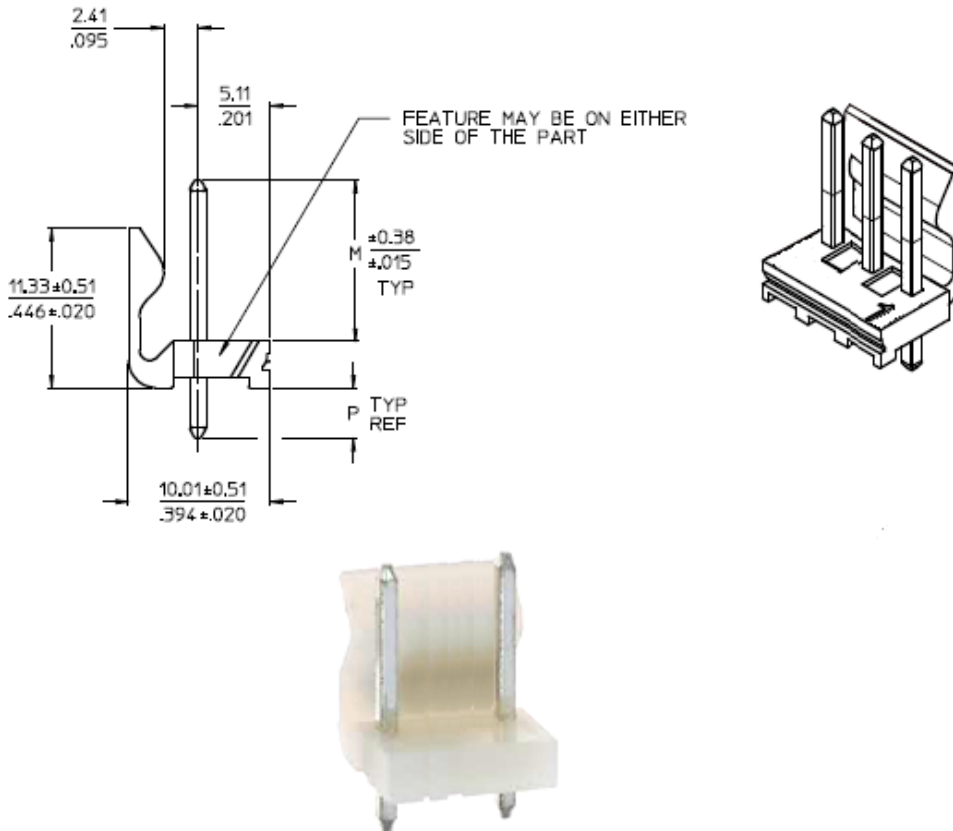

<p>GlobTek, Inc. www.globtek.com 186 Veterans Drive, Northvale, NJ 07647 Tel. (201) 784-1000 Fax (201) 784-0111</p>	<p>Drawing Title: GTM91110P24024-CA-S, ITE / Medical Power Supply, Efficiency Level: N/A, Case Color/Style: PANTONE BLUE 072 UP or similar, Enclosed-Metal, Regulated Switchmode AC-DC Power Supply AC Adaptor, Input Rating: 100-240V~, 50-60 Hz, Molex Header (or equal) , Output Rating: 200W, 24.0V@8.33A, Output Configuration: N/A mm, N/A/6 Cond, , MOLEX 6-PIN FRICTION LOCK HEADER P/N 26-60-4060 MATES WITH PN: 09-50-3061, Ferrite: None, N/A, GT Cord # C1196, Pin Out: Pins 1,2,3: V+, Pins 4,5,6: Common, Blades/Input Cord: Not Applicable, Approvals: CE; SIQ; SIQ; WEEE; RoHS; China RoHS; Ukraine; FCC; VCCI; GOST-R; CB 60601-1; cETLus 60601-1 3rd; CE; CB 60950; Book 60601; Class I;</p>
	<p>Model No. GTM91110P24024-CA-S</p>
	<p>Part No./Ordering No. GTM91110P24024CAS(R) Rev F</p>

Optional Input Wiring Kits are available:

PN/Ordering No	Length	End A	End B
XHP410070M7MLX3(R)	70	JST XHP-4	Molex 09-93-0300
C810070M6MLX3(R)	60	IEC60320 C8	Molex 09-93-0300
C1410070M6MLX3(R)	60	IEC60320 C14	Molex 09-93-0300

Custom lengths, construction, cable types, ferrites, filters, and termination available upon request.

GlobTek, Inc. www.globtek.com 186 Veterans Drive, Northvale, NJ 07647 Tel. (201) 784-1000 Fax (201) 784-0111	Drawing Title: GTM91110P24024-CA-S, ITE / Medical Power Supply, Efficiency Level: N/A, Case Color/Style: PANTONE BLUE 072 UP or similar, Enclosed-Metal, Regulated Switchmode AC-DC Power Supply AC Adaptor, Input Rating: 100-240V~, 50-60 Hz, Molex Header (or equal) , Output Rating: 200W, 24.0V@8.33A, Output Configuration: N/A mm, N/A/6 Cond, , MOLEX 6-PIN FRICTION LOCK HEADER P/N 26-60-4060 MATES WITH PN: 09-50-3061, Ferrite: None, N/A, GT Cord # C1196, Pin Out: Pins 1,2,3: V+, Pins 4,5,6: Common, Blades/Input Cord: Not Applicable, Approvals: CE; SIQ; SIQ; WEEE; RoHS; China RoHS; Ukraine; FCC; VCCI; GOST-R; CB 60601-1; cETLus 60601-1 3rd; CE; CB 60950; Book 60601; Class I;
	Model No. GTM91110P24024-CA-S Part No./Ordering No. GTM91110P24024CAS(R)

OUTPUT CORD AND CONNECTOR: MOLFC1196

ACTUAL CONNECTORS, OVERMOLDS, FERRITES MAY VARY SLIGHTLY FROM THE PICTURE BELOW

CABLE TYPE

CABLE LENGTH (mm)	N/A
CABLE TOLERANCE (mm)	N/A
WIRE GAUGE (AWG)	N/A
CONDUCTORS	6
HANK DIMENSION (mm)	N/A
CABLE / CONNECTOR OVERMOLD COLOR	N/A
FERRITE TYPE / DIMENSION	None
FERRITE # OF TURNS (Definition)	N/A
FERRITE DIMENSION FROM STRAIN RELIEF	N/A
FERRITE DIMENSION FROM PLUG	N/A
PLUG TYPE	MOLEX 6-PIN FRICTION LOCK HEADER P/N 26-60-4060 MATES WITH PN: 09-50-3061

OUTPUT CONNECTOR GENDER

OVERMOLDED

OVER MOLD ORIENTATION

CONNECTOR PIN OUT: Pins 1,2,3: V+, Pins 4,5,6: Common

ADDITIONAL REQUIREMENTS

Drawing: http://www.molex.com/pdm_docs/sd/022280040_sd.pdf

Datasheet: http://www.molex.com/molex/products/datasheet.jsp?part=active/0022280040_PCB_HEADERS.xml

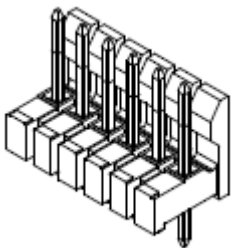

[Mates With Part\(s\):](#)

[KK® Crimp Housing 2695, 6471, 7880](#), [KK® PC Board Connector 4455](#)

ADDITIONAL OUTPUT PLUG OPTIONS ARE AVAILABLE AT <https://www.globtek.com/connectors/>

STANDARD PLUGS AND CONNECTORS CAN BE SEEN ONLINE AT <https://www.globtek.com/connectors/>

CALCULATE VOLTAGE REGULATION/DROP WITH OUR ONLINE CALCULATOR: <https://en.globtek.com/output-cable-regulation-calculator/>

PROPRIETARY INFORMATION

PROPRIETARY OF GLOBTEK, INC. ANY REPRODUCTION, DISCLOSURE OR USE OF THIS DRAWING, IN WHOLE OR IN PART, IS HEREBY PROHIBITED EXCEPT AS SPECIFIED IN Page 11 of 16

WRITING BY GLOBTEK, INC. © GlobTek, Inc. 2012 - 2020

quest /08/14/2020 8:33:18 AM

<p>GlobTek, Inc. www.globtek.com 186 Veterans Drive, Northvale, NJ 07647 Tel. (201) 784-1000 Fax (201) 784-0111</p>	<p>Drawing Title: GTM91110P24024-CA-S, ITE / Medical Power Supply, Efficiency Level: N/A, Case Color/Style: PANTONE BLUE 072 UP or similar, Enclosed-Metal, Regulated Switchmode AC-DC Power Supply AC Adaptor, Input Rating: 100-240V~, 50-60 Hz, Molex Header (or equal) , Output Rating: 200W, 24.0V@8.33A, Output Configuration: N/A mm, N/A/6 Cond, , MOLEX 6-PIN FRICTION LOCK HEADER P/N 26-60-4060 MATES WITH PN: 09-50-3061, Ferrite: None, N/A, GT Cord # C1196, Pin Out: Pins 1,2,3: V+, Pins 4,5,6: Common, Blades/Input Cord: Not Applicable, Approvals: CE; SIQ; SIQ; WEEE; RoHS; China RoHS; Ukraine; FCC; VCCI; GOST-R; CB 60601-1; cETLus 60601-1 3rd; CE; CB 60950; Book 60601; Class I;</p>
	<p>Model No. GTM91110P24024-CA-S</p>
	<p>Part No./Ordering No. GTM91110P24024CAS(R) Rev F</p>

OUTPUT CONNECTOR HOOK UP

TO ADDRESS SYSTEM-LEVEL EMI CONCERNS, FERRITE CHOKES/BEADS MAY BE ADDED/REVISED UPON REQUEST. A SAMPLE KIT OF GLOBTEK'S STANDARD FERRITES IS AVAILABLE UNDER GLOBTEK P/N: EMI-MITIGATION-KIT1

FOR ADDITIONAL INFORMATION, PLEASE READ OUR WHITE PAPER AT:

<https://en.globtek.com/technical-articles/ferrite-kit-radiated-emi-suppression-kit-for-globtek-power-supplies-cable-assemblies>

GlobTek, Inc. www.globtek.com 186 Veterans Drive, Northvale, NJ 07647 Tel. (201) 784-1000 Fax (201) 784-0111	Drawing Title: GTM91110P24024-CA-S, ITE / Medical Power Supply, Efficiency Level: N/A, Case Color/Style: PANTONE BLUE 072 UP or similar, Enclosed-Metal, Regulated Switchmode AC-DC Power Supply AC Adaptor, Input Rating: 100-240V~, 50-60 Hz, Molex Header (or equal) , Output Rating: 200W, 24.0V@8.33A, Output Configuration: N/A mm, N/A/6 Cond, , MOLEX 6-PIN FRICTION LOCK HEADER P/N 26-60-4060 MATES WITH PN: 09-50-3061, Ferrite: None, N/A, GT Cord # C1196, Pin Out: Pins 1,2,3: V+, Pins 4,5,6: Common, Blades/Input Cord: Not Applicable, Approvals: CE; SIQ; SIQ; WEEE; RoHS; China RoHS; Ukraine; FCC; VCCI; GOST-R; CB 60601-1; cETLus 60601-1 3rd; CE; CB 60950; Book 60601; Class I;
	Model No. GTM91110P24024-CA-S Part No./Ordering No. GTM91110P24024CAS(R)

LABEL:L-1186

LABEL P/N:	Standard GT
MATERIAL:	Flat Thermal Transfer, Imprintable, Polyester Label and/or Pad Printed and/or Molded, and/or Laser Engraved in the case
BACKGROUND COLOR:	Black if housing is Black, White or Silver if housing is White or Gray.
TEXT COLOR:	White or Silver if label is Black Background for Black housing. Black if label is White or Silver background and Housing is White or Gray.
LABEL WIDTH (mm):	50.0
LABEL HEIGHT (mm):	50.0
SPECIAL BARCODE LABEL MATERIAL:	

Below is the minimum information which will appear on the label. NOTE: in the logo area additional/actual positioning of symbols and text is subjected to change as per agency updates/requirements or additional model approvals become available. Regulatory certifications/label markings may be in logo area on the label or molded into the case housing outside the label area. Information will be shown via label and/or pad printed and/or molded and/or laser engraved in the case. * Date code markings at GlobTek option

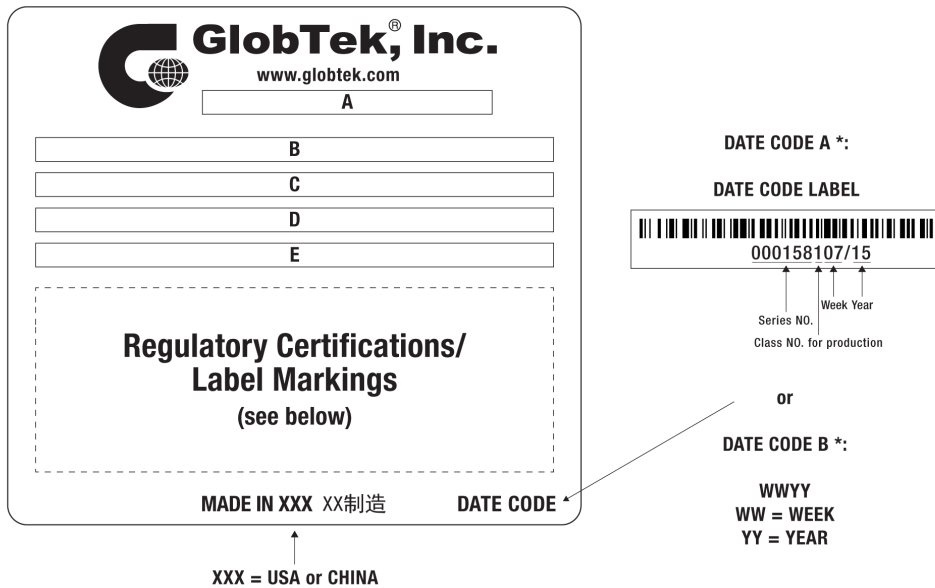

A=ITE / Medical Power Supply
 B=P/N: (料号) GTM91110P24024CAS(R)
 C=Model (型号) GTM91110P24024-CA-S
 D=Input (输入)100-240V~, 50-60 Hz, 4.0A
 E=Output (输出)24.0 V --- 8.33 A, 200.0W

GlobTek, Inc. www.globtek.com 186 Veterans Drive, Northvale, NJ 07647 Tel. (201) 784-1000 Fax (201) 784-0111	Drawing Title: GTM91110P24024-CA-S, ITE / Medical Power Supply, Efficiency Level: N/A, Case Color/Style: PANTONE BLUE 072 UP or similar, Enclosed-Metal, Regulated Switchmode AC-DC Power Supply AC Adaptor, Input Rating: 100-240V~, 50-60 Hz, Molex Header (or equal) , Output Rating: 200W, 24.0V@8.33A, Output Configuration: N/A mm, N/A/6 Cond, , MOLEX 6-PIN FRICTION LOCK HEADER P/N 26-60-4060 MATES WITH PN: 09-50-3061, Ferrite: None, N/A, GT Cord # C1196, Pin Out: Pins 1,2,3: V+, Pins 4,5,6: Common, Blades/Input Cord: Not Applicable, Approvals: CE; SIQ; SIQ; WEEE; RoHS; China RoHS; Ukraine; FCC; VCCI; GOST-R; CB 60601-1; cETLus 60601-1 3rd; CE; CB 60950; Book 60601; Class I;	
	Model No. GTM91110P24024-CA-S Part No./Ordering No. GTM91110P24024CAS(R)	Rev F

AGENCY ONLINE DOCUMENTS

<http://www.globtek.info/certs/GTM91110P/>

CE EC-Declaration for Medical

http://globtek.force.com/models/ec_declaration_product?id=01t30000002pMxZ&m=1

CE EC-Declaration for Industrial/Commercial/ITE

http://globtek.force.com/models/ec_declaration_product?id=01t30000002pMxZ&i=4

CE EC-Declaration for Household

[Contact GlobTek for more information](#)

Morocco SDoC Declaration

https://globtek.secure.force.com/models/Morocco_SDoC_Declaration?id=a0Oa000000MgWUbeAN

RoHS/RoHS3 Declaration

https://www.globtek.com/pdf/rohs_cert/01t30000002pMxZAAU

REACH Declaration

https://www.globtek.com/pdf/iso_certificates/REACH.pdf

Conflict Minerals Declaration

<https://www.globtek.com/pdf/conflict-minerals.pdf>

IPXY rating is based on 3rd party testing and customers should check suitability and test system level IPXY rating before ordering.

Regulatory Certifications/Label Markings

LATEST PRODUCT/MODEL CERTIFICATIONS: <http://en.globtek.com/datasheet/id/a0Oa000000MgWUbe>

AGENCY ONLINE DOCUMENTS:

<http://www.globtek.info/certs/GTM91110P/>



(F1) Class II / Double Insulated



1 6 Pins 1,2,3: V+, Pins 4,5,6: Common

OUTPUT CONNECTOR

GlobTek, Inc. www.globtek.com 186 Veterans Drive, Northvale, NJ 07647 Tel. (201) 784-1000 Fax (201) 784-0111	Drawing Title: GTM91110P24024-CA-S, ITE / Medical Power Supply, Efficiency Level: N/A, Case Color/Style: PANTONE BLUE 072 UP or similar, Enclosed-Metal, Regulated Switchmode AC-DC Power Supply AC Adaptor, Input Rating: 100-240V~, 50-60 Hz, Molex Header (or equal) , Output Rating: 200W, 24.0V@8.33A, Output Configuration: N/A mm, N/A/6 Cond, , MOLEX 6-PIN FRICTION LOCK HEADER P/N 26-60-4060 MATES WITH PN: 09-50-3061, Ferrite: None, N/A, GT Cord # C1196, Pin Out: Pins 1,2,3: V+, Pins 4,5,6: Common, Blades/Input Cord: Not Applicable, Approvals: CE; SIQ; SIQ; WEEE; RoHS; China RoHS; Ukraine; FCC; VCCI; GOST-R; CB 60601-1; cETLus 60601-1 3rd; CE; CB 60950; Book 60601; Class I;
	Model No. GTM91110P24024-CA-S Part No./Ordering No. GTM91110P24024CAS(R)

PACKAGING

Packing Spec P/N:

Box Qty:	36
Gift Box Size (mm):	160*67*90
Gift Box Color:	White
Master Carton Size (mm):	430 x 340 x 304
Master Carton Cubic Volume (m³):	0.04
Master GW (Kg):	14.0 kg
BLADES INCLUDED:	:
BLADE/CORD INSTALLED:	:
USER MANUAL*:	
USER MANUAL WEB LINK:	

* This specification sheet is considered the user manual for all applications. It is expected that the buyer of this product will use it to formulate their own user manual for their end product and a user manual specifically for the power adapter is not usually required. If a user manual is not specifically listed above then none will be provided with this unit.

<p>GlobTek, Inc. www.globtek.com 186 Veterans Drive, Northvale, NJ 07647 Tel. (201) 784-1000 Fax (201) 784-0111</p>	<p>Drawing Title: GTM91110P24024-CA-S, ITE / Medical Power Supply, Efficiency Level: N/A, Case Color/Style: PANTONE BLUE 072 UP or similar, Enclosed-Metal, Regulated Switchmode AC-DC Power Supply AC Adaptor, Input Rating: 100-240V~, 50-60 Hz, Molex Header (or equal) , Output Rating: 200W, 24.0V@8.33A, Output Configuration: N/A mm, N/A/6 Cond, , MOLEX 6-PIN FRICTION LOCK HEADER P/N 26-60-4060 MATES WITH PN: 09-50-3061, Ferrite: None, N/A, GT Cord # C1196, Pin Out: Pins 1,2,3: V+, Pins 4,5,6: Common, Blades/Input Cord: Not Applicable, Approvals: CE; SIQ; SIQ; WEEE; RoHS; China RoHS; Ukraine; FCC; VCCI; GOST-R; CB 60601-1; cETLus 60601-1 3rd; CE; CB 60950; Book 60601; Class I;</p>
	<p>Model No. GTM91110P24024-CA-S</p>
	<p>Part No./Ordering No. GTM91110P24024CAS(R) Rev F</p>

INSTRUCTIONS TO THE OEM SYSTEMS ENGINEER

It is the responsibility of the OEM systems engineer to provide the end system user instructions and warnings for the use of this product in the end system.

If an input cord is required for this product, AC Mains voltage should be provided to the power supply by a power supply cord approved to the national standards of the country in which it will be used.

This power supply is not designed to be repaired. No serviceable parts inside. A blown internal fuse is an indication of catastrophic failure of circuit component(s). If a Failure Analysis is required for a failed power supply/battery charger, please return the damaged unit to Globtek for an accurate determination of the root cause of the failure.

EMC Compliance of the complete OEM product, including the GlobTek power supply/battery charger needs to be verified by the OEM systems engineer.

INSTRUCTION SHEET

Notes for GT(M)91110P240VV-ZA(W)-S

1. MEDICAL VERSION IS DESIGNED NOT TO BE USED IN SYSTEMS WITH DIRECT PATIENT CONTACT.
2. ALL MEASUREMENTS ARE MADE DIRECTLY AT THE TERMINALS OF THE SUPPLY.
3. OUTPUT RIPPLE AND SPIKE ARE MEASURED DIRECTLY AT THE OUTPUT TERMINALS OF THE POWER SUPPLY WITH 10µF TANTALUM AND 0.1µF CERAMIC CAPACITORS CONNECTED IN PARALLEL. PEAK-TO-PEAK METERING EQUIPMENT MUST HAVE A 20 MHz FREQUENCY RESPONSE WITH PROBES AND CABLES THAT MAINTAIN A FREQUENCY RESPONSE OF 20Hz TO 20MHz.
4. CONDUCTED AND RADIATED EMI WERE PERFORMED WITH RESISTIVE LOAD SET TO FULL LOAD. PSU AND RESISTIVE LOAD WERE MOUNTED TOGETHER IN AN ALUMINUM PLATE.
5. REMOTE SENSE WIRE SHOULD BE TWISTED TOGETHER WHEN USED.
6. ALL MEASUREMENTS ARE MADE AT 25°C AMBIENT TEMPERATURE AND ARE TYPICAL.
7. WHEN LONG INPUT AND/OR OUTPUT WIRE HARNESS IS USED, ADDITIONAL EMI FILTERING MAY BE NECESSARY. FERRITE CORE MAY BE ADDED TO THE WIRE HARNESS AS REQUIRED.
8. FOR DC INPUT, END USER MUST PROVIDE DC RATED FUSE ON THE V+ SIDE OF THE INPUT VOLTAGE. FUSE RATING IS 3A 350VDC.
- 9 IN COMPLIANCE TO IEC 60601-1 REQUIREMENT, A WARNING NOTICE IS ADDED. "WARNING: NO MODIFICATION TO THIS EQUIPMENT IS ALLOWED".
10. WARNING STATEMENT FOR CLASS I VERSION: "WARNING: TO AVOID RISK OF ELECTRIC SHOCK, THIS EQUIPMENT MUST ONLY BE CONNECTED TO A SUPPLY MAINS WITH PROTECTIVE EARTH".
11. GLOBTEK PRODUCTS ARE NOT AUTHORIZED TO BE USED AS MISSION CRITICAL COMPONENTS WITHOUT PRIOR WRITTEN APPROVAL FROM THE CEO OF GLOBTEK INC.
12. OTHER BRANDS OF SIMILAR SPECS MAY BE USED FOR INPUT AND OUTPUT CONNECTORS.
13. SPECIFICATIONS ARE SUBJECT TO CHANGE WITHOUT PRIOR NOTICE.

PROPRIETARY INFORMATION

PROPRIETARY OF GLOBTEK, INC. ANY REPRODUCTION, DISCLOSURE OR USE OF THIS DRAWING, IN WHOLE OR IN PART, IS HEREBY PROHIBITED EXCEPT AS SPECIFIED IN Page 16 of 16

WRITING BY GLOBTEK, INC. © GlobTek, Inc. 2012 - 2020

quest /08/14/2020 8:33:18 AM