

GloTek, Inc. www.globtek.com 186 Veterans Drive, Northvale, NJ 07647 Tel. (201) 784-1000 Fax (201) 784-0111	Drawing Title: GT-46600-6024-T2, ICT/ITE Power Supply, Efficiency Level: USA DOE Level VI / Eco-design Directive 2009/125/EC, (EU) 2019/1782, Case Color/Style: GlobTek Black, Desktop/External, Regulated Switchmode AC-DC Power Supply AC Adaptor, Input Rating: 100-240V~, 50-60 Hz, IEC 60320/C8 , Output Rating: 60W, 24.0V@2.5A, Output Configuration: 1530 mm, 18/2 Cond, UL 2468, Female Barrel 5.5 * 2.5 * 11mm with internal Spring Clip and Locking Notch or Equal, Ferrite: Core Size: 14.2*28.5*8.2, GlobTek Black, GT Cord # C2285, Pin Out: Center Positive (+V), Blades/Input Cord: Not Applicable, Approvals: 230V CoC Tier 2; Saudi; CB 60335; EAC; CB 60950; UKCA; Malaysia; cULus; NrCAN (12V and 15V); Morocco; CB 62368; FCC; cULus; CE; CE; China RoHS; Double Insulation; Level VI; LPS 60950; PSE; RoHS; Ukraine; VCCI; WEEE; CCC; PSE; RCM;	
	Model No. GT-46600-6024-T2	
	Part No./Ordering No. TR9KI2500LCP-N(R6B)	Rev B

REVISION HISTORY

REV	DESCRIPTION	SUB	DATE	APPROVED
B	Update wire gauge from 16AWG to 18AWG		11/13/2017	QA
A	Initial release		08/25/2017	QA

In Addition to GlobTek Inc.'s renewed ISO9001:2015 - Quality Management System Certification, GlobTek Inc. is now certified to:

ISO13485:2016 - Medical Devices Quality Management System Certification

ISO14001:2015 - Environmental Management System Certification

ISO Certificates are available online at <https://www.globtek.com/iso-certificates/>

Customer Approval of Specification:

Please approve, sign and send back to GlobTek so we can complete order processing.

A delay in receipt of this form will delay delivery schedule.

Company Name:

Customer P/N:

Quote Number:

Date:

Authorized Representative Name:

Authorized Representative Signature:

The acceptance of this specification and use of the product described in this document indicates the acceptance and binding of the customer to Globtek terms and conditions, which supersede all other agreements, terms, and conditions (<https://en.globtek.com/terms-and-conditions/>).

The purchaser of this product (Customer) agrees that it is their sole responsibility to determine suitability/fitness of the product described in this specification for their application and to take precautions for protection against any hazards attendant to the handling and use of the product.

Footnote:

GlobTek Inc. will not be liable for the safety and performance of these power supplies if unauthorized access and repair occurs. End user should consult applicable UL, CSA or EN standards for proper installation instruction.

Limitation of Use:

GlobTek products are intended for use with commercial, medical, and/or industrial equipment only. GlobTek product are not authorized for use as mission critical components in life support hazardous environment, nuclear or aircraft applications without prior written approval from the CEO of GlobTek Inc.

Contents of this document are subject to change without prior notice.

GlobTek, Inc. www.globtek.com 186 Veterans Drive, Northvale, NJ 07647 Tel. (201) 784-1000 Fax (201) 784-0111	Drawing Title: GT-46600-6024-T2, ICT/ITE Power Supply, Efficiency Level: USA DOE Level VI / Eco-design Directive 2009/125/EC, (EU) 2019/1782, Case Color/Style: GlobTek Black, Desktop/External, Regulated Switchmode AC-DC Power Supply AC Adaptor, Input Rating: 100-240V~, 50-60 Hz, IEC 60320/C8 , Output Rating: 60W, 24.0V@2.5A, Output Configuration: 1530 mm, 18/2 Cond, UL 2468, Female Barrel 5.5 * 2.5 * 11mm with internal Spring Clip and Locking Notch or Equal, Ferrite: Core Size: 14.2*28.5*8.2, GlobTek Black, GT Cord # C2285, Pin Out: Center Positive (+V), Blades/Input Cord: Not Applicable, Approvals: 230V CoC Tier 2; Saudi; CB 60335; EAC; CB 60950; UKCA; Malaysia; cULus; NrCAN (12V and 15V); Morocco; CB 62368; FCC; cULus; CE; CE; China RoHS; Double Insulation; Level VI; LPS 60950; PSE; RoHS; Ukraine; VCCI; WEEE; CCC; PSE; RCM;	
	Model No. GT-46600-6024-T2	
	Part No./Ordering No. TR9KI2500LCP-N(R6B)	Rev B

POWER SUPPLY INFORMATION

TYPE:	Desktop/External
TECHNOLOGY:	Regulated Switchmode AC-DC Power Supply AC Adaptor
CASE COLOR:	GlobTek Black
NAMEPLATE RATED INPUT:	100-240V~, 50-60 Hz, 1.5A
INPUT CONFIG:	IEC 60320/C8
WATTS:	60.0
VOLTS OUT:	24.0
CURRENT OUT (Amps):	2.5
BLADE/CORD INCLUDED:	N/A Not Applicable
BLADE/CORD INSTALLED:	N/A :Not Applicable
INGRESS PROTECTION:	IPX0
GROUNDING CONFIGURATION:	(F1) Class II / Double Insulated
EFFICIENCY LEVEL:	USA DOE Level VI / Eco-design Directive 2009/125/EC, (EU) 2019/1782
OUTPUT CONFIGURATION:	1530 mm, 18/2 Cond, UL 2468, Female Barrel 5.5 * 2.5 * 11mm with internal Spring Clip and Locking Notch or Equal, Ferrite: Core Size: 14.2*28.5*8.2, GlobTek Black, GT Cord # C2285
CONNECTOR PIN OUT:	Center Positive (+V)
LABEL SPECS:	Standard GT,L-1186
SPECIAL BARCODE LABEL MATERIAL:	No
PACK SPEC:	PACKING FOR GT-46600, User manual
USER MANUAL:	809-DESKTOPUSERMANUAL on A4 paper

PROPRIETARY INFORMATION

PROPRIETARY OF GLOBTEK, INC. ANY REPRODUCTION, DISCLOSURE OR USE OF THIS DRAWING, IN WHOLE OR IN PART, IS HEREBY PROHIBITED EXCEPT AS SPECIFIED IN WRITING BY GLOBTEK, INC. © GlobTek, Inc. 2015 - 2021

GlobTek, Inc. www.globtek.com 186 Veterans Drive, Northvale, NJ 07647 Tel. (201) 784-1000 Fax (201) 784-0111	Drawing Title: GT-46600-6024-T2, ICT/ITE Power Supply, Efficiency Level: USA DOE Level VI / Eco-design Directive 2009/125/EC, (EU) 2019/1782, Case Color/Style: GlobTek Black, Desktop/External, Regulated Switchmode AC-DC Power Supply AC Adaptor, Input Rating: 100-240V~, 50-60 Hz, IEC 60320/C8 , Output Rating: 60W, 24.0V@2.5A, Output Configuration: 1530 mm, 18/2 Cond, UL 2468, Female Barrel 5.5 * 2.5 * 11mm with internal Spring Clip and Locking Notch or Equal, Ferrite: Core Size: 14.2*28.5*8.2, GlobTek Black, GT Cord # C2285, Pin Out: Center Positive (+V), Blades/Input Cord: Not Applicable, Approvals: 230V CoC Tier 2; Saudi; CB 60335; EAC; CB 60950; UKCA; Malaysia; cULus; NrCAN (12V and 15V); Morocco; CB 62368; FCC; cULus; CE; CE; China RoHS; Double Insulation; Level VI; LPS 60950; PSE; RoHS; Ukraine; VCCI; WEEE; CCC; PSE; RCM;	
	Model No. GT-46600-6024-T2	
	Part No./Ordering No. TR9KI2500LCP-N(R6B)	Rev B

Notes/Modifications/Customizations (notes in this section supersede the values shown in the standard spec):
DIMENSIONS ARE IN MM UNLESS SPECIFIED OTHERWISE.

GloBtek, Inc. www.globtek.com 186 Veterans Drive, Northvale, NJ 07647 Tel. (201) 784-1000 Fax (201) 784-0111	Drawing Title: GT-46600-6024-T2, ICT/ITE Power Supply, Efficiency Level: USA DOE Level VI / Eco-design Directive 2009/125/EC, (EU) 2019/1782, Case Color/Style: GlobTek Black, Desktop/External, Regulated Switchmode AC-DC Power Supply AC Adaptor, Input Rating: 100-240V~, 50-60 Hz, IEC 60320/C8, Output Rating: 60W, 24.0V@2.5A, Output Configuration: 1530 mm, 18/2 Cond, UL 2468, Female Barrel 5.5 * 2.5 * 11mm with internal Spring Clip and Locking Notch or Equal, Ferrite: Core Size: 14.2*28.5*8.2, GlobTek Black, GT Cord # C2285, Pin Out: Center Positive (+V), Blades/Input Cord: Not Applicable, Approvals: 230V CoC Tier 2; Saudi; CB 60335; EAC; CB 60950; UKCA; Malaysia; cULus; NrCAN (12V and 15V); Morocco; CB 62368; FCC; cULus; CE; CE; China RoHS; Double Insulation; Level VI; LPS 60950; PSE; RoHS; Ukraine; VCCI; WEEE; CCC; PSE; RCM;	
	Model No. GT-46600-6024-T2	
	Part No./Ordering No. TR9KI2500LCP-N(R6B)	Rev B

ELECTRICAL SPECIFICATIONS

A) ELECTRICAL SPECIFICATIONS:

01. Input Voltage: Specified 90-264 Vac, Nameplate rated: 100-240Vac
02. Input Frequency: Specified 47-63 Hz, Nameplate rated 50-60Hz
03. Input Rated Current: 1.5A RMS Max
04. Inrush Current: No damage at 240VAC Cold Start
05. Average Efficiency: 88% Min (CEC & DOE LEVEL VI Compliant); 89% Min (ErP Tier2 Compliant)
06. Input Power(no load): <0.21W (CEC &DOE Level VI Compliant); <0.15W (ErP Tier2 Compliant)
07. Line regulation: $\pm 1\%$
08. Ripple Voltage: 200mV (p-p) (100-240V AC Input). Measuring is done by 20MHz bandwidth oscilloscope and terminated each output with a 10uf aluminum electrolytic capacitor and 0.1uf ceramic capacitor.

B) PROTECTION

01. Over-Voltage: Electronically Protected Zener clamp across the output
02. Short Circuit: Electronically Protected unit will auto recover upon removal of fault
03. Over Temperature Protection: There shall be no ignition or smoke and deformation of case
04. 08. Over voltage protection: for 12V - 16V; for 15V - 20.25V, for 19V - 25.65, for 24V - 32.4V

C) SAFETY

01. Dielectric Withstand Voltage: 4242Vdc from primary to secondary
02. Touch Current: <0.25mA @ 240Vac input voltage
03. ROHS 2: Complies with EU 2011/65/EU and China SJ/T 11363-2006

D) OTHER:

01. MTBF: 1,500,000 hours @ 25°C ambient, full load (Telcordia SR-332, Issue 3)
02. Operating Temperature: 0°C to 40°C ambient temperature
03. Humidity: 10% to 90% relative humidity
04. Storage Temperature: -10°C to 70°C
05. Cooling: Convection
06. ROHS 2: Complies with EU 2011/65/EU and China SJ/T 11363-2006

E) ENCLOSURE

01. Housing: High impact plastic, 94V0 polycarbonate, non-vented
02. Size: 121*52*33 +/-1.0 mm
03. Markings: Label and/or Pad Printed and/or Molded in the case

TO ADDRESS SYSTEM-LEVEL EMI CONCERNS, FERRITE CHOKES/BEADS MAY BE ADDED/REVISED UPON REQUEST. A SAMPLE KIT OF GLOBTEK'S STANDARD FERRITES IS AVAILABLE UNDER GLOBTEK P/N: EMI-MITIGATION-KIT1

FOR ADDITIONAL INFORMATION, PLEASE READ OUR WHITE PAPER AT:

<https://en.globtek.com/technical-articles/ferrite-kit-radiated-emi-suppression-kit-for-globtek-power-supplies-cable-assemblies>

INGRESS PROTECTION: IPX0

PROPRIETARY INFORMATION

PROPRIETARY OF GLOBTEK, INC. ANY REPRODUCTION, DISCLOSURE OR USE OF THIS DRAWING, IN WHOLE OR IN PART, IS HEREBY PROHIBITED EXCEPT AS SPECIFIED IN WRITING BY GLOBTEK, INC. © GlobTek, Inc. 2015 - 2021

quest/06/14/2021 12:47:02 AM CLONED FROM TR9CE5000LCP-N(R6B)

GlobTek, Inc.
 www.globtek.com
 186 Veterans Drive,
 Northvale, NJ 07647
 Tel. (201) 784-1000
 Fax (201) 784-0111

Drawing Title: GT-46600-6024-T2, ICT/ITE Power Supply, Efficiency Level: USA DOE Level VI / Eco-design Directive 2009/125/EC, (EU) 2019/1782, Case Color/Style: GlobTek Black, Desktop/External, Regulated Switchmode AC-DC Power Supply AC Adaptor, Input Rating: 100-240V~, 50-60 Hz, IEC 60320/C8, Output Rating: 60W, 24.0V@2.5A, Output Configuration: 1530 mm, 18/2 Cond, UL 2468, Female Barrel 5.5 * 2.5 * 11mm with internal Spring Clip and Locking Notch or Equal, Ferrite: Core Size: 14.2*28.5*8.2, GlobTek Black, GT Cord # C2285, Pin Out: Center Positive (+V), Blades/Input Cord: Not Applicable, Approvals: 230V CoC Tier 2; Saudi; CB 60335; EAC; CB 60950; UKCA; Malaysia; cULus; NrCAN (12V and 15V); Morocco; CB 62368; FCC; cULus; CE; CE; China RoHS; Double Insulation; Level VI; LPS 60950; PSE; RoHS; Ukraine; VCCI; WEEE; CCC; PSE; RCM;

Model No. GT-46600-6024-T2

Part No./Ordering No. TR9KI2500LCP-N(R6B)

Rev B

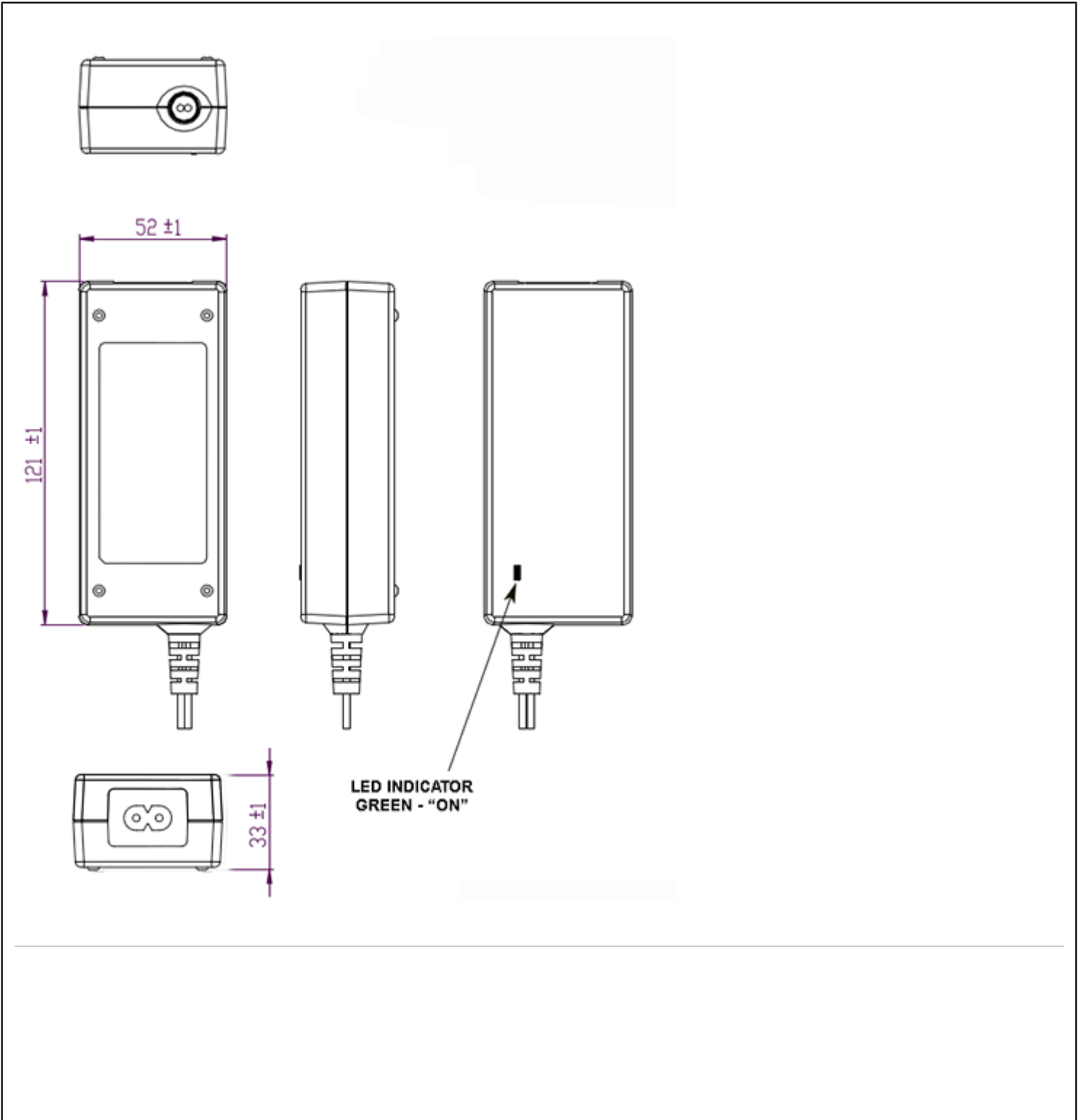

PROPRIETARY INFORMATION

PROPRIETARY OF GLOBTEK, INC. ANY REPRODUCTION, DISCLOSURE OR USE OF THIS DRAWING, IN WHOLE OR IN PART, IS HEREBY PROHIBITED EXCEPT AS SPECIFIED IN WRITING BY GLOBTEK, INC. © GlobTek, Inc. 2015 - 2021

<p>GlobTek, Inc. www.globtek.com 186 Veterans Drive, Northvale, NJ 07647 Tel. (201) 784-1000 Fax (201) 784-0111</p>	<p>Drawing Title: GT-46600-6024-T2, ICT/ITE Power Supply, Efficiency Level: USA DOE Level VI / Eco-design Directive 2009/125/EC, (EU) 2019/1782, Case Color/Style: GlobTek Black, Desktop/External, Regulated Switchmode AC-DC Power Supply AC Adaptor, Input Rating: 100-240V~, 50-60 Hz, IEC 60320/C8 , Output Rating: 60W, 24.0V@2.5A, Output Configuration: 1530 mm, 18/2 Cond, UL 2468, Female Barrel 5.5 * 2.5 * 11mm with internal Spring Clip and Locking Notch or Equal, Ferrite: Core Size: 14.2*28.5*8.2, GlobTek Black, GT Cord # C2285, Pin Out: Center Positive (+V), Blades/Input Cord: Not Applicable, Approvals: 230V CoC Tier 2; Saudi; CB 60335; EAC; CB 60950; UKCA; Malaysia; cULus; NrCAN (12V and 15V); Morocco; CB 62368; FCC; cULus; CE; CE; China RoHS; Double Insulation; Level VI; LPS 60950; PSE; RoHS; Ukraine; VCCI; WEEE; CCC; PSE; RCM;</p> <p>Model No. GT-46600-6024-T2</p> <p>Part No./Ordering No. TR9KI2500LCP-N(R6B)</p>	<p>Rev B</p>
--	---	--------------

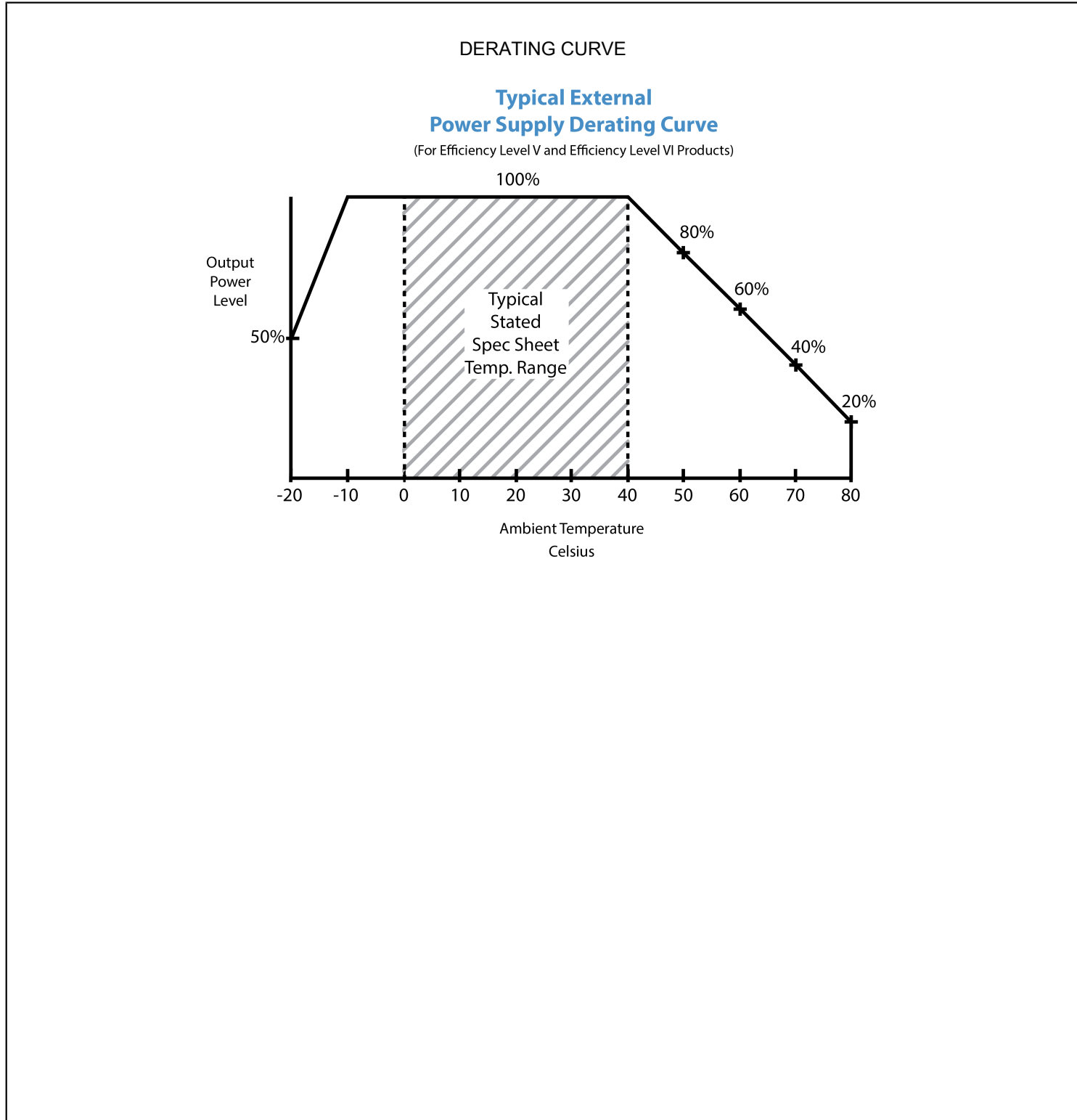

GlobTek, Inc. www.globtek.com 186 Veterans Drive, Northvale, NJ 07647 Tel. (201) 784-1000 Fax (201) 784-0111	Drawing Title: GT-46600-6024-T2, ICT/ITE Power Supply, Efficiency Level: USA DOE Level VI / Eco-design Directive 2009/125/EC, (EU) 2019/1782, Case Color/Style: GlobTek Black, Desktop/External, Regulated Switchmode AC-DC Power Supply AC Adaptor, Input Rating: 100-240V~, 50-60 Hz, IEC 60320/C8, Output Rating: 60W, 24.0V@2.5A, Output Configuration: 1530 mm, 18/2 Cond, UL 2468, Female Barrel 5.5 * 2.5 * 11mm with internal Spring Clip and Locking Notch or Equal, Ferrite: Core Size: 14.2*28.5*8.2, GlobTek Black, GT Cord # C2285, Pin Out: Center Positive (+V), Blades/Input Cord: Not Applicable, Approvals: 230V CoC Tier 2; Saudi; CB 60335; EAC; CB 60950; UKCA; Malaysia; cULus; NrCAN (12V and 15V); Morocco; CB 62368; FCC; cULus; CE; CE; China RoHS; Double Insulation; Level VI; LPS 60950; PSE; RoHS; Ukraine; VCCI; WEEE; CCC; PSE; RCM;	
	Model No. GT-46600-6024-T2	
	Part No./Ordering No. TR9KI2500LCP-N(R6B)	Rev B

INPUT CONFIGURATION

(F1) Class II / Double Insulated

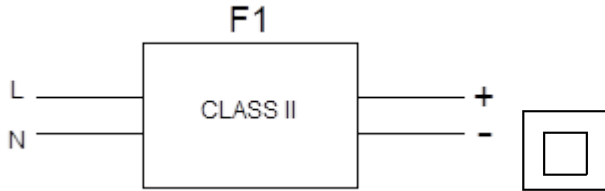

[Alternate grounding configurations](#) available upon request.

Blades/Cord Included:N/A:Not Applicable

Blades/Cord Installed:N/A:Not Applicable

IEC 60320/C8 AC Inlet connector, Class II, Non-Earth Ground (aka "Figure-8")

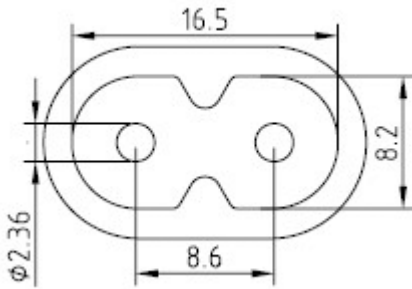

Mates with IEC 60320/C7 Plug

Below are standard cordsets which are "not included" (unless stated above); these may be purchased separately or packaged with the power supply. Please contact your Sales Engineer if the style required is not shown below. Many more available in different lengths, colors or cable material.

[Standard International IEC 320/C7 Cordsets](#)

Part Number	Type	Standard	Connector	Length (mm)	Length (feet)
2094112M703(R)	Argentina (Type I)	IRAM 2063	IEC 320/C7	2000	7
5014112M703A(R)	Australian (Type I)	AS 3112	IEC 320/C7	2000	7
207B4111M8703(R)	Brazil (Type N)	NBR14136	IEC 320/C7	1800	6

PROPRIETARY INFORMATION

PROPRIETARY OF GLOBTEK, INC. ANY REPRODUCTION, DISCLOSURE OR USE OF THIS DRAWING, IN WHOLE OR IN PART, IS HEREBY PROHIBITED EXCEPT AS SPECIFIED IN

WRITING BY GLOBTEK, INC. © GlobTek, Inc. 2015 - 2021

quest /06/14/2021 12:47:02 AM CLONED FROM TR9CE5000LCP-N(R6B)

GlobTek, Inc. www.globtek.com 186 Veterans Drive, Northvale, NJ 07647 Tel. (201) 784-1000 Fax (201) 784-0111	Drawing Title: GT-46600-6024-T2, ICT/ITE Power Supply, Efficiency Level: USA DOE Level VI / Eco-design Directive 2009/125/EC, (EU) 2019/1782, Case Color/Style: GlobTek Black, Desktop/External, Regulated Switchmode AC-DC Power Supply AC Adaptor, Input Rating: 100-240V~, 50-60 Hz, IEC 60320/C8, Output Rating: 60W, 24.0V@2.5A, Output Configuration: 1530 mm, 18/2 Cond, UL 2468, Female Barrel 5.5 * 2.5 * 11mm with internal Spring Clip and Locking Notch or Equal, Ferrite: Core Size: 14.2*28.5*8.2, GlobTek Black, GT Cord # C2285, Pin Out: Center Positive (+V), Blades/Input Cord: Not Applicable, Approvals: 230V CoC Tier 2; Saudi; CB 60335; EAC; CB 60950; UKCA; Malaysia; cULus; NrCAN (12V and 15V); Morocco; CB 62368; FCC; cULus; CE; CE; China RoHS; Double Insulation; Level VI; LPS 60950; PSE; RoHS; Ukraine; VCCI; WEEE; CCC; PSE; RCM;	
	Model No. GT-46600-6024-T2	
	Part No./Ordering No. TR9KI2500LCP-N(R6B)	Rev B

4533501M8703(R)	China (Type A)	GB 2099.1	IEC 320/C7	1830	6
2074112M703A(R)	European (Type C)	CEE 7/16	IEC 320/C7	2000	7
2084111M8703B(R)	India (Type D)	IS 1293	IEC 320/C7	1800	6
451J3401M8703(R)	Japan (Type A)	JIS 8303	IEC 320/C7	1830	6
2044112M703A(R)	Korea (Type C)	KS C8305	IEC 320/C7	2000	7
4511116F703A(R)	North America (Type A)	NEMA 1-15P	IEC 320/C7	1830	6
2084111M8703(R)	South Africa (Type M)	BS 546	IEC320/C7	1830	6
4033401M8703A(R)	Taiwan (Type A)	CNS690	IEC 320/C7	1830	6
6104112M703A(R)	UK, Hong Kong, Singapore, Gulf States (Type G)	BS1363	IEC 320/C7	2000	7
451G1116F703A(R)	Gulf States (Kuwait, Bahrain, Oman, Qatar, Saudi Arabia, Yemen and the United Arab Emirates (UAE)(Type A)	Nema 1-15P	IEC320/C7	1830	6

GlobTek, Inc. www.globtek.com 186 Veterans Drive, Northvale, NJ 07647 Tel. (201) 784-1000 Fax (201) 784-0111	Drawing Title: GT-46600-6024-T2, ICT/ITE Power Supply, Efficiency Level: USA DOE Level VI / Eco-design Directive 2009/125/EC, (EU) 2019/1782, Case Color/Style: GlobTek Black, Desktop/External, Regulated Switchmode AC-DC Power Supply AC Adaptor, Input Rating: 100-240V~, 50-60 Hz, IEC 60320/C8, Output Rating: 60W, 24.0V@2.5A, Output Configuration: 1530 mm, 18/2 Cond, UL 2468, Female Barrel 5.5 * 2.5 * 11mm with internal Spring Clip and Locking Notch or Equal, Ferrite: Core Size: 14.2*28.5*8.2, GlobTek Black, GT Cord # C2285, Pin Out: Center Positive (+V), Blades/Input Cord: Not Applicable, Approvals: 230V CoC Tier 2; Saudi; CB 60335; EAC; CB 60950; UKCA; Malaysia; cULus; NrCAN (12V and 15V); Morocco; CB 62368; FCC; cULus; CE; CE; China RoHS; Double Insulation; Level VI; LPS 60950; PSE; RoHS; Ukraine; VCCI; WEEE; CCC; PSE; RCM;	
	Model No. GT-46600-6024-T2	
	Part No./Ordering No. TR9KI2500LCP-N(R6B)	Rev B

OUTPUT CORD AND CONNECTOR: LCL/C2285

ACTUAL CONNECTORS, OVERMOLDS, FERRITES MAY VARY SLIGHTLY FROM THE PICTURE BELOW

CABLE TYPE	UL 2468
CABLE LENGTH (mm)	1530
CABLE TOLERANCE (mm)	+150,-0
WIRE GAUGE (AWG)	18
CONDUCTORS	2
HANK DIMENSION (mm)	95 ± 10
CABLE / CONNECTOR OVERMOLD COLOR	GlobTek Black
FERRITE TYPE / DIMENSION	Core Size: 14.2*28.5*8.2
FERRITE # OF TURNS (Definition)	2 Pass thru core (1 turns)
FERRITE DIMENSION FROM STRAIN RELIEF	50 ± 10
FERRITE DIMENSION FROM PLUG	N/A
PLUG TYPE	Female Barrel 5.5 * 2.5 * 11mm with internal Spring Clip and Locking Notch or Equal
OUTPUT CONNECTOR GENDER	
OVERMOLDED	
OVER MOLD ORIENTATION	Straight
CONNECTOR PIN OUT:	Center Positive (+V)
ADDITIONAL REQUIREMENTS	

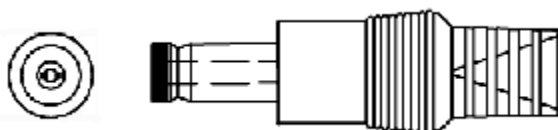

ADDITIONAL OUTPUT PLUG OPTIONS ARE AVAILABLE AT <https://www.globtek.com/connectors/>
STANDARD PLUGS AND CONNECTORS CAN BE SEEN ONLINE AT <https://www.globtek.com/connectors/>
CALCULATE VOLTAGE REGULATION/DROP WITH OUR ONLINE CALCULATOR: <https://en.globtek.com/output-cable-regulation-calculator/>

GloTek, Inc. www.globtek.com 186 Veterans Drive, Northvale, NJ 07647 Tel. (201) 784-1000 Fax (201) 784-0111	Drawing Title: GT-46600-6024-T2, ICT/ITE Power Supply, Efficiency Level: USA DOE Level VI / Eco-design Directive 2009/125/EC, (EU) 2019/1782, Case Color/Style: GlobTek Black, Desktop/External, Regulated Switchmode AC-DC Power Supply AC Adaptor, Input Rating: 100-240V~, 50-60 Hz, IEC 60320/C8 , Output Rating: 60W, 24.0V@2.5A, Output Configuration: 1530 mm, 18/2 Cond, UL 2468, Female Barrel 5.5 * 2.5 * 11mm with internal Spring Clip and Locking Notch or Equal, Ferrite: Core Size: 14.2*28.5*8.2, GlobTek Black, GT Cord # C2285, Pin Out: Center Positive (+V), Blades/Input Cord: Not Applicable, Approvals: 230V CoC Tier 2; Saudi; CB 60335; EAC; CB 60950; UKCA; Malaysia; cULus; NrCAN (12V and 15V); Morocco; CB 62368; FCC; cULus; CE; CE; China RoHS; Double Insulation; Level VI; LPS 60950; PSE; RoHS; Ukraine; VCCI; WEEE; CCC; PSE; RCM;	
	Model No. GT-46600-6024-T2	
	Part No./Ordering No. TR9KI2500LCP-N(R6B)	Rev B

OUTPUT CONNECTOR HOOK UP

TO ADDRESS SYSTEM-LEVEL EMI CONCERNS, FERRITE CHOKES/BEADS MAY BE ADDED/REVISED UPON REQUEST. A SAMPLE KIT OF GLOBTEK'S STANDARD FERRITES IS AVAILABLE UNDER GLOBTEK P/N: EMI-MITIGATION-KIT1

FOR ADDITIONAL INFORMATION, PLEASE READ OUR WHITE PAPER AT:

<https://en.globtek.com/technical-articles/ferrite-kit-radiated-emi-suppression-kit-for-globtek-power-supplies-cable-assemblies>

GloTek, Inc. www.globtek.com 186 Veterans Drive, Northvale, NJ 07647 Tel. (201) 784-1000 Fax (201) 784-0111	Drawing Title: GT-46600-6024-T2, ICT/ITE Power Supply, Efficiency Level: USA DOE Level VI / Eco-design Directive 2009/125/EC, (EU) 2019/1782, Case Color/Style: GlobTek Black, Desktop/External, Regulated Switchmode AC-DC Power Supply AC Adaptor, Input Rating: 100-240V~, 50-60 Hz, IEC 60320/C8, Output Rating: 60W, 24.0V@2.5A, Output Configuration: 1530 mm, 18/2 Cond, UL 2468, Female Barrel 5.5 * 2.5 * 11mm with internal Spring Clip and Locking Notch or Equal, Ferrite: Core Size: 14.2*28.5*8.2, GlobTek Black, GT Cord # C2285, Pin Out: Center Positive (+V), Blades/Input Cord: Not Applicable, Approvals: 230V CoC Tier 2; Saudi; CB 60335; EAC; CB 60950; UKCA; Malaysia; cULus; NrCAN (12V and 15V); Morocco; CB 62368; FCC; cULus; CE; CE; China RoHS; Double Insulation; Level VI; LPS 60950; PSE; RoHS; Ukraine; VCCI; WEEE; CCC; PSE; RCM;	
	Model No. GT-46600-6024-T2	
	Part No./Ordering No. TR9KI2500LCP-N(R6B)	Rev B

LABEL:L-1186

LABEL P/N:	Standard GT
MATERIAL:	Flat Thermal Transfer, Imprintable, Polyester Label and/or Pad Printed and/or Molded, and/or Laser Engraved in the case
BACKGROUND COLOR:	Black if housing is Black, White or Silver if housing is White or Gray.
TEXT COLOR:	White or Silver if label is Black Background for Black housing. Black if label is White or Silver background and Housing is White or Gray.
LABEL WIDTH (mm):	37.3
LABEL HEIGHT (mm):	77.3
SPECIAL BARCODE LABEL MATERIAL:	No

Below is the minimum information which will appear on the label. NOTE: in the logo area additional/actual positioning of symbols and text is subjected to change as per agency updates/requirements or additional model approvals become available. Regulatory certifications/label markings may be in logo area on the label or molded into the case housing outside the label area. Information will be shown via label and/or pad printed and/or molded and/or laser engraved in the case. * Date code markings at GlobTek option

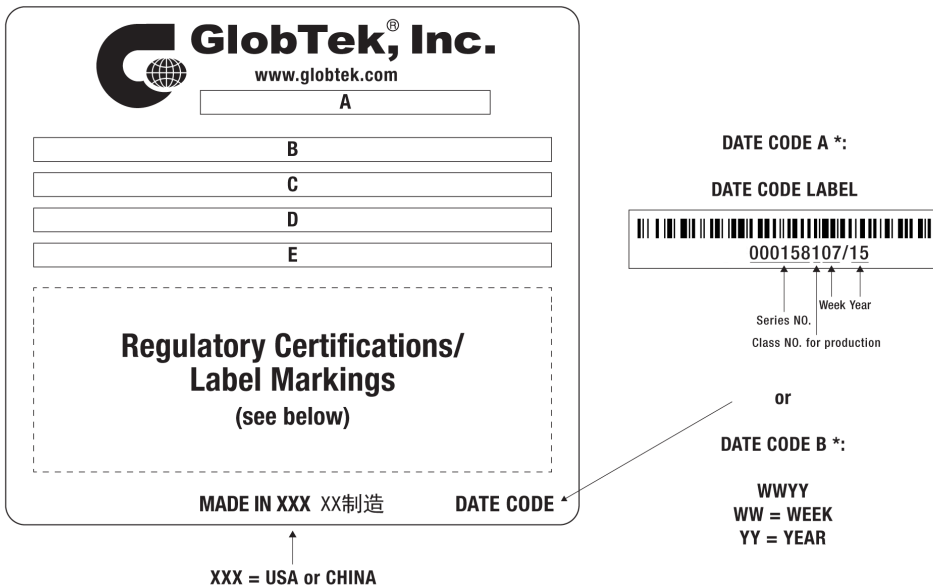

A=ICT/ITE Power Supply
B=P/N: (料号) TR9KI2500LCP-N(R6B)
C=Model (型号) GT-46600-6024-T2
D=Input (输入)100-240V~, 50-60 Hz, 1.5A
E=Output (输出)24.0 V 2.5 A, 60.0W

GlobTek, Inc. www.globtek.com 186 Veterans Drive, Northvale, NJ 07647 Tel. (201) 784-1000 Fax (201) 784-0111	Drawing Title: GT-46600-6024-T2, ICT/ITE Power Supply, Efficiency Level: USA DOE Level VI / Eco-design Directive 2009/125/EC, (EU) 2019/1782, Case Color/Style: GlobTek Black, Desktop/External, Regulated Switchmode AC-DC Power Supply AC Adaptor, Input Rating: 100-240V~, 50-60 Hz, IEC 60320/C8, Output Rating: 60W, 24.0V@2.5A, Output Configuration: 1530 mm, 18/2 Cond, UL 2468, Female Barrel 5.5 * 2.5 * 11mm with internal Spring Clip and Locking Notch or Equal, Ferrite: Core Size: 14.2*28.5*8.2, GlobTek Black, GT Cord # C2285, Pin Out: Center Positive (+V), Blades/Input Cord: Not Applicable, Approvals: 230V CoC Tier 2; Saudi; CB 60335; EAC; CB 60950; UKCA; Malaysia; cULus; NrCAN (12V and 15V); Morocco; CB 62368; FCC; cULus; CE; CE; China RoHS; Double Insulation; Level VI; LPS 60950; PSE; RoHS; Ukraine; VCCI; WEEE; CCC; PSE; RCM;
	Model No. GT-46600-6024-T2 Part No./Ordering No. TR9KI2500LCP-N(R6B)

AGENCY ONLINE DOCUMENTS	http://www.globtek.info/certs/GT-46600-60VV-X.X/
CE EC-Declaration for Medical	Contact GlobTek for more information
CE EC-Declaration for Industrial/Commercial/ITE	http://globtek.force.com/models/ec_declaration_product?id=01ta0000005wpSf&i=2
CE EC-Declaration for Household	Contact GlobTek for more information
UKCA-Declaration for Medical	Contact GlobTek for more information
UKCA-Declaration for Industrial/Commercial/ITE	http://globtek.force.com/models/ukca_declaration_product?id=01ta0000005wpSf&i=2
UKCA-Declaration for Household	Contact GlobTek for more information
Morocco SDoC Declaration	https://globtek.secure.force.com/models/Morocco_SDoC_Declaration?id=a00a000000MikA1EAJ
RoHS/RoHS3 Declaration	https://www.globtek.com/pdf/rohs_cert/01ta0000005wpSfAAI
REACH Declaration	https://www.globtek.com/pdf/iso_certificates/REACH.pdf
Conflict Minerals Declaration	https://www.globtek.com/pdf/conflict-minerals.pdf
Prop 65 Statement	https://en.globtek.com/prop-65-statement.pdf

IPXY rating is based on 3rd party testing and customers should check suitability and test system level IPXY rating before ordering.

Regulatory Certifications/Label Markings

LATEST PRODUCT/MODEL CERTIFICATIONS: <https://en.globtek.com/datasheet/id/a00a000000MikA1>

AGENCY ONLINE DOCUMENTS: <http://www.globtek.info/certs/GT-46600-60VV-X.X/>



(F1) Class II / Double Insulated

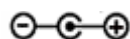

Center Positive (+V)

GloTek, Inc. www.globtek.com 186 Veterans Drive, Northvale, NJ 07647 Tel. (201) 784-1000 Fax (201) 784-0111	Drawing Title: GT-46600-6024-T2, ICT/ITE Power Supply, Efficiency Level: USA DOE Level VI / Eco-design Directive 2009/125/EC, (EU) 2019/1782, Case Color/Style: GlobTek Black, Desktop/External, Regulated Switchmode AC-DC Power Supply AC Adaptor, Input Rating: 100-240V~, 50-60 Hz, IEC 60320/C8 , Output Rating: 60W, 24.0V@2.5A, Output Configuration: 1530 mm, 18/2 Cond, UL 2468, Female Barrel 5.5 * 2.5 * 11mm with internal Spring Clip and Locking Notch or Equal, Ferrite: Core Size: 14.2*28.5*8.2, GlobTek Black, GT Cord # C2285, Pin Out: Center Positive (+V), Blades/Input Cord: Not Applicable, Approvals: 230V CoC Tier 2; Saudi; CB 60335; EAC; CB 60950; UKCA; Malaysia; cULus; NrCAN (12V and 15V); Morocco; CB 62368; FCC; cULus; CE; CE; China RoHS; Double Insulation; Level VI; LPS 60950; PSE; RoHS; Ukraine; VCCI; WEEE; CCC; PSE; RCM;	
	Model No. GT-46600-6024-T2	
	Part No./Ordering No. TR9KI2500LCP-N(R6B)	Rev B

PACKAGING

Packing Spec P/N:	PACKING FOR GT-46600, User manual
Box Qty:	45
Gift Box Size (mm):	Egg Crate
Gift Box Color:	White
Master Carton Size (mm):	520 x 370 x 205
Master Carton Cubic Volume (m³):	0.04
Master GW (Kg):	15.6 kg
BLADES INCLUDED:	N/A: Not Applicable
BLADE/CORD INSTALLED:	N/A: Not Applicable
USER MANUAL*:	809-DESKTOPUSERMANUAL on A4 paper
USER MANUAL WEB LINK:	https://en.globtek.com/pdf/809-DESKTOPUSERMANUAL.jpg

* This specification sheet is considered the user manual for all applications. It is expected that the buyer of this product will use it to formulate their own user manual for their end product and a user manual specifically for the power adapter is not usually required. If a user manual is not specifically listed above then none will be provided with this unit.

PROPRIETARY INFORMATION

<p>GlobTek, Inc. www.globtek.com 186 Veterans Drive, Northvale, NJ 07647 Tel. (201) 784-1000 Fax (201) 784-0111</p>	<p>Drawing Title: GT-46600-6024-T2, ICT/ITE Power Supply, Efficiency Level: USA DOE Level VI / Eco-design Directive 2009/125/EC, (EU) 2019/1782, Case Color/Style: GlobTek Black, Desktop/External, Regulated Switchmode AC-DC Power Supply AC Adaptor, Input Rating: 100-240V~, 50-60 Hz, IEC 60320/C8, Output Rating: 60W, 24.0V@2.5A, Output Configuration: 1530 mm, 18/2 Cond, UL 2468, Female Barrel 5.5 * 2.5 * 11mm with internal Spring Clip and Locking Notch or Equal, Ferrite: Core Size: 14.2*28.5*8.2, GlobTek Black, GT Cord # C2285, Pin Out: Center Positive (+V), Blades/Input Cord: Not Applicable, Approvals: 230V CoC Tier 2; Saudi; CB 60335; EAC; CB 60950; UKCA; Malaysia; cULus; NrCAN (12V and 15V); Morocco; CB 62368; FCC; cULus; CE; CE; China RoHS; Double Insulation; Level VI; LPS 60950; PSE; RoHS; Ukraine; VCCI; WEEE; CCC; PSE; RCM;</p> <p>Model No. GT-46600-6024-T2</p> <p>Part No./Ordering No. TR9KI2500LCP-N(R6B)</p>	<p>Rev B</p>
--	--	--------------

If specific packaging is required, this section must specify all requirements and note "no exceptions". If this section does not specify packaging, it is subject to change without notice at GlobTek's discretion

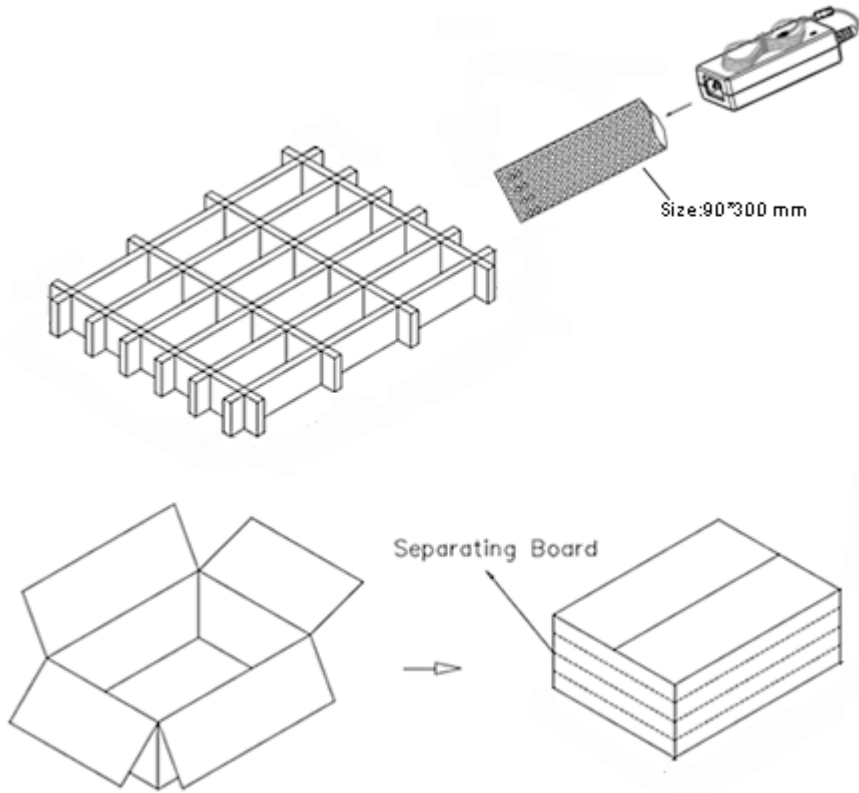

GloTek, Inc. www.globtek.com 186 Veterans Drive, Northvale, NJ 07647 Tel. (201) 784-1000 Fax (201) 784-0111	Drawing Title: GT-46600-6024-T2, ICT/ITE Power Supply, Efficiency Level: USA DOE Level VI / Eco-design Directive 2009/125/EC, (EU) 2019/1782, Case Color/Style: GlobTek Black, Desktop/External, Regulated Switchmode AC-DC Power Supply AC Adaptor, Input Rating: 100-240V~, 50-60 Hz, IEC 60320/C8 , Output Rating: 60W, 24.0V@2.5A, Output Configuration: 1530 mm, 18/2 Cond, UL 2468, Female Barrel 5.5 * 2.5 * 11mm with internal Spring Clip and Locking Notch or Equal, Ferrite: Core Size: 14.2*28.5*8.2, GlobTek Black, GT Cord # C2285, Pin Out: Center Positive (+V), Blades/Input Cord: Not Applicable, Approvals: 230V CoC Tier 2; Saudi; CB 60335; EAC; CB 60950; UKCA; Malaysia; cULus; NrCAN (12V and 15V); Morocco; CB 62368; FCC; cULus; CE; CE; China RoHS; Double Insulation; Level VI; LPS 60950; PSE; RoHS; Ukraine; VCCI; WEEE; CCC; PSE; RCM;	
	Model No. GT-46600-6024-T2	
	Part No./Ordering No. TR9KI2500LCP-N(R6B)	Rev B

INSTRUCTIONS TO THE OEM SYSTEMS ENGINEER

It is the responsibility of the OEM systems engineer to provide the end system user instructions and warnings for the use of this product in the end system.

If an input cord is required for this product, AC Mains voltage should be provided to the power supply by a power supply cord approved to the national standards of the country in which it will be used.

This power supply is not designed to be repaired. No serviceable parts inside. A blown internal fuse is an indication of catastrophic failure of circuit component(s). If a Failure Analysis is required for a failed power supply/battery charger, please return the damaged unit to GlobTek for an accurate determination of the root cause of the failure.

EMC Compliance of the complete OEM product, including the GlobTek power supply/battery charger needs to be verified by the OEM systems engineer.

INSTRUCTION SHEET

N/A