

GloBtek, Inc. www.globtek.com 186 Veterans Drive, Northvale, NJ 07647 Tel. (201) 784-1000 Fax (201) 784-0111	Drawing Title: GTM96180-1807-1.05-T3, ITE / Medical Power Supply/Class 2/Household Power Supply, Efficiency Level: USA DOE Level VI / Eco-design Directive 2009/125/EC, (EU) 2019/1782, Case Color/Style: GloBtek Black, Desktop/External, Regulated Switchmode AC-DC Power Supply AC Adaptor, Input Rating: 100-240V~, 50-60 Hz, IEC 60320/C14 , Output Rating: 18W, 5.95V@3.0A, Output Configuration: 1200 mm, 16/2 Cond, UL 2464, Female Barrel 5.5 * 2.5 * 11mm with internal Spring Clip and Locking Notch or Equal, Ferrite: None, GloBtek Black, GT Cord # C3338, Pin Out: Center Positive (+V), Blades/Input Cord: Not Applicable, Approvals: Taiwan BSMI; IP42; CB 62368; CB 60950; Class I; 230V CoC Tier 2; cULus (9V only); Korea (12V Only); EAC; Morocco; NOM (9V only); S-Mark 60950; ETL; CCC; CE; IRAM; CB 60335; cETLus UL1310; Fuse 60335; Fuse 60335; CE; China RoHS; Level VI; LPS 60950; RoHS;Ukraine; VCCI; WEEE; PSE; PSE; FCC; CAN ICES-3; cETLus; cETLus 60601-1 3rd; CB 60601-1; RCM;	
	Model No. GTM96180-1807-1.05-T3	
	Part No./Ordering No. TR9CB3000LCP-IM(R6B)	Rev A1

## REVISION HISTORY

REV	DESCRIPTION	SUB	DATE	APPROVED
A1	Update Ukraine, CCC approvals, add EAC,IRAM BSMI, change packing to 60 psc, gift box to 147*100*33 mm, master carton to 465*415*225 mm	QA	09/30/2019	QA
A	Initial Release	bsiep	01/11/2017	QA

In Addition to GloBtek Inc.'s renewed ISO9001:2015 - Quality Management System Certification, GloBtek Inc. is now certified to:

ISO13485:2016 - Medical Devices Quality Management System Certification

ISO14001:2015 - Environmental Management System Certification

ISO Certificates are available online at <https://www.globtek.com/iso-certificates/>

### Customer Approval of Specification:

Please approve, sign and send back to GloBtek so we can complete order processing.

A delay in receipt of this form will delay delivery schedule.

Company Name:

Customer P/N:

Quote Number:

Date:

Authorized Representative Name:

Authorized Representative Signature:

The acceptance of this specification and use of the product described in this document indicates the acceptance and binding of the customer to GloBtek terms and conditions, which supersede all other agreements, terms, and conditions (<https://en.globtek.com/terms-and-conditions/>).

The purchaser of this product (Customer) agrees that it is their sole responsibility to determine suitability/fitness of the product described in this specification for their application and to take precautions for protection against any hazards attendant to the handling and use of the product.

### Footnote:

GloBtek Inc. will not be liable for the safety and performance of these power supplies if unauthorized access and repair occurs. End user should consult applicable UL, CSA or EN standards for proper installation instruction.

### Limitation of Use:

GloBtek products are intended for use with commercial, medical, and/or industrial equipment only. GloBtek product are not authorized for use as mission critical components in life support hazardous environment, nuclear or aircraft applications without prior written approval from the CEO of GloBtek Inc.

Contents of this document are subject to change without prior notice.

<b>GlobTek, Inc.</b> www.globtek.com 186 Veterans Drive, Northvale, NJ 07647 Tel. (201) 784-1000 Fax (201) 784-0111	Drawing Title: GTM96180-1807-1.05-T3, ITE / Medical Power Supply/Class 2/Household Power Supply, Efficiency Level: USA DOE Level VI / Eco-design Directive 2009/125/EC, (EU) 2019/1782, Case Color/Style: GlobTek Black, Desktop/External, Regulated Switchmode AC-DC Power Supply AC Adaptor, Input Rating: 100-240V~, 50-60 Hz, IEC 60320/C14 , Output Rating: 18W, 5.95V@3.0A, Output Configuration: 1200 mm, 16/2 Cond, UL 2464, Female Barrel 5.5 * 2.5 * 11mm with internal Spring Clip and Locking Notch or Equal, Ferrite: None, GlobTek Black, GT Cord # C3338, Pin Out: Center Positive (+V), Blades/Input Cord: Not Applicable, Approvals: Taiwan BSMI; IP42; CB 62368; CB 60950; Class I; 230V CoC Tier 2; cULus (9V only); Korea (12V Only); EAC; Morocco; NOM (9V only); S-Mark 60950; ETL; CCC; CE; IRAM; CB 60335; cETLus UL1310; Fuse 60335; Fuse 60335; CE; China RoHS; Level VI; LPS 60950; RoHS;Ukraine; VCCI; WEEE; PSE; PSE; FCC; CAN ICES-3; cETLus; cETLus 60601-1 3rd; CB 60601-1; RCM;	
	Model No. GTM96180-1807-1.05-T3	
	Part No./Ordering No. TR9CB3000LCP-IM(R6B)	Rev A1

## POWER SUPPLY INFORMATION

TYPE:	Desktop/External
TECHNOLOGY:	Regulated Switchmode AC-DC Power Supply AC Adaptor
CASE COLOR:	GlobTek Black
NAMEPLATE RATED INPUT:	100-240V~, 50-60 Hz, 0.6 A
INPUT CONFIG:	IEC 60320/C14
WATTS:	18.0
VOLTS OUT:	5.95
CURRENT OUT (Amps):	3.0
BLADE/CORD INCLUDED:	N/A
BLADE/CORD INSTALLED:	N/A
INGRESS PROTECTION:	IP42
GROUNDING CONFIGURATION:	(E1) Earthed output
EFFICIENCY LEVEL:	
OUTPUT CONFIGURATION:	1200 mm, 16/2 Cond, UL 2464, Female Barrel 5.5 * 2.5 * 11mm with internal Spring Clip and Locking Notch or Equal, Ferrite: None, GlobTek Black, GT Cord # C3338
CONNECTOR PIN OUT:	Center Positive (+V)
LABEL SPECS:	Standard GT,L-1186
SPECIAL BARCODE LABEL	
MATERIAL:	
PACK SPEC:	Standard DT, Individually Box, GT User Manual
USER MANUAL:	809-DESKTOPUSERMANUAL on A4 paper

### PROPRIETARY INFORMATION

PROPRIETARY OF GLOBTEK, INC. ANY REPRODUCTION, DISCLOSURE OR USE OF THIS DRAWING, IN WHOLE OR IN PART, IS HEREBY PROHIBITED EXCEPT AS SPECIFIED IN WRITING BY GLOBTEK, INC. © GlobTek, Inc. 2016 - 2020

GloTek, Inc. www.globtek.com 186 Veterans Drive, Northvale, NJ 07647 Tel. (201) 784-1000 Fax (201) 784-0111	Drawing Title: GTM96180-1807-1.05-T3, ITE / Medical Power Supply/Class 2/Household Power Supply, Efficiency Level: USA DOE Level VI / Eco-design Directive 2009/125/EC, (EU) 2019/1782, Case Color/Style: GlobTek Black, Desktop/External, Regulated Switchmode AC-DC Power Supply AC Adaptor, Input Rating: 100-240V~, 50-60 Hz, IEC 60320/C14 , Output Rating: 18W, 5.95V@3.0A, Output Configuration: 1200 mm, 16/2 Cond, UL 2464, Female Barrel 5.5 * 2.5 * 11mm with internal Spring Clip and Locking Notch or Equal, Ferrite: None, GlobTek Black, GT Cord # C3338, Pin Out: Center Positive (+V), Blades/Input Cord: Not Applicable, Approvals: Taiwan BSMI; IP42; CB 62368; CB 60950; Class I; 230V CoC Tier 2; cULus (9V only); Korea (12V Only); EAC; Morocco; NOM (9V only); S-Mark 60950; ETL; CCC; CE; IRAM; CB 60335; cETLus UL1310; Fuse 60335; Fuse 60335; CE; China RoHS; Level VI; LPS 60950; RoHS;Ukraine; VCCI; WEEE; PSE; PSE; FCC; CAN ICES-3; cETLus; cETLus 60601-1 3rd; CB 60601-1; RCM;	
	Model No. GTM96180-1807-1.05-T3	
	Part No./Ordering No. TR9CB3000LCP-IM(R6B)	Rev A1

Notes/Modifications/Customizations (notes in this section supersede the values shown in the standard spec):  
DIMENSIONS ARE IN MM UNLESS SPECIFIED OTHERWISE.

GlobTek, Inc. www.globtek.com 186 Veterans Drive, Northvale, NJ 07647 Tel. (201) 784-1000 Fax (201) 784-0111	Drawing Title: GTM96180-1807-1.05-T3, ITE / Medical Power Supply/Class 2/Household Power Supply, Efficiency Level: USA DOE Level VI / Eco-design Directive 2009/125/EC, (EU) 2019/1782, Case Color/Style: GlobTek Black, Desktop/External, Regulated Switchmode AC-DC Power Supply AC Adaptor, Input Rating: 100-240V~, 50-60 Hz, IEC 60320/C14, Output Rating: 18W, 5.95V@3.0A, Output Configuration: 1200 mm, 16/2 Cond, UL 2464, Female Barrel 5.5 * 2.5 * 11mm with internal Spring Clip and Locking Notch or Equal, Ferrite: None, GlobTek Black, GT Cord # C3338, Pin Out: Center Positive (+V), Blades/Input Cord: Not Applicable, Approvals: Taiwan BSMI; IP42; CB 62368; CB 60950; Class I; 230V CoC Tier 2; cULus (9V only); Korea (12V Only); EAC; Morocco; NOM (9V only); S-Mark 60950; ETL; CCC; CE; IRAM; CB 60335; cETLus UL1310; Fuse 60335; Fuse 60335; CE; China RoHS; Level VI; LPS 60950; RoHS;Ukraine; VCCI; WEEE; PSE; PSE; FCC; CAN ICES-3; cETLus; cETLus 60601-1 3rd; CB 60601-1; RCM;	
	Model No. GTM96180-1807-1.05-T3	
	Part No./Ordering No. TR9CB3000LCP-IM(R6B)	Rev A1

## ELECTRICAL SPECIFICATIONS

### A) ELECTRICAL SPECIFICATIONS:

01. Input Voltage: Specified 90-264 Vac, Nameplate rated: 100-240Vac
  - 90-264 Vac range @ 100% of rated load current
  - 85-264 Vac range @ 85% of rated load current
  - 110-370 VDC range @ 100% of rated load current
02. Input Frequency: Specified 47-63 Hz, Nameplate rated 50-60Hz
03. Output Regulation: +/- 5% measured at the output connector
04. Line Voltage Regulation: +/- 0.5% typical measured at full load
05. Green Power On Indicator LED
06. Output Ripple (Vp-p): 1% or 100 mV whichever is greater, measured at 20 MHz bandwidth with 0.1 uf ceramic capacitor in parallel with a low impedance 47 uf electrolytic capacitor connected at the end of the output connector
07. Turn-ON/OFF Overshoot: 5% maximum, 1 mS typical recovery time for 40% to 70% step load
08. Turn-ON Delay: 1 second maximum @ full load, nominal line
09. Hold-Up Time: 8 mS typical @ nominal input voltage and full load
10. Inrush Current: 30A/60A maximum cold start @ 115/230Vac input
11. Efficiency: Compliant with Efficiency Level VI and CoC Tier 2 standards
12. No Load Standby Power: <0.075 W @ 230Vac

### B) PROTECTION

01. Input Protection: Input line fusing and 300Vac MOV
02. Short Circuit/ Overload: Electronically Protected unit will auto recover upon removal of fault
  - Output Current Limit: 110% to 160% of rated output current
  - (upper end of current limit range is determined by normal output power rating, not derated output power level)
03. Output Over-Voltage: 110% to 130% of nominal output voltage

### C) SAFETY

01. Dielectric Withstand Voltage: 4000Vac or 5656Vdc from input to output, On Class I models, 3000Vac or 4242Vdc from input to earth
02. Earth Leakage Current: Class I models < 300uA, N/A for Class II models
03. Touch Current: Class I models < 20uA, Class II models < 75uA
04. Output Floating or Earthed option for Class I desktop models.
  - See Output Isolation Options for details
05. Earth Continuity Test: < 0.1 Ohm between Earth Pin at AC input and PCB termination point (Class I models only)
06. Means of Protection: 2 x MOPP
07. Compliant Standards: See listings at end of this drawing for specifics

### D) EMC

- EN 60601-1-2, 4th edition
- Emissions, per EN 55032, EN 61000-6-3, EN 61000-6-4
- Conducted Emissions: Class B, FCC Part 15, Class B
  - Radiated Emissions: Class B, FCC Part 15, Class B
- Line Frequency Harmonics EN61000-3-2, Class A
- Voltage Fluctuations/Flicker EN61000-3-3

Immunity, per EN 55024, EN 61000-6-1, EN 61000-6-2

#### PROPRIETARY INFORMATION

PROPRIETARY OF GLOBTEK, INC. ANY REPRODUCTION, DISCLOSURE OR USE OF THIS DRAWING, IN WHOLE OR IN PART, IS HEREBY PROHIBITED EXCEPT AS SPECIFIED IN

WRITING BY GLOBTEK, INC. © GlobTek, Inc. 2016 - 2020

quest /04/09/2020 11:01:53 AM CLONED FROM TR9CA4000LCP-N(R6B)

GloBtek, Inc. www.globtek.com 186 Veterans Drive, Northvale, NJ 07647 Tel. (201) 784-1000 Fax (201) 784-0111	Drawing Title: GTM96180-1807-1.05-T3, ITE / Medical Power Supply/Class 2/Household Power Supply, Efficiency Level: USA DOE Level VI / Eco-design Directive 2009/125/EC, (EU) 2019/1782, Case Color/Style: GlobTek Black, Desktop/External, Regulated Switchmode AC-DC Power Supply AC Adaptor, Input Rating: 100-240V~, 50-60 Hz, IEC 60320/C14 , Output Rating: 18W, 5.95V@3.0A, Output Configuration: 1200 mm, 16/2 Cond, UL 2464, Female Barrel 5.5 * 2.5 * 11mm with internal Spring Clip and Locking Notch or Equal, Ferrite: None, GlobTek Black, GT Cord # C3338, Pin Out: Center Positive (+V), Blades/Input Cord: Not Applicable, Approvals: Taiwan BSMI; IP42; CB 62368; CB 60950; Class I; 230V CoC Tier 2; cULus (9V only); Korea (12V Only); EAC; Morocco; NOM (9V only); S-Mark 60950; ETL; CCC; CE; IRAM; CB 60335; cETLus UL1310; Fuse 60335; Fuse 60335; CE; China RoHS; Level VI; LPS 60950; RoHS;Ukraine; VCCI; WEEE; PSE; PSE; FCC; CAN ICES-3; cETLus; cETLus 60601-1 3rd; CB 60601-1; RCM;	
	Model No. GTM96180-1807-1.05-T3	
	Part No./Ordering No. TR9CB3000LCP-IM(R6B)	Rev A1

Static Discharge Immunity EN61000-4-2, 10kV Contact Discharge, 20kV air discharge  
Radiated RF Immunity EN61000-4-3, 10V/m 80-1000MHz, 3V/m 1-2.7GHz, 80% 1KHz AM.  
EFT/Burst Immunity EN61000-4-4, 4kV/100kHz.  
Line Surge Immunity EN61000-4-5, 2kV differential, 4kV common-mode  
Conducted RF Immunity EN61000-4-6, 3Vrms, 80% 1KHz AM  
Power Frequency Magnetic Field Immunity EN61000-4-8, 3A/m  
Voltage Dip Immunity EN61000-4-11, Criteria

E) OTHER:

01. MTBF: 1,000,000 Hours @ 40°C ambient temperature, Full load
02. GTM96180 Family: -20°C to 40°C ambient temperature, Full load  
Regarding Operating Temperature,
  - a- See below derating table for output power capability at alternate temperature
  - b- Extended low end temperature range available as custom option
03. Operating Humidity: 0% to 95% relative humidity, non-condensing
04. Storage Temperature: -30°C to 80°C
05. Operating Altitude: 5000 Meters
06. Ingress Protection: IP40 standard, IP52 available as special option
07. ROHS: Compliant with latest regulations, see approvals section below

F) ENCLOSURE

01. Housing: High impact plastic, 94V0 polycarbonate, non-vented
02. Markings: Label or Laser Printed
03. AC Input mechanical options: Class II Wall Plug-in, Changeable Blades  
Desktop Option, extended housing: C6, C8, C14 or C18 IEC Inlet.

G) SPECIAL OPTIONS

01. Cost reduction, removal of LED
  02. Custom Cordsets, various cordage types, and connector types\*
  03. Custom Markings
  04. Short term Output Surge Capability
  05. Reduced Leakage Current versions (10uA max), for CF medical applications, and AC noise sensitive equipment, 15W or less, 5V to 24V output voltage range.
  06. Tightened output voltage tolerance
  07. Reduced output ripple level
  08. Reduced output power rating marking
  09. High Rel PCB laminate with Plated through Holes for IPC610 Class 2 Compliance
  10. Special Housing Colors and Cordset Colors
  11. Quasi Constant Current Output, for Lead-Acid Battery Charger Applications
- \* 5Vdc USB output connector power supplies, which use the Micro-B or C-type style connector, have a max output voltage regulation specification of +/-8% (4.6V to 5.4V range).

TO ADDRESS SYSTEM-LEVEL EMI CONCERNS, FERRITE CHOKES/BEADS MAY BE ADDED/REVISED UPON REQUEST. A SAMPLE KIT OF GLOBTEK'S STANDARD FERRITES IS AVAILABLE UNDER GLOBTEK P/N: EMI-MITIGATION-KIT1

PROPRIETARY INFORMATION

PROPRIETARY OF GLOBTEK, INC. ANY REPRODUCTION, DISCLOSURE OR USE OF THIS DRAWING, IN WHOLE OR IN PART, IS HEREBY PROHIBITED EXCEPT AS SPECIFIED IN

WRITING BY GLOBTEK, INC. © GlobTek, Inc. 2016 - 2020

quest /04/09/2020 11:01:53 AM CLONED FROM TR9CA4000LCP-N(R6B)

GloTek, Inc. www.globtek.com 186 Veterans Drive, Northvale, NJ 07647 Tel. (201) 784-1000 Fax (201) 784-0111	Drawing Title: GTM96180-1807-1.05-T3, ITE / Medical Power Supply/Class 2/Household Power Supply, Efficiency Level: USA DOE Level VI / Eco-design Directive 2009/125/EC, (EU) 2019/1782, Case Color/Style: GlobTek Black, Desktop/External, Regulated Switchmode AC-DC Power Supply AC Adaptor, Input Rating: 100-240V~, 50-60 Hz, IEC 60320/C14 , Output Rating: 18W, 5.95V@3.0A, Output Configuration: 1200 mm, 16/2 Cond, UL 2464, Female Barrel 5.5 * 2.5 * 11mm with internal Spring Clip and Locking Notch or Equal, Ferrite: None, GlobTek Black, GT Cord # C3338, Pin Out: Center Positive (+V), Blades/Input Cord: Not Applicable, Approvals: Taiwan BSMI; IP42; CB 62368; CB 60950; Class I; 230V CoC Tier 2; cULus (9V only); Korea (12V Only); EAC; Morocco; NOM (9V only); S-Mark 60950; ETL; CCC; CE; IRAM; CB 60335; cETLus UL1310; Fuse 60335; Fuse 60335; CE; China RoHS; Level VI; LPS 60950; RoHS;Ukraine; VCCI; WEEE; PSE; PSE; FCC; CAN ICES-3; cETLus; cETLus 60601-1 3rd; CB 60601-1; RCM;	
	Model No. GTM96180-1807-1.05-T3	
	Part No./Ordering No. TR9CB3000LCP-IM(R6B)	Rev A1

FOR ADDITIONAL INFORMATION, PLEASE READ OUR WHITE PAPER AT:

<https://en.globtek.com/technical-articles/ferrite-kit-radiated-emi-suppression-kit-for-globtek-power-supplies-cable-assemblies>

INGRESS PROTECTION: IP42

GlobTek, Inc.  
 www.globtek.com  
 186 Veterans Drive,  
 Northvale, NJ 07647  
 Tel. (201) 784-1000  
 Fax (201) 784-0111

Drawing Title: GTM96180-1807-1.05-T3, ITE / Medical Power Supply/Class 2/Household Power Supply, Efficiency Level: USA DOE Level VI / Eco-design Directive 2009/125/EC, (EU) 2019/1782, Case Color/Style: GlobTek Black, Desktop/External, Regulated Switchmode AC-DC Power Supply AC Adaptor, Input Rating: 100-240V~, 50-60 Hz, IEC 60320/C14 , Output Rating: 18W, 5.95V@3.0A, Output Configuration: 1200 mm, 16/2 Cond, UL 2464, Female Barrel 5.5 \* 2.5 \* 11mm with internal Spring Clip and Locking Notch or Equal, Ferrite: None, GlobTek Black, GT Cord # C3338, Pin Out: Center Positive (+V), Blades/Input Cord: Not Applicable, Approvals: Taiwan BSMI; IP42; CB 62368; CB 60950; Class I; 230V CoC Tier 2; cULus (9V only); Korea (12V Only); EAC; Morocco; NOM (9V only); S-Mark 60950; ETL; CCC; CE; IRAM; CB 60335; cETLus UL1310; Fuse 60335; Fuse 60335; CE; China RoHS; Level VI; LPS 60950; RoHS;Ukraine; VCCI; WEEE; PSE; PSE; FCC; CAN ICES-3; cETLus; cETLus 60601-1 3rd; CB 60601-1; RCM;

Model No. GTM96180-1807-1.05-T3

Part No./Ordering No. TR9CB3000LCP-IM(R6B)

Rev A1

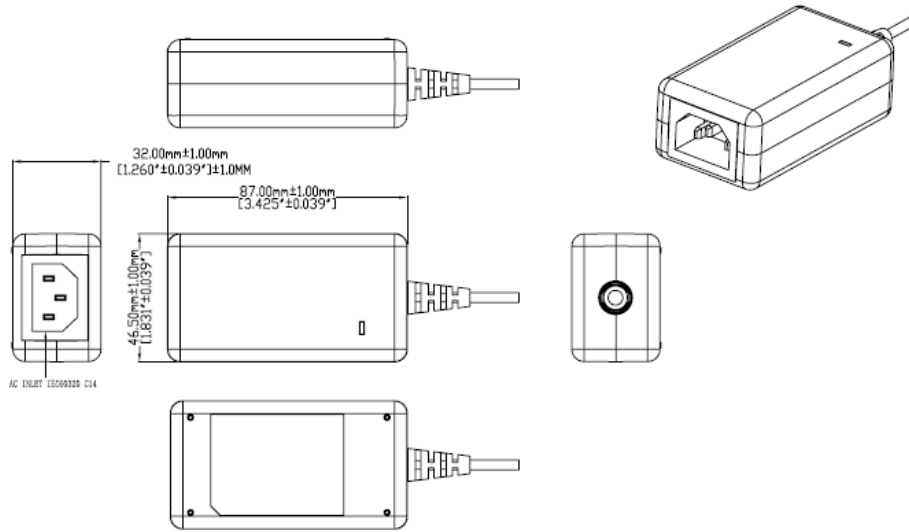

GlobTek, Inc.  
 www.globtek.com  
 186 Veterans Drive,  
 Northvale, NJ 07647  
 Tel. (201) 784-1000  
 Fax (201) 784-0111

Drawing Title: GTM96180-1807-1.05-T3, ITE / Medical Power Supply/Class 2/Household Power Supply, Efficiency Level: USA DOE Level VI / Eco-design Directive 2009/125/EC, (EU) 2019/1782, Case Color/Style: GlobTek Black, Desktop/External, Regulated Switchmode AC-DC Power Supply AC Adaptor, Input Rating: 100-240V~, 50-60 Hz, IEC 60320/C14, Output Rating: 18W, 5.95V@3.0A, Output Configuration: 1200 mm, 16/2 Cond, UL 2464, Female Barrel 5.5 \* 2.5 \* 11mm with internal Spring Clip and Locking Notch or Equal, Ferrite: None, GlobTek Black, GT Cord # C3338, Pin Out: Center Positive (+V), Blades/Input Cord: Not Applicable, Approvals: Taiwan BSMI; IP42; CB 62368; CB 60950; Class I; 230V CoC Tier 2; cULus (9V only); Korea (12V Only); EAC; Morocco; NOM (9V only); S-Mark 60950; ETL; CCC; CE; IRAM; CB 60335; cETLus UL1310; Fuse 60335; Fuse 60335; CE; China RoHS; Level VI; LPS 60950; RoHS;Ukraine; VCCI; WEEE; PSE; PSE; FCC; CAN ICES-3; cETLus; cETLus 60601-1 3rd; CB 60601-1; RCM;

Model No. GTM96180-1807-1.05-T3

Part No./Ordering No. TR9CB3000LCP-IM(R6B)

Rev A1

### DERATING CURVE

#### POWER SUPPLY DERATING CURVE

(For GTM96180 18W Energy Level VI Power Supplies)

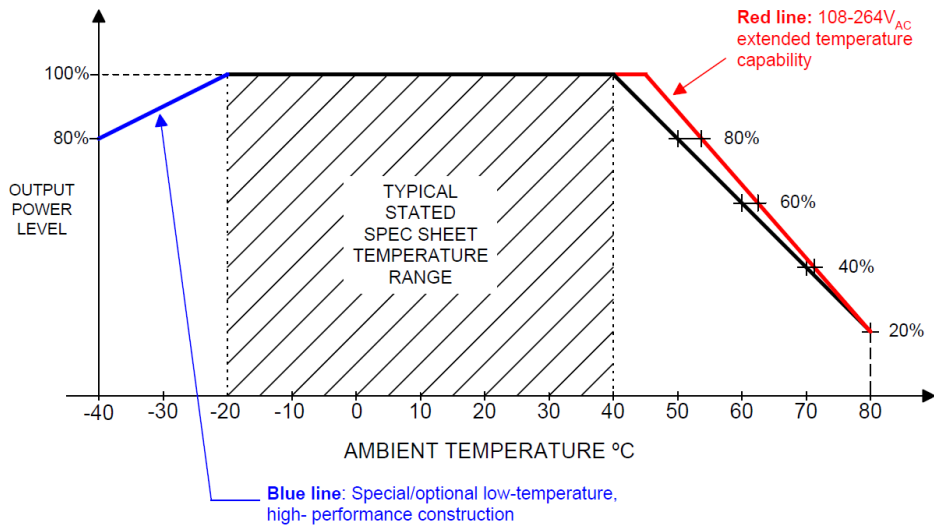



GlobTek, Inc. www.globtek.com 186 Veterans Drive, Northvale, NJ 07647 Tel. (201) 784-1000 Fax (201) 784-0111	Drawing Title: GTM96180-1807-1.05-T3, ITE / Medical Power Supply/Class 2/Household Power Supply, Efficiency Level: USA DOE Level VI / Eco-design Directive 2009/125/EC, (EU) 2019/1782, Case Color/Style: GlobTek Black, Desktop/External, Regulated Switchmode AC-DC Power Supply AC Adaptor, Input Rating: 100-240V~, 50-60 Hz, IEC 60320/C14 , Output Rating: 18W, 5.95V@3.0A, Output Configuration: 1200 mm, 16/2 Cond, UL 2464, Female Barrel 5.5 * 2.5 * 11mm with internal Spring Clip and Locking Notch or Equal, Ferrite: None, GlobTek Black, GT Cord # C3338, Pin Out: Center Positive (+V), Blades/Input Cord: Not Applicable, Approvals: Taiwan BSMI; IP42; CB 62368; CB 60950; Class I; 230V CoC Tier 2; cULus (9V only); Korea (12V Only); EAC; Morocco; NOM (9V only); S-Mark 60950; ETL; CCC; CE; IRAM; CB 60335; cETLus UL1310; Fuse 60335; Fuse 60335; CE; China RoHS; Level VI; LPS 60950; RoHS;Ukraine; VCCI; WEEE; PSE; PSE; FCC; CAN ICES-3; cETLus; cETLus 60601-1 3rd; CB 60601-1; RCM;	
	Model No. GTM96180-1807-1.05-T3	
	Part No./Ordering No. TR9CB3000LCP-IM(R6B)	Rev A1

## INPUT CONFIGURATION

(E1) Earthed output

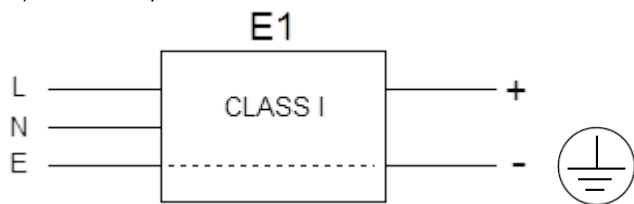

[Alternate grounding configurations](#) available upon request.

Blades/Cord Included:N/A:

Blades/Cord Installed:N/A:

IEC 60320/C14 AC Inlet Connector, Class I, Earth Ground

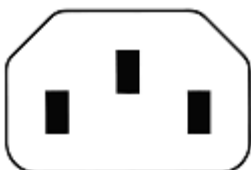

Mates with IEC 60320/C13 Plug

Optional Locking IEC60320 Receptable and cord option available on some models by request.:



## [Standard International IEC 320/C13 Cordsets](#)

Below are standard cordsets which are "not included" (unless stated above); these can be purchased separately or packaged with the power supply. Contact your Sales Engineer if the style required is not shown below. Many more available in different lengths, colors or cable material.

## Stock Power Supply Cords

Part Number/ Link	Country	Plug	Termination	Length (mm)	(Ft)
<a href="#">3021457F701(R)</a>	N. American (Type B)	NEMA 5-15P	IEC 320/C13	2150	7

### PROPRIETARY INFORMATION

PROPRIETARY OF GLOBTEK, INC. ANY REPRODUCTION, DISCLOSURE OR USE OF THIS DRAWING, IN WHOLE OR IN PART, IS HEREBY PROHIBITED EXCEPT AS SPECIFIED IN WRITING BY GLOBTEK, INC. © GlobTek, Inc. 2016 - 2020

quest /04/09/2020 11:01:53 AM CLONED FROM TR9CA4000LCP-N(R6B)

GloTek, Inc. www.globtek.com 186 Veterans Drive, Northvale, NJ 07647 Tel. (201) 784-1000 Fax (201) 784-0111	Drawing Title: GTM96180-1807-1.05-T3, ITE / Medical Power Supply/Class 2/Household Power Supply, Efficiency Level: USA DOE Level VI / Eco-design Directive 2009/125/EC, (EU) 2019/1782, Case Color/Style: GlobTek Black, Desktop/External, Regulated Switchmode AC-DC Power Supply AC Adaptor, Input Rating: 100-240V~, 50-60 Hz, IEC 60320/C14 , Output Rating: 18W, 5.95V@3.0A, Output Configuration: 1200 mm, 16/2 Cond, UL 2464, Female Barrel 5.5 * 2.5 * 11mm with internal Spring Clip and Locking Notch or Equal, Ferrite: None, GlobTek Black, GT Cord # C3338, Pin Out: Center Positive (+V), Blades/Input Cord: Not Applicable, Approvals: Taiwan BSMI; IP42; CB 62368; CB 60950; Class I; 230V CoC Tier 2; cULus (9V only); Korea (12V Only); EAC; Morocco; NOM (9V only); S-Mark 60950; ETL; CCC; CE; IRAM; CB 60335; cETLus UL1310; Fuse 60335; Fuse 60335; CE; China RoHS; Level VI; LPS 60950; RoHS;Ukraine; VCCI; WEEE; PSE; PSE; FCC; CAN ICES-3; cETLus; cETLus 60601-1 3rd; CB 60601-1; RCM;	
	Model No. GTM96180-1807-1.05-T3	
	Part No./Ordering No. TR9CB3000LCP-IM(R6B)	Rev A1

<a href="#">1191068F0701(R)</a>	N. American (Type B)	NEMA 5-15P Hospital	IEC 320/C13	2459	8
<a href="#">2194272M5701-T(R)</a>	Argentina (Type I)	IRAM 2073	IEC 320/C13	2500	8
<a href="#">5502022M5701A(R)</a>	Australian (Type I)	AS3112 / 3 PRONG	IEC 320/C13	2500	8
<a href="#">204B4272M5701(R)</a>	Brazil (Type N)	BRAZIL	IEC 320/C13	2500	8
<a href="#">6023602M5701(R)</a>	China (Type I)	CCC GR2099	IEC 320/C13	2500	8
<a href="#">G8014272M5701(R)</a>	Danish (Type K)	AFSNIT SECTION 107-2-D1	IEC 320/C13	2500	8
<a href="#">23144272M5701-T(R)</a>	Europe (Type E)	CEE 7/7	IEC 320/C13	2500	8
<a href="#">205IN4272M5701(R)</a>	India (Type D)	India IS 1293 (also known as IA16A3 or BS546)	IEC 320/C13	2500	8
<a href="#">208IN4272M5701(R)</a>	India (Type M)	India IS 1293 (also known as IA16A3 or BS546)	IEC320/C13	2500	8
<a href="#">377C4272M5701(R)</a>	Israel (Type H)	ISL 377C	IEC 320/C13	2500	8
<a href="#">23024272M5701(R)</a>	Italy (Type L)	CEI 23-16/VII	IEC 320/C13	2500	8
<a href="#">3003339F701(R)</a> [3x1.25mm2]	Japan (Type B)	JIS 8303 / 3 PINS	IEC 320/C13	2500	8
<a href="#">3003068F2701-HK(R)</a> [3 x 2.0mm2]					
<a href="#">302J115J6F0701J(R)</a>	Japan / North America (Type B – 12A)	JIS 8303 / 3 PINS and NEMA 5-15P (PSE and UL/CUL appr)	IEC 320/C13	1830	6
<a href="#">302J104J6F0701J(R)</a>	Japan / North America (Type B – 15A)	JIS 8303 / 3 PINS and NEMA 5-15P (PSE and UL/CUL appr)	IEC 320/C13	1830	6
<a href="#">2313K3432M5701(R)</a>	Korea (Type F)	KS C 8305	IEC 320/C13	2500	8
<a href="#">5804272M5701(R)</a>	Russia (Type F)	GOST 7396	IEC 320/C13	2500	8
<a href="#">2084272M5701(R)</a>	South Africa (Type M)	South Africa SABS164-1 (16A type)	IEC 320/C13	2500	8
<a href="#">23214272M5701(R)</a>	Switzerland (Type J)	SEV 1011	IEC 320/C13	2500	8
<a href="#">3003322M5701(R)</a>	Taiwan (Type B)	BSMI	IEC 320/C13	2500	8
<a href="#">PZ0800100-2M5BK13H(R)</a>	UK, Hong Kong, Singapore, Gulf States (Type G)	BS 1363A	IEC 320/C13	2500	8
<a href="#">7055002M5701A(R)</a>	International	IEC 320 C14-C13	IEC 320/C13	2500	8

<b>GlobTek, Inc.</b> www.globtek.com 186 Veterans Drive, Northvale, NJ 07647 Tel. (201) 784-1000 Fax (201) 784-0111	Drawing Title: GTM96180-1807-1.05-T3, ITE / Medical Power Supply/Class 2/Household Power Supply, Efficiency Level: USA DOE Level VI / Eco-design Directive 2009/125/EC, (EU) 2019/1782, Case Color/Style: GlobTek Black, Desktop/External, Regulated Switchmode AC-DC Power Supply AC Adaptor, Input Rating: 100-240V~, 50-60 Hz, IEC 60320/C14 , Output Rating: 18W, 5.95V@3.0A, Output Configuration: 1200 mm, 16/2 Cond, UL 2464, Female Barrel 5.5 * 2.5 * 11mm with internal Spring Clip and Locking Notch or Equal, Ferrite: None, GlobTek Black, GT Cord # C3338, Pin Out: Center Positive (+V), Blades/Input Cord: Not Applicable, Approvals: Taiwan BSMI; IP42; CB 62368; CB 60950; Class I; 230V CoC Tier 2; cULus (9V only); Korea (12V Only); EAC; Morocco; NOM (9V only); S-Mark 60950; ETL; CCC; CE; IRAM; CB 60335; cETLus UL1310; Fuse 60335; Fuse 60335; CE; China RoHS; Level VI; LPS 60950; RoHS;Ukraine; VCCI; WEEE; PSE; PSE; FCC; CAN ICES-3; cETLus; cETLus 60601-1 3rd; CB 60601-1; RCM;	
	Model No. GTM96180-1807-1.05-T3	
	Part No./Ordering No. TR9CB3000LCP-IM(R6B)	Rev A1

**OUTPUT CORD AND CONNECTOR: LCL/C3338**

ACTUAL CONNECTORS, OVERMOLDS, FERRITES MAY VARY SLIGHTLY FROM THE PICTURE BELOW

CABLE TYPE	UL 2464
CABLE LENGTH (mm)	1200
CABLE TOLERANCE (mm)	+/-50
WIRE GAUGE (AWG)	16
CONDUCTORS	2
HANK DIMENSION (mm)	120 ± 15
CABLE / CONNECTOR OVERMOLD COLOR	GlobTek Black
FERRITE TYPE / DIMENSION	None
FERRITE # OF TURNS(Definition)	N/A
FERRITE DIMENSION FROM STRAIN RELIEF	N/A
FERRITE DIMENSION FROM PLUG	N/A
PLUG TYPE	Female Barrel 5.5 * 2.5 * 11mm with internal Spring Clip and Locking Notch or Equal
OUTPUT CONNECTOR SEX	
OVERMOLDED	
OVER MOLD ORIENTATION	Straight
CONNECTOR PIN OUT:	Center Positive (+V)
ADDITIONAL REQUIREMENTS	

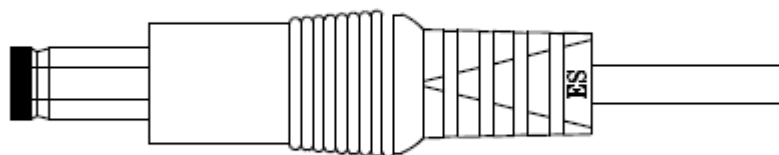

ADDITIONAL OUTPUT PLUG OPTIONS ARE AVAILABLE AT <https://www.globtek.com/connectors/>  
STANDARD PLUGS AND CONNECTORS CAN BE SEEN ONLINE AT <https://www.globtek.com/connectors/>

TO ADDRESS SYSTEM-LEVEL EMI CONCERNS, FERRITE CHOKES/BEADS MAY BE ADDED/REVISED UPON REQUEST. A SAMPLE KIT OF GLOBTEK'S STANDARD FERRITES IS AVAILABLE UNDER GLOBTEK P/N: EMI-MITIGATION-KIT1

FOR ADDITIONAL INFORMATION, PLEASE READ OUR WHITE PAPER AT:  
<https://en.globtek.com/technical-articles/ferrite-kit-radiated-emi-suppression-kit-for-globtek-power-supplies-cable-assemblies>

GloTek, Inc. www.globtek.com 186 Veterans Drive, Northvale, NJ 07647 Tel. (201) 784-1000 Fax (201) 784-0111	Drawing Title: GTM96180-1807-1.05-T3, ITE / Medical Power Supply/Class 2/Household Power Supply, Efficiency Level: USA DOE Level VI / Eco-design Directive 2009/125/EC, (EU) 2019/1782, Case Color/Style: GlobTek Black, Desktop/External, Regulated Switchmode AC-DC Power Supply AC Adaptor, Input Rating: 100-240V~, 50-60 Hz, IEC 60320/C14 , Output Rating: 18W, 5.95V@3.0A, Output Configuration: 1200 mm, 16/2 Cond, UL 2464, Female Barrel 5.5 * 2.5 * 11mm with internal Spring Clip and Locking Notch or Equal, Ferrite: None, GlobTek Black, GT Cord # C3338, Pin Out: Center Positive (+V), Blades/Input Cord: Not Applicable, Approvals: Taiwan BSMI; IP42; CB 62368; CB 60950; Class I; 230V CoC Tier 2; cULus (9V only); Korea (12V Only); EAC; Morocco; NOM (9V only); S-Mark 60950; ETL; CCC; CE; IRAM; CB 60335; cETLus UL1310; Fuse 60335; Fuse 60335; CE; China RoHS; Level VI; LPS 60950; RoHS;Ukraine; VCCI; WEEE; PSE; PSE; FCC; CAN ICES-3; cETLus; cETLus 60601-1 3rd; CB 60601-1; RCM;	
	Model No. GTM96180-1807-1.05-T3	
	Part No./Ordering No. TR9CB3000LCP-IM(R6B)	Rev A1

LABEL:L-1186

LABEL P/N:	Standard GT
MATERIAL:	Flat Thermal Transfer, Imprintable, Polyester Label and/or Pad Printed and/or Molded, and/or Laser Engraved in the case
BACKGROUND COLOR:	Black if housing is Black, White or Silver if housing is White or Gray.
TEXT COLOR:	White or Silver if label is Black Background for Black housing. Black if label is White or Silver background and Housing is White or Gray.
LABEL WIDTH (mm):	36.5
LABEL HEIGHT (mm):	48.5
SPECIAL BARCODE LABEL MATERIAL:	

Below is the minimum information which will appear on the label. NOTE: in the logo area additional/actual positioning of symbols and text is subjected to change as per agency updates/requirements or additional model approvals become available. Regulatory certifications/label markings may be in logo area on the label or molded into the case housing outside the label area. Information will be shown via label and/or pad printed and/or molded and/or laser engraved in the case. \* Date code markings at GlobTek option.

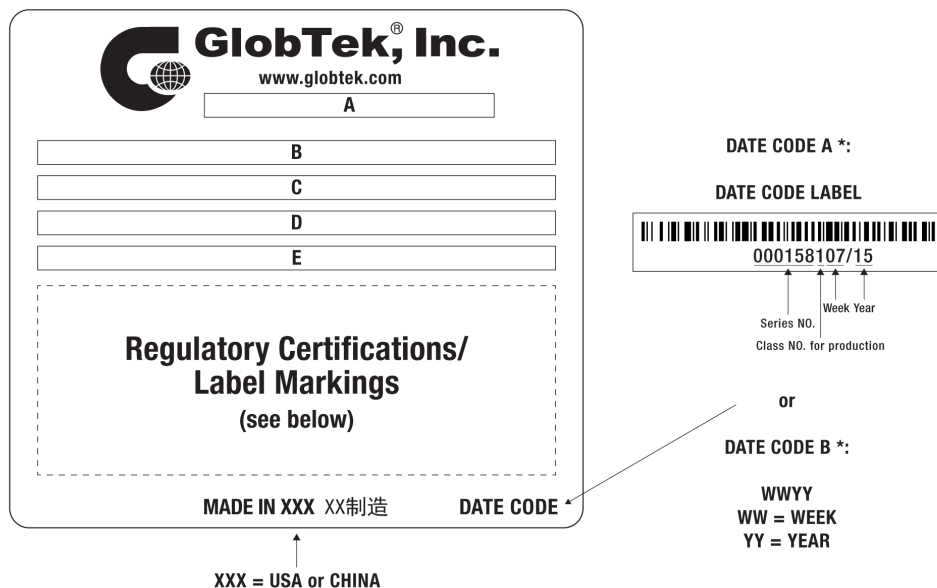

A=ITE / Medical Power Supply/Class 2/Household Power Supply  
B=P/N: (料号) TR9CB3000LCP-IM(R6B)  
C=Model (型号) GTM96180-1807-1.05-T3  
D=Input (输入)100-240V~, 50-60 Hz, 0.6 A  
E=Output (输出)5.95 V  $\equiv$  3.0 A, 18.0W

<b>GlobTek, Inc.</b> www.globtek.com 186 Veterans Drive, Northvale, NJ 07647 Tel. (201) 784-1000 Fax (201) 784-0111	Drawing Title: GTM96180-1807-1.05-T3, ITE / Medical Power Supply/Class 2/Household Power Supply, Efficiency Level: USA DOE Level VI / Eco-design Directive 2009/125/EC, (EU) 2019/1782, Case Color/Style: GlobTek Black, Desktop/External, Regulated Switchmode AC-DC Power Supply AC Adaptor, Input Rating: 100-240V~, 50-60 Hz, IEC 60320/C14 , Output Rating: 18W, 5.95V@3.0A, Output Configuration: 1200 mm, 16/2 Cond, UL 2464, Female Barrel 5.5 * 2.5 * 11mm with internal Spring Clip and Locking Notch or Equal, Ferrite: None, GlobTek Black, GT Cord # C3338, Pin Out: Center Positive (+V), Blades/Input Cord: Not Applicable, Approvals: Taiwan BSMI; IP42; CB 62368; CB 60950; Class I; 230V CoC Tier 2; cULus (9V only); Korea (12V Only); EAC; Morocco; NOM (9V only); S-Mark 60950; ETL; CCC; CE; IRAM; CB 60335; cETLus UL1310; Fuse 60335; Fuse 60335; CE; China RoHS; Level VI; LPS 60950; RoHS;Ukraine; VCCI; WEEE; PSE; PSE; FCC; CAN ICES-3; cETLus; cETLus 60601-1 3rd; CB 60601-1; RCM;	
	Model No. GTM96180-1807-1.05-T3	
	Part No./Ordering No. TR9CB3000LCP-IM(R6B)	Rev A1

AGENCY ONLINE DOCUMENTS	<a href="http://www.globtek.info/certs/GTM96180-TZ/">http://www.globtek.info/certs/GTM96180-TZ/</a>
CE EC-Declaration for Medical	<a href="http://globtek.force.com/models/ec_declaration_product?id=01ta0000006xR1J&amp;m=1">http://globtek.force.com/models/ec_declaration_product?id=01ta0000006xR1J&amp;m=1</a>
CE EC-Declaration for Industrial/Commercial/ITE	<a href="http://globtek.force.com/models/ec_declaration_product?id=01ta0000006xR1J&amp;i=3">http://globtek.force.com/models/ec_declaration_product?id=01ta0000006xR1J&amp;i=3</a>
CE EC-Declaration for Household	<a href="http://globtek.force.com/models/ec_declaration_product?id=01ta0000006xR1J&amp;h=3">http://globtek.force.com/models/ec_declaration_product?id=01ta0000006xR1J&amp;h=3</a>
Morocco SDoC Declaration	<a href="https://globtek.secure.force.com/models/Morocco_SDoC_Declaration?id=a00a000000MmbDvEAJ">https://globtek.secure.force.com/models/Morocco_SDoC_Declaration?id=a00a000000MmbDvEAJ</a>
RoHS/RoHS3 Declaration	<a href="https://www.globtek.com/pdf/rohs_cert/01ta0000006xR1JAAU">https://www.globtek.com/pdf/rohs_cert/01ta0000006xR1JAAU</a>
REACH Declaration	<a href="https://www.globtek.com/pdf/iso_certificates/REACH.pdf">https://www.globtek.com/pdf/iso_certificates/REACH.pdf</a>
Conflict Minerals Declaration	<a href="https://www.globtek.com/pdf/conflict-minerals.pdf">https://www.globtek.com/pdf/conflict-minerals.pdf</a>

IPXY rating is based on 3rd party testing and customers should check suitability and test system level IPXY rating before ordering.

## Regulatory Certifications/Label Markings

LATEST PRODUCT/MODEL CERTIFICATIONS: <http://en.globtek.com/datasheet/id/a00a000000MmbDv>

AGENCY ONLINE DOCUMENTS: <http://www.globtek.info/certs/GTM96180-TZ/>



(E1) Earthed output

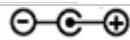

Center Positive (+V)

<b>GlobTek, Inc.</b> www.globtek.com 186 Veterans Drive, Northvale, NJ 07647 Tel. (201) 784-1000 Fax (201) 784-0111	Drawing Title: GTM96180-1807-1.05-T3, ITE / Medical Power Supply/Class 2/Household Power Supply, Efficiency Level: USA DOE Level VI / Eco-design Directive 2009/125/EC, (EU) 2019/1782, Case Color/Style: GlobTek Black, Desktop/External, Regulated Switchmode AC-DC Power Supply AC Adaptor, Input Rating: 100-240V~, 50-60 Hz, IEC 60320/C14 , Output Rating: 18W, 5.95V@3.0A, Output Configuration: 1200 mm, 16/2 Cond, UL 2464, Female Barrel 5.5 * 2.5 * 11mm with internal Spring Clip and Locking Notch or Equal, Ferrite: None, GlobTek Black, GT Cord # C3338, Pin Out: Center Positive (+V), Blades/Input Cord: Not Applicable, Approvals: Taiwan BSMI; IP42; CB 62368; CB 60950; Class I; 230V CoC Tier 2; cULus (9V only); Korea (12V Only); EAC; Morocco; NOM (9V only); S-Mark 60950; ETL; CCC; CE; IRAM; CB 60335; cETLus UL1310; Fuse 60335; Fuse 60335; CE; China RoHS; Level VI; LPS 60950; RoHS;Ukraine; VCCI; WEEE; PSE; PSE; FCC; CAN ICES-3; cETLus; cETLus 60601-1 3rd; CB 60601-1; RCM;	
	Model No. GTM96180-1807-1.05-T3	
	Part No./Ordering No. TR9CB3000LCP-IM(R6B)	Rev A1

## PACKAGING

Packing Spec P/N:	Standard DT, Individually Box, GT User Manual
Box Qty:	60
Gift Box Size (mm):	147*100*33
Gift Box Color:	White
Master Carton Size (mm):	465 x 415 x 225
Master Carton Cubic Volume (m³):	0.04
Master GW (Kg):	15.4 kg
BLADES INCLUDED:	N/A:
BLADE/CORD INSTALLED:	N/A:
USER MANUAL:	809-DESKTOPUSERMANUAL on A4 paper
USER MANUAL WEB LINK:	<a href="https://en.globtek.com/pdf/809-DESKTOPUSERMANUA...">https://en.globtek.com/pdf/809-DESKTOPUSERMANUA...</a>

If specific packaging is required, this section must specify all requirements and note "no exceptions". If this section does not specify packaging, it is subject to change without notice at GlobTek's discretion

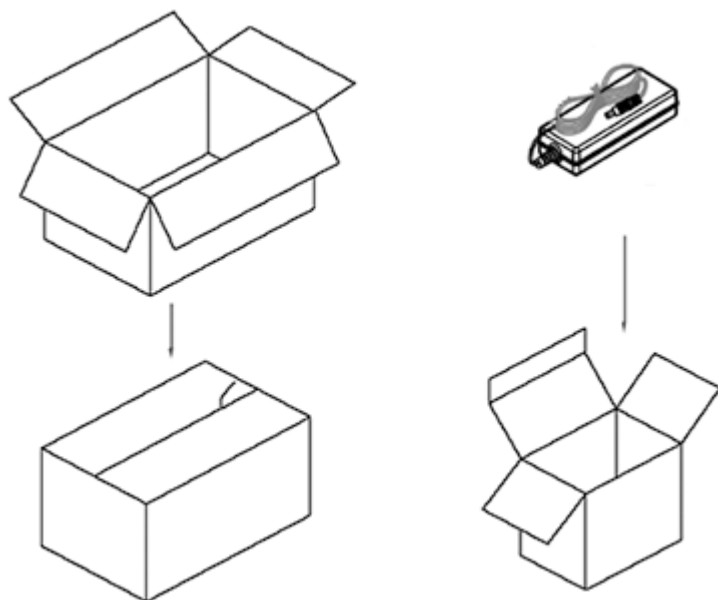

### PROPRIETARY INFORMATION

GloTek, Inc. www.globtek.com 186 Veterans Drive, Northvale, NJ 07647 Tel. (201) 784-1000 Fax (201) 784-0111	Drawing Title: GTM96180-1807-1.05-T3, ITE / Medical Power Supply/Class 2/Household Power Supply, Efficiency Level: USA DOE Level VI / Eco-design Directive 2009/125/EC, (EU) 2019/1782, Case Color/Style: GlobTek Black, Desktop/External, Regulated Switchmode AC-DC Power Supply AC Adaptor, Input Rating: 100-240V~, 50-60 Hz, IEC 60320/C14 , Output Rating: 18W, 5.95V@3.0A, Output Configuration: 1200 mm, 16/2 Cond, UL 2464, Female Barrel 5.5 * 2.5 * 11mm with internal Spring Clip and Locking Notch or Equal, Ferrite: None, GlobTek Black, GT Cord # C3338, Pin Out: Center Positive (+V), Blades/Input Cord: Not Applicable, Approvals: Taiwan BSMI; IP42; CB 62368; CB 60950; Class I; 230V CoC Tier 2; cULus (9V only); Korea (12V Only); EAC; Morocco; NOM (9V only); S-Mark 60950; ETL; CCC; CE; IRAM; CB 60335; cETLus UL1310; Fuse 60335; Fuse 60335; CE; China RoHS; Level VI; LPS 60950; RoHS;Ukraine; VCCI; WEEE; PSE; PSE; FCC; CAN ICES-3; cETLus; cETLus 60601-1 3rd; CB 60601-1; RCM;	
	Model No. GTM96180-1807-1.05-T3	
	Part No./Ordering No. TR9CB3000LCP-IM(R6B)	Rev A1

## INSTRUCTIONS TO THE OEM SYSTEMS ENGINEER

It is the responsibility of the OEM systems engineer to provide the end system user instructions and warnings for the use of this product in the end system.

If an input cord is required for this product, AC Mains voltage should be provided to the power supply by a power supply cord approved to the national standards of the country in which it will be used.

This power supply is not designed to be repaired. No serviceable parts inside. A blown internal fuse is an indication of catastrophic failure of circuit component(s). If a Failure Analysis is required for a failed power supply/battery charger, please return the damaged unit to Globtek for an accurate determination of the root cause of the failure.

EMC Compliance of the complete OEM product, including the GlobTek power supply/battery charger needs to be verified by the OEM systems engineer.

## INSTRUCTION SHEET

N/A

### PROPRIETARY INFORMATION