

GloTek, Inc. www.globtek.com 186 Veterans Drive, Northvale, NJ 07647 Tel. (201) 784-1000 Fax (201) 784-0111	Drawing Title: GTM96300-3619.5-4.5-R2, ITE / Medical Power Supply/Class 2/Household Power Supply, Efficiency Level: USA DOE Level VI / Eco-design Directive 2009/125/EC, (EU) 2019/1782, Case Color/Style: GlobTek Black, Wall Plug-in+Desktop Combination, Regulated Switchmode AC-DC Power Supply AC Adaptor, Input Rating: 100-240V~, 50-60 Hz, IEC 60320/C8 w/ Wall Blades Option , Output Rating: 36W, 15.0V@2.4A, Output Configuration: 1200 mm, 16/2 Cond. Round Black, T-plug system (includes 5.5x2.5, 5.5x2.1, 3.5x1.3mm plugs in each kit), Ferrite: None, GlobTek Black, GT Cord # C4257, Pin Out: Polarity Configuration T00 All plugs are Medical Grade, Locking, Polarized once installed, and single use only. Product demonstration link: https://en.globtek.com/news/t00-changeable-output-plug-system-for-power-supplies MOLDED CONNECTORS AVAILABLE, Blades/Input Cord: R-Series 1-15P North America, Approvals: CCC; Korea (12-14.9V Only); ETL; LPS 60950; CAN ICES-3; CB 62368; CB 60950; ETL 1310; ETL; 230V CoC Tier 2; EAC; cETLus 60950-1; UL 1310; cETLus 60601-1-11; NOM (5,7.5,12,15,19,24,48V only); IP40; ETL 62368; Morocco; RCM; RCM; FCC; S-Mark 60950; Double Insulation; LPS 62368; CE; CE; CB 60335; S-Mark IEC/EN 60601-1; CE; China RoHS; Level VI; RoHS; Ukraine; VCCI; WEEE; PSE; PSE; PSE; CB 60601-1;	
	Model No. GTM96300-3619.5-4.5-R2	
	Part No./Ordering No. RR9KG2400T00NAIMR6B	Rev D

REVISION HISTORY

REV	DESCRIPTION	SUB	DATE	APPROVED
D	Update RoHS 2 to RoHS, Ukraine UKRSeopro, CCC.Add ETL,EAC.		08/22/2018	QA
C	Updating engineering model from GTM96300-3019.5-4.5-R2 to GTM96300-3619.5-4.5-R2		12/21/2016	QA
B	Update Polarity configuration on Manual instruction and O/P cord		10/28/2016	QA
A	Initial release.		10/06/2016	QA

In Addition to GlobTek Inc.'s renewed ISO9001:2015 - Quality Management System Certification, GlobTek Inc. is now certified to:

ISO13485:2016 - Medical Devices Quality Management System Certification

ISO14001:2015 - Environmental Management System Certification

ISO Certificates are available online at <https://www.globtek.com/iso-certificates/>

Customer Approval of Specification:

Please approve, sign and send back to GlobTek so we can complete order processing.

A delay in receipt of this form will delay delivery schedule.

Company Name:

Customer P/N:

Quote Number:

Date:

Authorized Representative Name:

Authorized Representative Signature:

The acceptance of this specification and use of the product described in this document indicates the acceptance and binding of the customer to Globtek terms and conditions, which supersede all other agreements, terms, and conditions (<https://en.globtek.com/terms-and-conditions/>).

The purchaser of this product (Customer) agrees that it is their sole responsibility to determine suitability/fitness of the product described in this specification for their application and to take precautions for protection against any hazards attendant to the handling and use of the product.

Footnote:

GlobTek Inc. will not be liable for the safety and performance of these power supplies if unauthorized access and repair occurs. End user should consult applicable UL, CSA or EN standards for proper installation instruction.

Limitation of Use:

GlobTek products are intended for use with commercial, medical, and/or industrial equipment only. GlobTek product are not authorized for use as mission critical components in life support hazardous environment, nuclear or aircraft applications without prior written approval from the CEO of GlobTek Inc.

Contents of this document are subject to change without prior notice.

GlobTek, Inc. www.globtek.com 186 Veterans Drive, Northvale, NJ 07647 Tel. (201) 784-1000 Fax (201) 784-0111	Drawing Title: GTM96300-3619.5-4.5-R2, ITE / Medical Power Supply/Class 2/Household Power Supply, Efficiency Level: USA DOE Level VI / Eco-design Directive 2009/125/EC, (EU) 2019/1782, Case Color/Style: GlobTek Black, Wall Plug-in+Desktop Combination, Regulated Switchmode AC-DC Power Supply AC Adaptor, Input Rating: 100-240V~, 50-60 Hz, IEC 60320/C8 w/ Wall Blades Option , Output Rating: 36W, 15.0V@2.4A, Output Configuration: 1200 mm, 16/2 Cond. Round Black, T-plug system (includes 5.5x2.5, 5.5x2.1, 3.5x1.3mm plugs in each kit), Ferrite: None, GlobTek Black, GT Cord # C4257, Pin Out: Polarity Configuration T00 All plugs are Medical Grade, Locking, Polarized once installed, and single use only. Product demonstration link: https://en.globtek.com/news/t00-changeable-output-plug-system-for-power-supplies MOLDED CONNECTORS AVAILABLE, Blades/Input Cord: R-Series 1-15P North America, Approvals: CCC; Korea (12-14.9V Only); ETL; LPS 60950; CAN ICES-3; CB 62368; CB 60950; ETL 1310; ETL; 230V CoC Tier 2; EAC; cETLus 60950-1; UL 1310; cETLus 60601-1-11; NOM (5,7.5,12,15,19,24,48V only); IP40; ETL 62368; Morocco; RCM; RCM; FCC; S-Mark 60950; Double Insulation; LPS 62368; CE; CE; CB 60335; S-Mark IEC/EN 60601-1; CE; China RoHS; Level VI; RoHS; Ukraine; VCCI; WEEE; PSE; PSE; PSE; CB 60601-1;
	Model No. GTM96300-3619.5-4.5-R2 Part No./Ordering No. RR9KG2400T00NAIMR6B
	Rev D

POWER SUPPLY INFORMATION

TYPE:	Wall Plug-in+Desktop Combination
TECHNOLOGY:	Regulated Switchmode AC-DC Power Supply AC Adaptor
CASE COLOR:	GlobTek Black
NAMEPLATE RATED INPUT:	100-240V~, 50-60 Hz, 1A
INPUT CONFIG:	IEC 60320/C8 w/ Wall Blades Option
WATTS:	36.0
VOLTS OUT:	15.0
CURRENT OUT (Amps):	2.4
INGRESS PROTECTION:	IP40 (cord), IP52(R-blades)
GROUNDING CONFIGURATION:	(F1) Class II / Double Insulated
EFFICIENCY LEVEL:	
OUTPUT CONFIGURATION:	1200 mm, 16/2 Cond, Round Black, T-plug system (includes 5.5x2.5, 5.5x2.1, 3.5x1.3mm plugs in each kit), Ferrite: None, GlobTek Black, GT Cord # C4257
OVERMOLDED:	No
OUTPUT CONNECTOR GENDER:	not applicable
CONNECTOR PIN OUT:	Polarity Configuration T00 All plugs are Medical Grade, Locking, Polarized once installed, and single use only. Product demonstration link: https://en.globtek.com/news/t00-changeable-output-plug-system-for-power-supplies MOLDED CONNECTORS AVAILABLE
LABEL SPECS:	Standard GT,L-1186
SPECIAL BARCODE LABEL	
MATERIAL:	
PACK SPEC:	
USER MANUAL:	

PROPRIETARY INFORMATION

<p>GlobTek, Inc. www.globtek.com 186 Veterans Drive, Northvale, NJ 07647 Tel. (201) 784-1000 Fax (201) 784-0111</p>	<p>Drawing Title: GTM96300-3619.5-4.5-R2, ITE / Medical Power Supply/Class 2/Household Power Supply, Efficiency Level: USA DOE Level VI / Eco-design Directive 2009/125/EC, (EU) 2019/1782, Case Color/Style: GlobTek Black, Wall Plug-in+Desktop Combination, Regulated Switchmode AC-DC Power Supply AC Adaptor, Input Rating: 100-240V~, 50-60 Hz, IEC 60320/C8 w/ Wall Blades Option , Output Rating: 36W, 15.0V@2.4A, Output Configuration: 1200 mm, 16/2 Cond. Round Black, T-plug system (includes 5.5x2.5, 5.5x2.1, 3.5x1.3mm plugs in each kit), Ferrite: None, GlobTek Black, GT Cord # C4257, Pin Out: Polarity Configuration T00 All plugs are Medical Grade, Locking, Polarized once installed, and single use only. Product demonstration link: https://en.globtek.com/news/t00-changeable-output-plug-system-for-power-supplies MOLDED CONNECTORS AVAILABLE, Blades/Input Cord: R-Series 1-15P North America, Approvals: CCC; Korea (12-14.9V Only); ETL; LPS 60950; CAN ICES-3; CB 62368; CB 60950; ETL 1310; ETL; 230V CoC Tier 2; EAC; cETLus 60950-1; UL 1310; cETLus 60601-1-11; NOM (5,7.5,12,15,19,24,48V only); IP40; ETL 62368; Morocco; RCM; RCM; FCC; S-Mark 60950; Double Insulation; LPS 62368; CE; CE; CB 60335; S-Mark IEC/EN 60601-1; CE; China RoHS; Level VI; RoHS; Ukraine; VCCL; WEEE; PSE; PSE; PSE; CB 60601-1;</p>	
	<p>Model No. GTM96300-3619.5-4.5-R2</p>	
	<p>Part No./Ordering No. RR9KG2400T00NAIMR6B</p>	<p>Rev D</p>

Notes/Modifications/Customizations (notes in this section supersede the values shown in the standard spec):
DIMENSIONS ARE IN MM UNLESS SPECIFIED OTHERWISE.

Â

<p>GlobTek, Inc. www.globtek.com 186 Veterans Drive, Northvale, NJ 07647 Tel. (201) 784-1000 Fax (201) 784-0111</p>	<p>Drawing Title: GTM96300-3619.5-4.5-R2, ITE / Medical Power Supply/Class 2/Household Power Supply, Efficiency Level: USA DOE Level VI / Eco-design Directive 2009/125/EC, (EU) 2019/1782, Case Color/Style: GlobTek Black, Wall Plug-in+Desktop Combination, Regulated Switchmode AC-DC Power Supply AC Adaptor, Input Rating: 100-240V~, 50-60 Hz, IEC 60320/C8 w/ Wall Blades Option , Output Rating: 36W, 15.0V@2.4A, Output Configuration: 1200 mm, 16/2 Cond. Round Black, T-plug system (includes 5.5x2.5, 5.5x2.1, 3.5x1.3mm plugs in each kit), Ferrite: None, GlobTek Black, GT Cord # C4257, Pin Out: Polarity Configuration T00 All plugs are Medical Grade, Locking, Polarized once installed, and single use only. Product demonstration link: https://en.globtek.com/news/100-changeable-output-plug-system-for-power-supplies MOLDED CONNECTORS AVAILABLE, Blades/Input Cord: R-Series 1-15P North America, Approvals: CCC; Korea (12-14.9V Only); ETL; LPS 60950; CAN ICES-3; CB 62368; CB 60950; ETL 1310; ETL; 230V CoC Tier 2; EAC; cETLus 60950-1; UL 1310; cETLus 60601-1-11; NOM (5,7.5,12,15,19,24,48V only); IP40; ETL 62368; Morocco; RCM; RCM; FCC; S-Mark 60950; Double Insulation; LPS 62368; CE; CE; CB 60335; S-Mark IEC/EN 60601-1; CE; China RoHS; Level VI; RoHS; Ukraine; VCCE; WEEE; PSE; PSE; PSE; CB 60601-1;</p>
	<p>Model No. GTM96300-3619.5-4.5-R2</p>
<p>Part No./Ordering No. RR9KG2400T00NAIMR6B</p>	<p>Rev D</p>

ELECTRICAL SPECIFICATIONS

A) ELECTRICAL SPECIFICATIONS:

01. Input Voltage: Specified 90-264 Vac, Nameplate rated: 100-240Vac
 - 90-264 Vac range @ 100% of rated load current
 - 85-264 Vac range @ 85% of rated load current
 - 110-370 VDC range @ 100% of rated load current
02. Input Frequency: Specified 47-63 Hz, Nameplate rated 50-60Hz
03. Output Regulation: +/- 5% measured at the output connector
04. Line Voltage Regulation: +/- 0.5% typical measured at full load
05. Green Power On Indicator LED
06. Output Ripple (Vp-p): 1% or 100 mV whichever is greater, measured at 20 MHz bandwidth with 0.1 uf ceramic capacitor in parallel with a low impedance 47 uf electrolytic capacitor connected at the end of the output connector
07. Turn-ON/OFF Overshoot: 5% maximum, 1 mS typical recovery time for 40% to 70% step load
08. Turn-ON Delay: 1 second maximum @ full load, nominal line
09. Hold-Up Time: 8 mS typical @ nominal input voltage and full load
10. Inrush Current: 30A/60A maximum cold start @ 115/230Vac input
11. Efficiency: Compliant with Efficiency Level VI and CoC Tier 2 standards
12. No Load Standby Power: <0.075 W @ 230Vac

B) PROTECTION

01. Input Protection: Input line fusing and 300Vac MOV
02. Short Circuit/ Overload: Electronically Protected unit will auto recover upon removal of fault
 - Output Current Limit: 110% to 160% of rated output current
 - (upper end of current limit range is determined by normal output power rating, not derated output power level)
03. Output Over-Voltage: 110% to 130% of nominal output voltage

C) SAFETY

01. Dielectric Withstand Voltage: 4000Vac or 5656Vdc from input to output, On Class I models, 3000Vac or 4242Vdc from input to earth
02. Earth Leakage Current: Class I models < 300uA, N/A for Class II models
03. Touch Current: Class I models < 20uA, Class II models < 75uA
04. Earth Continuity Test: < 0.1 Ohm between Earth Pin at AC input and PCB termination point (Class I models only)
05. Means of Protection: 2 x MOPP
06. Compliant Standards: See listings at end of this drawing for specifics
07. [Output Isolation Options:](#)
 - a) C8 or C18 Inlet, Class II
 - b) C6 or C14 Inlet, Class II FE, Output Isolated from Earth contact
 - c) C6 or C14 Inlet, Class I, Output negative directly attached to Earth contact

D) EMC

EN 60601-1-2, 4th edition
 Emissions, per EN 55032, EN 61000-6-3, EN 61000-6-4, CISPR11 and CISPR22
 Conducted Emissions: Class B, FCC Part 15, Class B
 Radiated Emissions: Class B, FCC Part 15, Class B
 Line Frequency Harmonics EN61000-3-2, Class A

PROPRIETARY INFORMATION

<p>GlobTek, Inc. www.globtek.com 186 Veterans Drive, Northvale, NJ 07647 Tel. (201) 784-1000 Fax (201) 784-0111</p>	<p>Drawing Title: GTM96300-3619.5-4.5-R2, ITE / Medical Power Supply/Class 2/Household Power Supply, Efficiency Level: USA DOE Level VI / Eco-design Directive 2009/125/EC, (EU) 2019/1782, Case Color/Style: GlobTek Black, Wall Plug-in+Desktop Combination, Regulated Switchmode AC-DC Power Supply AC Adaptor, Input Rating: 100-240V~, 50-60 Hz, IEC 60320/C8 w/ Wall Blades Option , Output Rating: 36W, 15.0V@2.4A, Output Configuration: 1200 mm, 16/2 Cond. Round Black, T-plug system (includes 5.5x2.5, 5.5x2.1, 3.5x1.3mm plugs in each kit), Ferrite: None, GlobTek Black, GT Cord # C4257, Pin Out: Polarity Configuration T00 All plugs are Medical Grade, Locking, Polarized once installed, and single use only. Product demonstration link: https://en.globtek.com/news/t00-changeable-output-plug-system-for-power-supplies MOLDED CONNECTORS AVAILABLE, Blades/Input Cord: R-Series 1-15P North America, Approvals: CCC; Korea (12-14.9V Only); ETL; LPS 60950; CAN ICES-3; CB 62368; CB 60950; ETL 1310; ETL; 230V CoC Tier 2; EAC; cETLus 60950-1; UL 1310; cETLus 60601-1-11; NOM (5,7.5,12,15,19,24,48V only); IP40; ETL 62368; Morocco; RCM; RCM; FCC; S-Mark 60950; Double Insulation; LPS 62368; CE; CE; CB 60335; S-Mark IEC/EN 60601-1; CE; China RoHS; Level VI; RoHS; Ukraine; VCCI; WEEE; PSE; PSE; PSE; CB 60601-1;</p>
	<p>Model No. GTM96300-3619.5-4.5-R2</p>
	<p>Part No./Ordering No. RR9KG2400T00NAIMR6B</p>

Rev D

Voltage Fluctuations/Flicker EN61000-3-3

Immunity, per EN 55024, EN 61000-6-1, EN 61000-6-2

Static Discharge Immunity EN61000-4-2, 10kV Contact Discharge, 20kV air discharge

Radiated RF Immunity EN61000-4-3, 10V/m 80-1000MHz, 3V/m 1-2.7GHz, 80% 1KHz AM.

EFT/Burst Immunity EN61000-4-4, 4kV/100kHz.

Line Surge Immunity EN61000-4-5, 2kV differential, 4kV common-mode

Conducted RF Immunity EN61000-4-6, 3Vrms, 80% 1KHz AM

Power Frequency Magnetic Field Immunity EN61000-4-8, 3A/m

Voltage Dip Immunity EN61000-4-11, Criteria

E) OTHER:

01. MTBF: 1,000,000 Hours @ 40°C ambient temperature, Full Load

02. GTM96300 Family: -10°C to 40°C ambient temperature with full load

Regarding Operating Temperature,

a- See below derating table for output power capability at alternate temperature

b- Extended low end temperature range available as custom option

03. Operating Humidity: 0% to 95% relative humidity, non-condensing

04. Storage Temperature: -30°C to 80°C

05. Operating Altitude: 5000 Meters

06. ROHS: Compliant with latest regulations, see approvals section below

F) ENCLOSURE

01. Housing: High impact plastic, 94V0 polycarbonate, non-vented

02. Markings: Label or Laser Printed

03. AC Input mechanical options: Desktop C6, C8, C14 or C18 IEC Inlet.

Hybrid option (Desktop or Changeable Blade Wall Plug-in) Class I or Class II input

G) SPECIAL OPTIONS

01. Cost reduction, removal of LED

02. Custom Cordsets, various cordage types, and connector types

03. Custom Markings

04. Short term Output Surge Capability

05. Reduced Leakage Current versions

06. Tightened output voltage tolerance

07. Reduced output ripple level

08. Reduced output power rating marking

09. High Rel PCB laminate with Plated through Holes for IPC610 Class 2 Compliance

10. Special Housing Colors and Cordset Colors

11. Quasi Constant Current Output, for Battery Charger Applications

12. Back EMF applications, custom solutions. For unusual motor load aps and other high inductance reverse energy flow requirements

13. Improved Ingress Protection Rating

<p>GlobTek, Inc. www.globtek.com 186 Veterans Drive, Northvale, NJ 07647 Tel. (201) 784-1000 Fax (201) 784-0111</p>	<p>Drawing Title: GTM96300-3619.5-4.5-R2, ITE / Medical Power Supply/Class 2/Household Power Supply, Efficiency Level: USA DOE Level VI / Eco-design Directive 2009/125/EC, (EU) 2019/1782, Case Color/Style: GlobTek Black, Wall Plug-in+Desktop Combination, Regulated Switchmode AC-DC Power Supply AC Adaptor, Input Rating: 100-240V~, 50-60 Hz, IEC 60320/C8 w/ Wall Blades Option , Output Rating: 36W, 15.0V@2.4A, Output Configuration: 1200 mm, 16/2 Cond. Round Black, T-plug system (includes 5.5x2.5, 5.5x2.1, 3.5x1.3mm plugs in each kit), Ferrite: None, GlobTek Black, GT Cord # C4257, Pin Out: Polarity Configuration T00 All plugs are Medical Grade, Locking, Polarized once installed, and single use only. Product demonstration link: https://en.globtek.com/news/100-changeable-output-plug-system-for-power-supplies MOLDED CONNECTORS AVAILABLE, Blades/Input Cord: R-Series 1-15P North America, Approvals: CCC; Korea (12-14.9V Only); ETL; LPS 60950; CAN ICES-3; CB 62368; CB 60950; ETL 1310; ETL; 230V CoC Tier 2; EAC; cETLus 60950-1; UL 1310; cETLus 60601-1-11; NOM (5,7.5,12,15,19,24,48V only); IP40; ETL 62368; Morocco; RCM; RCM; FCC; S-Mark 60950; Double Insulation; LPS 62368; CE; CE; CB 60335; S-Mark IEC/EN 60601-1; CE; China RoHS; Level VI; RoHS; Ukraine; VCCE; WEEE; PSE; PSE; PSE; CB 60601-1;</p>	
	<p>Model No. GTM96300-3619.5-4.5-R2</p>	
	<p>Part No./Ordering No. RR9KG2400T00NAIMR6B</p>	<p>Rev D</p>

TO ADDRESS SYSTEM-LEVEL EMI CONCERNS, FERRITE CHOKES/BEADS MAY BE ADDED/REVISED UPON REQUEST. A SAMPLE KIT OF GLOBTEK'S STANDARD FERRITES IS AVAILABLE UNDER GLOBTEK P/N: EMI-MITIGATION-KIT1

FOR ADDITIONAL INFORMATION, PLEASE READ OUR WHITE PAPER AT:

<https://en.globtek.com/technical-articles/ferrite-kit-radiated-emi-suppression-kit-for-globtek-power-supplies-cable-assemblies>

INGRESS PROTECTION: IP40 (cord), IP52(R-blades)

GlobTek, Inc.
 www.globtek.com
 186 Veterans Drive,
 Northvale, NJ 07647
 Tel. (201) 784-1000
 Fax (201) 784-0111

Drawing Title: GTM96300-3619.5-4.5-R2, ITE / Medical Power Supply/Class 2/Household Power Supply, Efficiency Level: USA DOE Level VI / Eco-design Directive 2009/125/EC, (EU) 2019/1782, Case Color/Style: GlobTek Black, Wall Plug-in+Desktop Combination, Regulated Switchmode AC-DC Power Supply AC Adaptor, Input Rating: 100-240V~, 50-60 Hz, IEC 60320/C8 w/ Wall Blades Option , Output Rating: 36W, 15.0V@2.4A, Output Configuration: 1200 mm, 16/2 Cond. Round Black, T-plug system (includes 5.5x2.5, 5.5x2.1, 3.5x1.3mm plugs in each kit), Ferrite: None, GlobTek Black, GT Cord # C4257, Pin Out: Polarity Configuration T00 All plugs are Medical Grade, Locking, Polarized once installed, and single use only. Product demonstration link: <https://en.globtek.com/news/100-changeable-output-plug-system-for-power-supplies> MOLDED CONNECTORS AVAILABLE, Blades/Input Cord: R-Series 1-15P North America, Approvals: CCC; Korea (12-14.9V Only); ETL; LPS 60950; CAN ICES-3; CB 62368; CB 60950; ETL 1310; ETL; 230V CoC Tier 2; EAC; cETLus 60950-1; UL 1310; cETLus 60601-1-11; NOM (5,7.5,12,15,19,24,48V only); IP40; ETL 62368; Morocco; RCM; RCM; FCC; S-Mark 60950; Double Insulation; LPS 62368; CE; CE; CB 60335; S-Mark IEC/EN 60601-1; CE; China RoHS; Level VI; RoHS; Ukraine; VCCL; WEEE; PSE; PSE; PSE; CB 60601-1;

Model No. GTM96300-3619.5-4.5-R2

Part No./Ordering No. RR9KG2400T00NAIMR6B

Rev D

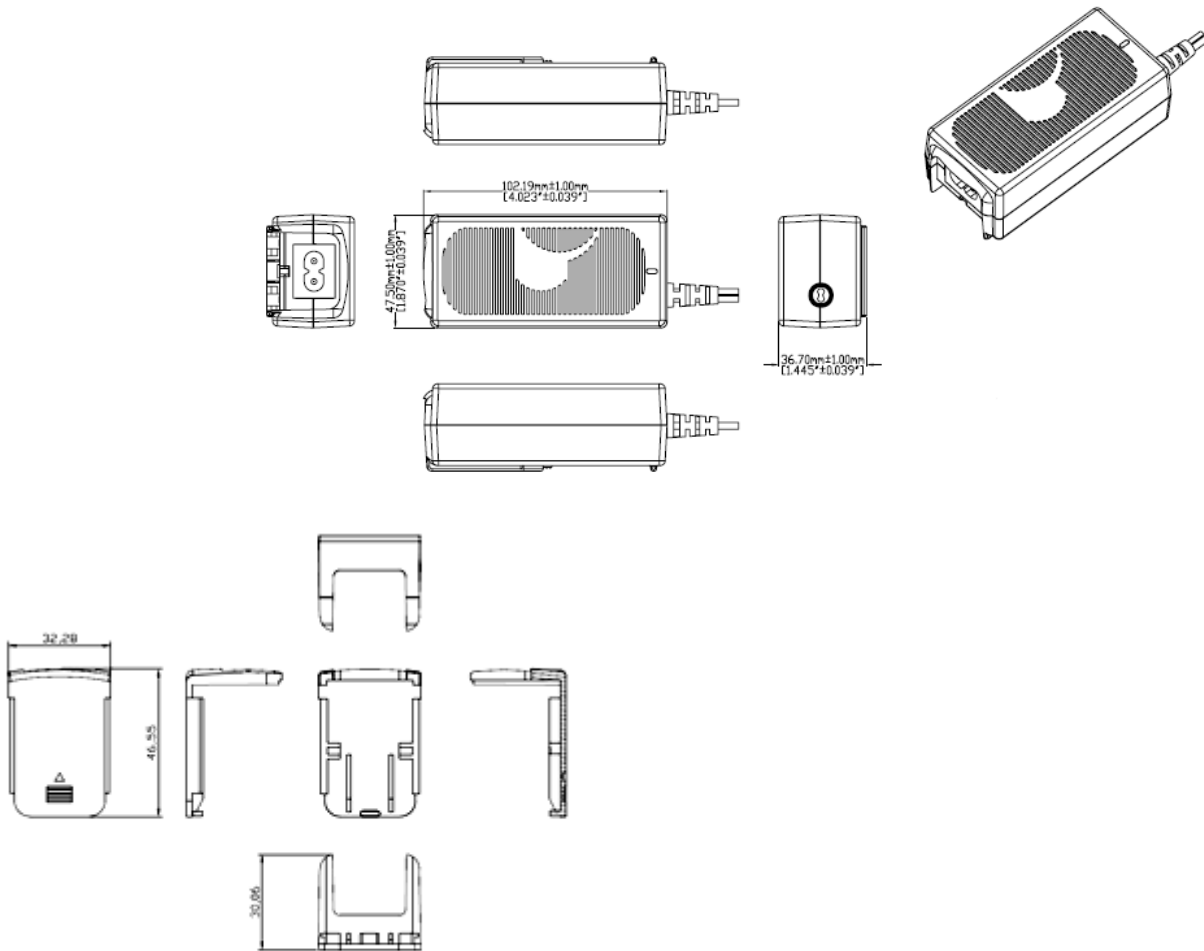

Units shipped without an installed input plug
 have a "desktop insert" installed.

GlobTek, Inc.
 www.globtek.com
 186 Veterans Drive,
 Northvale, NJ 07647
 Tel. (201) 784-1000
 Fax (201) 784-0111

Drawing Title: GTM96300-3619.5-4.5-R2, ITE / Medical Power Supply/Class 2/Household Power Supply, Efficiency Level: USA DOE Level VI / Eco-design Directive 2009/125/EC, (EU) 2019/1782, Case Color/Style: GlobTek Black, Wall Plug-in+Desktop Combination, Regulated Switchmode AC-DC Power Supply AC Adaptor, Input Rating: 100-240V~, 50-60 Hz, IEC 60320/C8 w/ Wall Blades Option , Output Rating: 36W, 15.0V@2.4A, Output Configuration: 1200 mm, 16/2 Cond. Round Black, T-plug system (includes 5.5x2.5, 5.5x2.1, 3.5x1.3mm plugs in each kit), Ferrite: None, GlobTek Black, GT Cord # C4257, Pin Out: Polarity Configuration T00 All plugs are Medical Grade, Locking, Polarized once installed, and single use only. Product demonstration link: <https://en.globtek.com/news/100-changeable-output-plug-system-for-power-supplies> MOLDED CONNECTORS AVAILABLE, Blades/Input Cord: R-Series 1-15P North America, Approvals: CCC; Korea (12-14.9V Only); ETL; LPS 60950; CAN ICES-3; CB 62368; CB 60950; ETL 1310; ETL; 230V CoC Tier 2; EAC; cETLus 60950-1; UL 1310; cETLus 60601-1-11; NOM (5,7.5,12,15,19,24,48V only); IP40; ETL 62368; Morocco; RCM; RCM; FCC; S-Mark 60950; Double Insulation; LPS 62368; CE; CE; CB 60335; S-Mark IEC/EN 60601-1; CE; China RoHS; Level VI; RoHS; Ukraine; VCCE; WEEE; PSE; PSE; PSE; CB 60601-1;

Model No. GTM96300-3619.5-4.5-R2

Part No./Ordering No. RR9KG2400T00NAIMR6B

Rev D

DERATING CURVE

TYPICAL EXTERNAL POWER SUPPLY DERATING CURVE

(FOR EFFICIENCY LEVEL V AND EFFICIENCY LEVEL VI PRODUCTS)

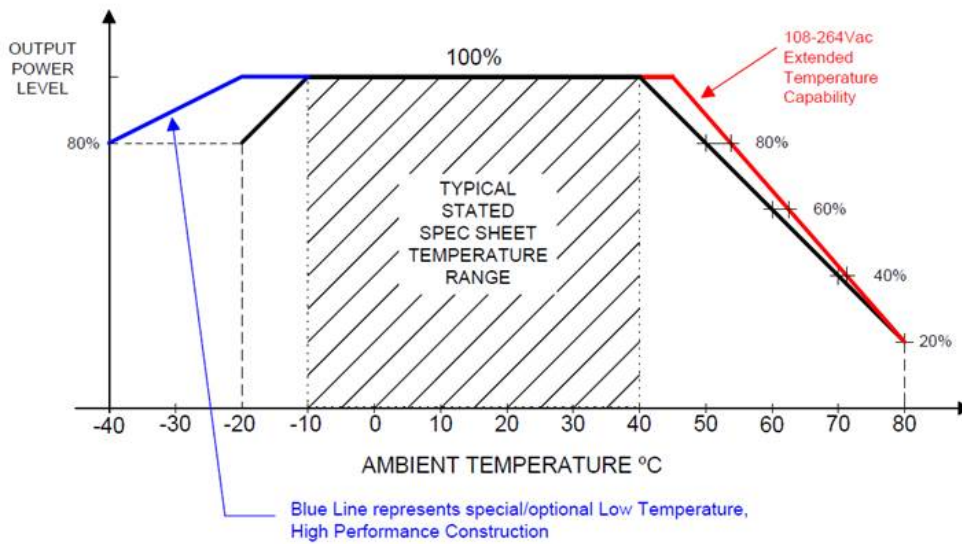

<p>GlobTek, Inc. www.globtek.com 186 Veterans Drive, Northvale, NJ 07647 Tel. (201) 784-1000 Fax (201) 784-0111</p>	<p>Drawing Title: GTM96300-3619.5-4.5-R2, ITE / Medical Power Supply/Class 2/Household Power Supply, Efficiency Level: USA DOE Level VI / Eco-design Directive 2009/125/EC, (EU) 2019/1782, Case Color/Style: GlobTek Black, Wall Plug-in+Desktop Combination, Regulated Switchmode AC-DC Power Supply AC Adaptor, Input Rating: 100-240V~, 50-60 Hz, IEC 60320/C8 w/ Wall Blades Option , Output Rating: 36W, 15.0V@2.4A, Output Configuration: 1200 mm, 16/2 Cond. Round Black, T-plug system (includes 5.5x2.5, 5.5x2.1, 3.5x1.3mm plugs in each kit), Ferrite: None, GlobTek Black, GT Cord # C4257, Pin Out: Polarity Configuration T00 All plugs are Medical Grade, Locking, Polarized once installed, and single use only. Product demonstration link: https://en.globtek.com/news/t00-changeable-output-plug-system-for-power-supplies MOLDED CONNECTORS AVAILABLE, Blades/Input Cord: R-Series 1-15P North America, Approvals: CCC; Korea (12-14.9V Only); ETL; LPS 60950; CAN ICES-3; CB 62368; CB 60950; ETL 1310; ETL; 230V CoC Tier 2; EAC; cETLus 60950-1; UL 1310; cETLus 60601-1-11; NOM (5,7.5,12,15,19,24,48V only); IP40; ETL 62368; Morocco; RCM; RCM; FCC; S-Mark 60950; Double Insulation; LPS 62368; CE; CE; CB 60335; S-Mark IEC/EN 60601-1; CE; China RoHS; Level VI; RoHS; Ukraine; VCCL; WEEE; PSE; PSE; PSE; CB 60601-1;</p>
	<p>Model No. GTM96300-3619.5-4.5-R2</p>
<p>Part No./Ordering No. RR9KG2400T00NAIMR6B</p>	<p>Rev D</p>

INPUT CONFIGURATION

(F1) Class II / Double Insulated



[Alternate grounding configurations](#) available upon request.

IEC 60320/C8 AC Inlet connector

[Blade Insertion Instructions](#)
[R-Blade Style Instruction Video](#)

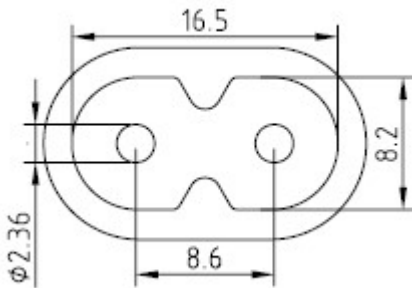

Mates with IEC 60320/C8 Plug

This series of Interchangeable Blade products may be used with Proprietary Interchangeable Blades as described below or with standard international power cords.

Optional INPUT BLADES: R-Socket: below are available blades configurations which are "not included" (unless stated above); may be purchased separately, packaged with power supply, or as a separate "R-KIT" if specified

1. Class II model NEMA 1-15P AC power plug with 2 prongs, R-NA-2(R)
2. Australian AS 3112 configuration: SAA 2 pins Class II, R-SAA-2(R)
3. UK BS 1363 configuration: UK 2 pins (dummy Ground) Class II, R-UK-2(R)
4. European CEE 7/16 configuration: Europlug 2 PINS, Class II, R-EU-2(R)
5. China GB 2099 configuration: 2 blades, Class II; CN P/N:R-CN-2(R)
6. Desktop Insert

Kits

PROPRIETARY INFORMATION

PROPRIETARY OF GLOBTEK, INC. ANY REPRODUCTION, DISCLOSURE OR USE OF THIS DRAWING, IN WHOLE OR IN PART, IS HEREBY PROHIBITED EXCEPT AS SPECIFIED IN

WRITING BY GLOBTEK, INC. © GlobTek, Inc. 2016 - 2020

quest /09/23/2020 12:01:22 AM CLONED FROM GS-1046(R)

<p>GlobTek, Inc. www.globtek.com 186 Veterans Drive, Northvale, NJ 07647 Tel. (201) 784-1000 Fax (201) 784-0111</p>	<p>Drawing Title: GTM96300-3619.5-4.5-R2, ITE / Medical Power Supply/Class 2/Household Power Supply, Efficiency Level: USA DOE Level VI / Eco-design Directive 2009/125/EC, (EU) 2019/1782, Case Color/Style: GlobTek Black, Wall Plug-in+Desktop Combination, Regulated Switchmode AC-DC Power Supply AC Adaptor, Input Rating: 100-240V~, 50-60 Hz, IEC 60320/C8 w/ Wall Blades Option , Output Rating: 36W, 15.0V@2.4A, Output Configuration: 1200 mm, 16/2 Cond. Round Black, T-plug system (includes 5.5x2.5, 5.5x2.1, 3.5x1.3mm plugs in each kit), Ferrite: None, GlobTek Black, GT Cord # C4257, Pin Out: Polarity Configuration T00 All plugs are Medical Grade, Locking, Polarized once installed, and single use only. Product demonstration link: https://en.globtek.com/news/t00-changeable-output-plug-system-for-power-supplies MOLDED CONNECTORS AVAILABLE, Blades/Input Cord: R-Series 1-15P North America, Approvals: CCC; Korea (12-14.9V Only); ETL; LPS 60950; CAN ICES-3; CB 62368; CB 60950; ETL 1310; ETL; 230V CoC Tier 2; EAC; cETLus 60950-1; UL 1310; cETLus 60601-1-11; NOM (5,7.5,12,15,19,24,48V only); IP40; ETL 62368; Morocco; RCM; RCM; FCC; S-Mark 60950; Double Insulation; LPS 62368; CE; CB 60335; S-Mark IEC/EN 60601-1; CE; China RoHS; Level VI; RoHS; Ukraine; VCCE; WEEE; PSE; PSE; PSE; CB 60601-1;</p>
	<p>Model No. GTM96300-3619.5-4.5-R2</p>
<p>Part No./Ordering No. RR9KG2400T00NAIMR6B</p>	<p>Rev D</p>

05. R-KIT-2(R): 1,2,3,4 above
06. R-KIT-2-INTL(R): 2,3,4 above

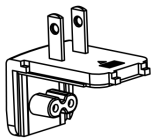

UL 2P

P/N: R-NA-2(R)
NORTH AMERICA
JAPAN

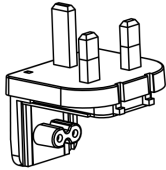

UK 2P

P/N: R-UK-2(R)
UNITED KINGDOM
HONG KONG
SINGAPORE

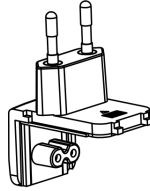

EU 2P

P/N: R-EU-2(R)
EUROPE
SOUTH AMERICA

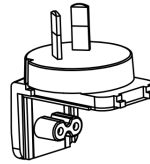

AUS 2P

P/N: R-SAA-2(R)
AUSTRALIA

Standard Cordsets

Below are standard cordsets which are "not included" (unless stated above); these may be purchased separately or packaged with the power supply. Contact your Sales Engineer if the style required is not shown below. Many more available in different lengths, colors or cable material.

[Standard International IEC 320/C7 Cordsets](#)

Part Number	Country	Plug	Connector	Length (mm)	Length (feet)
2094112M703(R)	Argentina (Type I)	IRAM 2063	IEC 320/C7	2000	7
5014112M703A(R)	Australian (Type I)	AS 3112	IEC 320/C7	2000	7
207B4111M8703(R)	Brazil (Type N)	NBR14136	IEC 320/C7	1800	6
4533501M8703(R)	China (Type A)	GB 2099.1	IEC 320/C7	1830	6
2074112M703A(R)	European (Type C)	CEE 7/16	IEC 320/C7	2000	7
2084111M8703(R)	India (Type M)	BS 546	IEC 320/C7	1800	6
451J3401M8703(R)	Japan (Type A)	JIS 8303	IEC 320/C7	1830	6
2044112M703A(R)	Korea (Type C)	KS C8305	IEC 320/C7	2000	7
4511116F703A(R)	N. American (Type A)	NEMA 1-15P	IEC 320/C7	1830	6
4033401M8703A(R)	Taiwan (Type A)	CNS690	IEC 320/C7	1830	6
6104112M703A(R)	UK, Hong Kong, Singapore, Gulf States (Type G)	BS1363	IEC 320/C7	2000	7

PROPRIETARY INFORMATION

GlobTek, Inc. www.globtek.com 186 Veterans Drive, Northvale, NJ 07647 Tel. (201) 784-1000 Fax (201) 784-0111	Drawing Title: GTM96300-3619.5-4.5-R2, ITE / Medical Power Supply/Class 2/Household Power Supply, Efficiency Level: USA DOE Level VI / Eco-design Directive 2009/125/EC, (EU) 2019/1782, Case Color/Style: GlobTek Black, Wall Plug-in+Desktop Combination, Regulated Switchmode AC-DC Power Supply AC Adaptor, Input Rating: 100-240V~, 50-60 Hz, IEC 60320/C8 w/ Wall Blades Option , Output Rating: 36W, 15.0V@2.4A, Output Configuration: 1200 mm, 16/2 Cond. Round Black, T-plug system (includes 5.5x2.5, 5.5x2.1, 3.5x1.3mm plugs in each kit), Ferrite: None, GlobTek Black, GT Cord # C4257, Pin Out: Polarity Configuration T00 All plugs are Medical Grade, Locking, Polarized once installed, and single use only. Product demonstration link: https://en.globtek.com/news/t00-changeable-output-plug-system-for-power-supplies MOLDED CONNECTORS AVAILABLE, Blades/Input Cord: R-Series 1-15P North America, Approvals: CCC; Korea (12-14.9V Only); ETL; LPS 60950; CAN ICES-3; CB 62368; CB 60950; ETL 1310; ETL; 230V CoC Tier 2; EAC; cETLus 60950-1; UL 1310; cETLus 60601-1-11; NOM (5,7.5,12,15,19,24,48V only); IP40; ETL 62368; Morocco; RCM; RCM; FCC; S-Mark 60950; Double Insulation; LPS 62368; CE; CE; CB 60335; S-Mark IEC/EN 60601-1; CE; China RoHS; Level VI; RoHS; Ukraine; VCCI; WEEE; PSE; PSE; PSE; CB 60601-1;
	Model No. GTM96300-3619.5-4.5-R2 Part No./Ordering No. RR9KG2400T00NAIMR6B

OUTPUT CORD AND CONNECTOR: T00/C4257

ACTUAL CONNECTORS, OVERMOLDS, FERRITES MAY VARY SLIGHTLY FROM THE PICTURE BELOW

CABLE TYPE	Round Black
CABLE LENGTH (mm)	1200
CABLE TOLERANCE (mm)	± 50
WIRE GAUGE (AWG)	16
CONDUCTORS	2
HANK DIMENSION (mm)	80 ± 10
CABLE / CONNECTOR OVERMOLD COLOR	GlobTek Black
FERRITE TYPE / DIMENSION	None
FERRITE # OF TURNS (Definition)	N/A
FERRITE DIMENSION FROM STRAIN RELIEF	N/A
FERRITE DIMENSION FROM PLUG	N/A
PLUG TYPE	T-plug system (includes 5.5x2.5, 5.5x2.1, 3.5x1.3mm plugs in each kit)
OUTPUT CONNECTOR GENDER	not applicable
OVERMOLDED	No
OVER MOLD ORIENTATION	Straight
	Polarity Configuration T00 All plugs are Medical Grade, Locking, Polarized once installed, and single use only.
CONNECTOR PIN OUT:	Product demonstration link: https://en.globtek.com/news/t00-changeable-output-plug-system-for-power-supplies MOLDED CONNECTORS AVAILABLE

ADDITIONAL REQUIREMENTS

This novel system allows for rapid shipment of prototype samples or small quantities of common output voltage and current which can fulfill the needs of most common barrel plug specs. The table below explains the standard and non standard options available as part of this system. This system also allows for both Center Positive and Center Negative polarity.

The T00 plug and adapters are Medical Grade, single use only, Polarized after installation, and not removable without use of special tool.

Any of the below options, and more, are available as molded plugs from stock or special order. Please contact GlobTek for more information

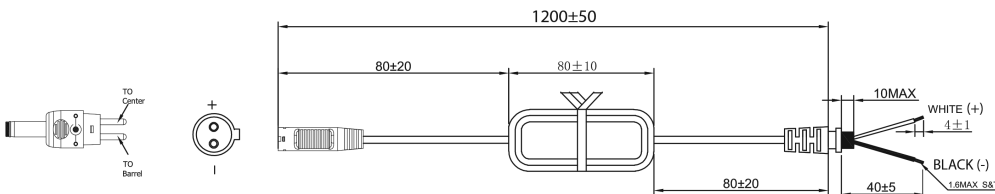

GlobTek, Inc.
 www.globtek.com
 186 Veterans Drive,
 Northvale, NJ 07647
 Tel. (201) 784-1000
 Fax (201) 784-0111

Drawing Title: GTM96300-3619.5-4.5-R2, ITE / Medical Power Supply/Class 2/Household Power Supply, Efficiency Level: USA DOE Level VI / Eco-design Directive 2009/125/EC, (EU) 2019/1782, Case Color/Style: GlobTek Black, Wall Plug-in+Desktop Combination, Regulated Switchmode AC-DC Power Supply AC Adaptor, Input Rating: 100-240V~, 50-60 Hz, IEC 60320/C8 w/ Wall Blades Option , Output Rating: 36W, 15.0V@2.4A, Output Configuration: 1200 mm, 16/2 Cond. Round Black, T-plug system (includes 5.5x2.5, 5.5x2.1, 3.5x1.3mm plugs in each kit), Ferrite: None, GlobTek Black, GT Cord # C4257, Pin Out: Polarity Configuration T00 All plugs are Medical Grade, Locking, Polarized once installed, and single use only. Product demonstration link: <https://en.globtek.com/news/100-changeable-output-plug-system-for-power-supplies> MOLDED CONNECTORS AVAILABLE, Blades/Input Cord: R-Series 1-15P North America, Approvals: CCC; Korea (12-14.9V Only); ETL; LPS 60950; CAN ICES-3; CB 62368; CB 60950; ETL 1310; ETL; 230V CoC Tier 2; EAC; cETLus 60950-1; UL 1310; cETLus 60601-1-11; NOM (5,7.5,12,15,19,24,48V only); IP40; ETL 62368; Morocco; RCM; RCM; FCC; S-Mark 60950; Double Insulation; LPS 62368; CE; CE; CB 60335; S-Mark IEC/EN 60601-1; CE; China RoHS; Level VI; RoHS; Ukraine; VCCE; WEEE; PSE; PSE; PSE; CB 60601-1;

Model No. GTM96300-3619.5-4.5-R2

Part No./Ordering No. RR9KG2400T00NAIMR6B

Rev D

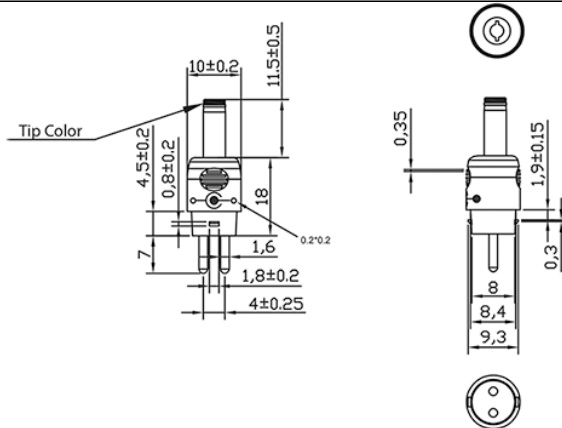

Part #	CROSS REFERENCE	OUTER DIAMETER	INNER DIAMETER	PIN	LENGTH	FORM FACTOR	MALE/FEMALE	INCLUDED IN T00 KIT	TIP COLOR
T-K-11-S(R)	Philmore® 204/2049	3.5	1.3	-	11	STRAIGHT	Female	x	Blue
T-EJ2-95-S(R)	Philmore® 240 plug	4	1.7	-	9.5	STRAIGHT	Female	Order Separately	Brown
T-EJ3-95-S(R)	Philmore® 275 plug	4.75	1.7	-	9.5	STRAIGHT	Female	Order Separately	Red
T-C-95-S(R)	Switchcraft® 722A	5.5	2.1	-	9.5	STRAIGHT	Female	Order Separately	Yellow
T-C-12-S(R)	Switchcraft® 722A	5.5	2.1	-	12	STRAIGHT	Female	x	Yellow
T-L-95-S(R)	Switchcraft® 712A	5.5	2.5	-	9.5	STRAIGHT	Female	Order Separately	Black
T-L-12-S(R)	Switchcraft® 712A	5.5	2.5	-	12	STRAIGHT	Female	x	Black
T-EJ4-95-S(R)	Philmore® 255 plug	5.5	3.3	1	9.5	STRAIGHT	Female	Order Separately	Orange
T-EJ1-95-S(R)	Philmore® 235 plug	2.35	0.7	-	9.5	STRAIGHT	Female	Order Separately	Yellow
	CUI PP3-017/								
T-3.2-0.9-9.0-S(R)	PP-017	3.2	0.9	-	9	STRAIGHT	Female	Order Separately	Black
T-P-S-STER-14(R)	CUI SP-3501	3.5	-	Stereo	14	STRAIGHT	Male	Order Separately	-
T-P-S-MONO-14(R)	CUI MP3-3501	3.5	-	Mono	14	STRAIGHT	Male	Order Separately	-
T-S-S-MONO-11(R)	CUI MP3-2501	2.5	-	Mono	11	STRAIGHT	Male	Order Separately	-
T-S-S-STER-11(R)	CUI SP-25401	2.5	-	Stereo	11	STRAIGHT	Male	Order Separately	-

Option upon request: STRAIGHT Female Barrels are available for special order in any length between 9mm-14mm

This novel system allows for rapid shipment of prototype samples or small quantities of common output voltage and current which can fulfill the needs of most common barrel plug as well as male plug specs. The table explains the standard and non-standard options available as part of this system. This system also allows for both Center Positive and Center Negative

PROPRIETARY INFORMATION

<p>GlobTek, Inc. www.globtek.com 186 Veterans Drive, Northvale, NJ 07647 Tel. (201) 784-1000 Fax (201) 784-0111</p>	<p>Drawing Title: GTM96300-3619.5-4.5-R2, ITE / Medical Power Supply/Class 2/Household Power Supply, Efficiency Level: USA DOE Level VI / Eco-design Directive 2009/125/EC, (EU) 2019/1782, Case Color/Style: GlobTek Black, Wall Plug-in+Desktop Combination, Regulated Switchmode AC-DC Power Supply AC Adaptor, Input Rating: 100-240V~, 50-60 Hz, IEC 60320/C8 w/ Wall Blades Option , Output Rating: 36W, 15.0V@2.4A, Output Configuration: 1200 mm, 16/2 Cond. Round Black, T-plug system (includes 5.5x2.5, 5.5x2.1, 3.5x1.3mm plugs in each kit), Ferrite: None, GlobTek Black, GT Cord # C4257, Pin Out: Polarity Configuration T00 All plugs are Medical Grade, Locking, Polarized once installed, and single use only. Product demonstration link: https://en.globtek.com/news/t00-changeable-output-plug-system-for-power-supplies MOLDED CONNECTORS AVAILABLE, Blades/Input Cord: R-Series 1-15P North America, Approvals: CCC; Korea (12-14.9V Only); ETL; LPS 60950; CAN ICES-3; CB 62368; CB 60950; ETL 1310; ETL; 230V CoC Tier 2; EAC; cETLus 60950-1; UL 1310; cETLus 60601-1-11; NOM (5,7.5,12,15,19,24,48V only); IP40; ETL 62368; Morocco; RCM; RCM; FCC; S-Mark 60950; Double Insulation; LPS 62368; CE; CE; CB 60335; S-Mark IEC/EN 60601-1; CE; China RoHS; Level VI; RoHS; Ukraine; VCCI; WEEE; PSE; PSE; PSE; CB 60601-1;</p>	
	<p>Model No. GTM96300-3619.5-4.5-R2</p>	
	<p>Part No./Ordering No. RR9KG2400T00NAIMR6B</p>	<p>Rev D</p>

polarity.

The T00 plug and adapters are Medical Grade, single use only, Polarized after installation, and not removable without use of special tool.

Any of the below options, and more, are available as molded plugs from stock or special order. Please contact GlobTek for more information

ADDITIONAL OUTPUT PLUG OPTIONS ARE AVAILABLE AT <https://www.globtek.com/connectors/>

STANDARD PLUGS AND CONNECTORS CAN BE SEEN ONLINE AT <https://www.globtek.com/connectors/>

CALCULATE VOLTAGE REGULATION/DROP WITH OUR ONLINE CALCULATOR: <https://en.globtek.com/output-cable-regulation-calculator/>

<p>GlobTek, Inc. www.globtek.com 186 Veterans Drive, Northvale, NJ 07647 Tel. (201) 784-1000 Fax (201) 784-0111</p>	<p>Drawing Title: GTM96300-3619.5-4.5-R2, ITE / Medical Power Supply/Class 2/Household Power Supply, Efficiency Level: USA DOE Level VI / Eco-design Directive 2009/125/EC, (EU) 2019/1782, Case Color/Style: GlobTek Black, Wall Plug-in+Desktop Combination, Regulated Switchmode AC-DC Power Supply AC Adaptor, Input Rating: 100-240V~, 50-60 Hz, IEC 60320/C8 w/ Wall Blades Option , Output Rating: 36W, 15.0V@2.4A, Output Configuration: 1200 mm, 16/2 Cond. Round Black, T-plug system (includes 5.5x2.5, 5.5x2.1, 3.5x1.3mm plugs in each kit), Ferrite: None, GlobTek Black, GT Cord # C4257, Pin Out: Polarity Configuration T00 All plugs are Medical Grade, Locking, Polarized once installed, and single use only. Product demonstration link: https://en.globtek.com/news/t00-changeable-output-plug-system-for-power-supplies MOLDED CONNECTORS AVAILABLE, Blades/Input Cord: R-Series 1-15P North America, Approvals: CCC; Korea (12-14.9V Only); ETL; LPS 60950; CAN ICES-3; CB 62368; CB 60950; ETL 1310; ETL; 230V CoC Tier 2; EAC; cETLus 60950-1; UL 1310; cETLus 60601-1-11; NOM (5,7.5,12,15,19,24,48V only); IP40; ETL 62368; Morocco; RCM; RCM; FCC; S-Mark 60950; Double Insulation; LPS 62368; CE; CE; CB 60335; S-Mark IEC/EN 60601-1; CE; China RoHS; Level VI; RoHS; Ukraine; VCCI; WEEE; PSE; PSE; PSE; CB 60601-1;</p>	
	<p>Model No. GTM96300-3619.5-4.5-R2</p>	
	<p>Part No./Ordering No. RR9KG2400T00NAIMR6B</p>	<p>Rev D</p>

OUTPUT CONNECTOR HOOK UP

TO ADDRESS SYSTEM-LEVEL EMI CONCERNS, FERRITE CHOKES/BEADS MAY BE ADDED/REVISED UPON REQUEST. A SAMPLE KIT OF GLOBTEK'S STANDARD FERRITES IS AVAILABLE UNDER GLOBTEK P/N: EMI-MITIGATION-KIT1

FOR ADDITIONAL INFORMATION, PLEASE READ OUR WHITE PAPER AT:

<https://en.globtek.com/technical-articles/ferrite-kit-radiated-emi-suppression-kit-for-globtek-power-supplies-cable-assemblies>

GlobTek, Inc. www.globtek.com 186 Veterans Drive, Northvale, NJ 07647 Tel. (201) 784-1000 Fax (201) 784-0111	Drawing Title: GTM96300-3619.5-4.5-R2, ITE / Medical Power Supply/Class 2/Household Power Supply, Efficiency Level: USA DOE Level VI / Eco-design Directive 2009/125/EC, (EU) 2019/1782, Case Color/Style: GlobTek Black, Wall Plug-in+Desktop Combination, Regulated Switchmode AC-DC Power Supply AC Adaptor, Input Rating: 100-240V~, 50-60 Hz, IEC 60320/C8 w/ Wall Blades Option , Output Rating: 36W, 15.0V@2.4A, Output Configuration: 1200 mm, 16/2 Cond. Round Black, T-plug system (includes 5.5x2.5, 5.5x2.1, 3.5x1.3mm plugs in each kit), Ferrite: None, GlobTek Black, GT Cord # C4257, Pin Out: Polarity Configuration T00 All plugs are Medical Grade, Locking, Polarized once installed, and single use only. Product demonstration link: https://en.globtek.com/news/t00-changeable-output-plug-system-for-power-supplies MOLDED CONNECTORS AVAILABLE, Blades/Input Cord: R-Series 1-15P North America, Approvals: CCC; Korea (12-14.9V Only); ETL; LPS 60950; CAN ICES-3; CB 62368; CB 60950; ETL 1310; ETL; 230V CoC Tier 2; EAC; cETLus 60950-1; UL 1310; cETLus 60601-1-11; NOM (5,7.5,12,15,19,24,48V only); IP40; ETL 62368; Morocco; RCM; RCM; FCC; S-Mark 60950; Double Insulation; LPS 62368; CE; CE; CB 60335; S-Mark IEC/EN 60601-1; CE; China RoHS; Level VI; RoHS; Ukraine; VCCE; WEEE; PSE; PSE; PSE; CB 60601-1;
	Model No. GTM96300-3619.5-4.5-R2 Part No./Ordering No. RR9KG2400T00NAIMR6B

LABEL:L-1186

LABEL P/N:	Standard GT
MATERIAL:	Flat Thermal Transfer, Imprintable, Polyester Label and/or Pad Printed and/or Molded, and/or Laser Engraved in the case
BACKGROUND COLOR:	Black if housing is Black, White or Silver if housing is White or Gray.
TEXT COLOR:	White or Silver if label is Black Background for Black housing. Black if label is White or Silver background and Housing is White or Gray.
LABEL WIDTH (mm):	37.5
LABEL HEIGHT (mm):	33.5
SPECIAL BARCODE LABEL MATERIAL:	

Below is the minimum information which will appear on the label. NOTE: in the logo area additional/actual positioning of symbols and text is subjected to change as per agency updates/requirements or additional model approvals become available. Regulatory certifications/label markings may be in logo area on the label or molded into the case housing outside the label area. Information will be shown via label and/or pad printed and/or molded and/or laser engraved in the case. * Date code markings at GlobTek option

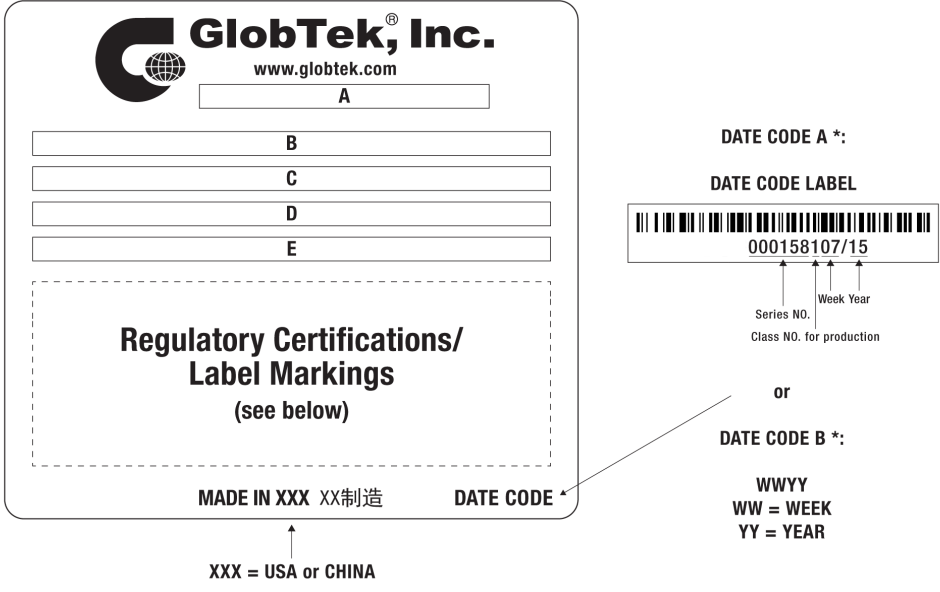

- A=ITE / Medical Power Supply/Class 2/Household Power Supply
- B=P/N: (料号) RR9KG2400T00NAIMR6B
- C=Model (型号) GTM96300-3619.5-4.5-R2
- D=Input (输入)100-240V~, 50-60 Hz, 1A
- E=Output (输出)15.0 V --- 2.4 A, 36.0W

<p>GlobTek, Inc. www.globtek.com 186 Veterans Drive, Northvale, NJ 07647 Tel. (201) 784-1000 Fax (201) 784-0111</p>	<p>Drawing Title: GTM96300-3619.5-4.5-R2, ITE / Medical Power Supply/Class 2/Household Power Supply, Efficiency Level: USA DOE Level VI / Eco-design Directive 2009/125/EC, (EU) 2019/1782, Case Color/Style: GlobTek Black, Wall Plug-in+Desktop Combination, Regulated Switchmode AC-DC Power Supply AC Adaptor, Input Rating: 100-240V~, 50-60 Hz, IEC 60320/C8 w/ Wall Blades Option , Output Rating: 36W, 15.0V@2.4A, Output Configuration: 1200 mm, 16/2 Cond. Round Black, T-plug system (includes 5.5x2.5, 5.5x2.1, 3.5x1.3mm plugs in each kit), Ferrite: None, GlobTek Black, GT Cord # C4257, Pin Out: Polarity Configuration T00 All plugs are Medical Grade, Locking, Polarized once installed, and single use only. Product demonstration link: https://en.globtek.com/news/t00-changeable-output-plug-system-for-power-supplies MOLDED CONNECTORS AVAILABLE, Blades/Input Cord: R-Series 1-15P North America, Approvals: CCC; Korea (12-14.9V Only); ETL; LPS 60950; CAN ICES-3; CB 62368; CB 60950; ETL 1310; ETL; 230V CoC Tier 2; EAC; cETLus 60950-1; UL 1310; cETLus 60601-1-11; NOM (5,7.5,12,15,19,24,48V only); IP40; ETL 62368; Morocco; RCM; RCM; FCC; S-Mark 60950; Double Insulation; LPS 62368; CE; CE; CB 60335; S-Mark IEC/EN 60601-1; CE; China RoHS; Level VI; RoHS; Ukraine; VCCI; WEEE; PSE; PSE; PSE; CB 60601-1;</p> <p>Model No. GTM96300-3619.5-4.5-R2</p>	<p>Part No./Ordering No. RR9KG2400T00NAIMR6B</p> <p>Rev D</p>
---	---	---

AGENCY ONLINE DOCUMENTS	http://www.globtek.info/certs/GTM96300-TZ/
CE EC-Declaration for Medical	http://globtek.force.com/models/ec_declaration_product?id=01ta0000007bruB&m=1
CE EC-Declaration for Industrial/Commercial/ITE	http://globtek.force.com/models/ec_declaration_product?id=01ta0000007bruB&i=2
CE EC-Declaration for Household	http://globtek.force.com/models/ec_declaration_product?id=01ta0000007bruB&h=3
UKCA-Declaration for Medical	
UKCA-Declaration for Industrial/Commercial/ITE	
UKCA-Declaration for Household	
Morocco SDoC Declaration	https://globtek.secure.force.com/models/Morocco_SDoC_Declaration?id=a00a000000MmVxmEAF
RoHS/RoHS3 Declaration	https://www.globtek.com/pdf/rohs_cert/01ta0000007bruBAAQ
REACH Declaration	https://www.globtek.com/pdf/iso_certificates/REACH.pdf
Conflict Minerals Declaration	https://www.globtek.com/pdf/conflict-minerals.pdf
IPXY rating is based on 3rd party testing and customers should check suitability and test system level IPXY rating before ordering.	

Regulatory Certifications/Label Markings

LATEST PRODUCT/MODEL CERTIFICATIONS: <http://en.globtek.com/datasheet/id/a00a000000MmVxm>

AGENCY ONLINE DOCUMENTS: <http://www.globtek.info/certs/GTM96300-TZ/>



(F1) Class II / Double Insulated



Polarity Configuration T00 All plugs are Medical Grade, Locking, Polarized once installed, and single use only.
Product demonstration link: <https://en.globtek.com/news/t00-changeable-output-plug-system-for-power-supplies>
MOLDED CONNECTORS AVAILABLE

GlobTek, Inc. www.globtek.com 186 Veterans Drive, Northvale, NJ 07647 Tel. (201) 784-1000 Fax (201) 784-0111	Drawing Title: GTM96300-3619.5-4.5-R2, ITE / Medical Power Supply/Class 2/Household Power Supply, Efficiency Level: USA DOE Level VI / Eco-design Directive 2009/125/EC, (EU) 2019/1782, Case Color/Style: GlobTek Black, Wall Plug-in+Desktop Combination, Regulated Switchmode AC-DC Power Supply AC Adaptor, Input Rating: 100-240V~, 50-60 Hz, IEC 60320/C8 w/ Wall Blades Option , Output Rating: 36W, 15.0V@2.4A, Output Configuration: 1200 mm, 16/2 Cond. Round Black, T-plug system (includes 5.5x2.5, 5.5x2.1, 3.5x1.3mm plugs in each kit), Ferrite: None, GlobTek Black, GT Cord # C4257, Pin Out: Polarity Configuration T00 All plugs are Medical Grade, Locking, Polarized once installed, and single use only. Product demonstration link: https://en.globtek.com/news/100-changeable-output-plug-system-for-power-supplies MOLDED CONNECTORS AVAILABLE, Blades/Input Cord: R-Series 1-15P North America, Approvals: CCC; Korea (12-14.9V Only); ETL; LPS 60950; CAN ICES-3; CB 62368; CB 60950; ETL 1310; ETL; 230V CoC Tier 2; EAC; cETLus 60950-1; UL 1310; cETLus 60601-1-11; NOM (5,7.5,12,15,19,24,48V only); IP40; ETL 62368; Morocco; RCM; RCM; FCC; S-Mark 60950; Double Insulation; LPS 62368; CE; CE; CB 60335; S-Mark IEC/EN 60601-1; CE; China RoHS; Level VI; RoHS; Ukraine; VCCI; WEEE; PSE; PSE; PSE; CB 60601-1;	
	Model No. GTM96300-3619.5-4.5-R2	
	Part No./Ordering No. RR9KG2400T00NAIMR6B	Rev D

PACKAGING

Packing Spec P/N:

Box Qty:	60
Gift Box Size (mm):	142*62*60
Gift Box Color:	White
Master Carton Size (mm):	442 x 330 x 275
Master Carton Cubic Volume (m³):	0.04
Master GW (Kg):	15.2 kg
BLADES INCLUDED:	:
BLADE/CORD INSTALLED:	:
USER MANUAL*:	
USER MANUAL WEB LINK:	

* This specification sheet is considered the user manual for all applications. It is expected that the buyer of this product will use it to formulate their own user manual for their end product and a user manual specifically for the power adapter is not usually required. If a user manual is not specifically listed above then none will be provided with this unit.

<p>GlobTek, Inc. www.globtek.com 186 Veterans Drive, Northvale, NJ 07647 Tel. (201) 784-1000 Fax (201) 784-0111</p>	<p>Drawing Title: GTM96300-3619.5-4.5-R2, ITE / Medical Power Supply/Class 2/Household Power Supply, Efficiency Level: USA DOE Level VI / Eco-design Directive 2009/125/EC, (EU) 2019/1782, Case Color/Style: GlobTek Black, Wall Plug-in+Desktop Combination, Regulated Switchmode AC-DC Power Supply AC Adaptor, Input Rating: 100-240V~, 50-60 Hz, IEC 60320/C8 w/ Wall Blades Option , Output Rating: 36W, 15.0V@2.4A, Output Configuration: 1200 mm, 16/2 Cond. Round Black, T-plug system (includes 5.5x2.5, 5.5x2.1, 3.5x1.3mm plugs in each kit), Ferrite: None, GlobTek Black, GT Cord # C4257, Pin Out: Polarity Configuration T00 All plugs are Medical Grade, Locking, Polarized once installed, and single use only. Product demonstration link: https://en.globtek.com/news/100-changeable-output-plug-system-for-power-supplies MOLDED CONNECTORS AVAILABLE, Blades/Input Cord: R-Series 1-15P North America, Approvals: CCC; Korea (12-14.9V Only); ETL; LPS 60950; CAN ICES-3; CB 62368; CB 60950; ETL 1310; ETL; 230V CoC Tier 2; EAC; cETLus 60950-1; UL 1310; cETLus 60601-1-11; NOM (5,7.5,12,15,19,24,48V only); IP40; ETL 62368; Morocco; RCM; RCM; FCC; S-Mark 60950; Double Insulation; LPS 62368; CE; CE; CB 60335; S-Mark IEC/EN 60601-1; CE; China RoHS; Level VI; RoHS; Ukraine; VCCI; WEEE; PSE; PSE; PSE; CB 60601-1;</p>	
	<p>Model No. GTM96300-3619.5-4.5-R2</p>	
	<p>Part No./Ordering No. RR9KG2400T00NAIMR6B</p>	<p>Rev D</p>

INSTRUCTIONS TO THE OEM SYSTEMS ENGINEER

It is the responsibility of the OEM systems engineer to provide the end system user instructions and warnings for the use of this product in the end system.

If an input cord is required for this product, AC Mains voltage should be provided to the power supply by a power supply cord approved to the national standards of the country in which it will be used.

This power supply is not designed to be repaired. No serviceable parts inside. A blown internal fuse is an indication of catastrophic failure of circuit component(s). If a Failure Analysis is required for a failed power supply/battery charger, please return the damaged unit to Globtek for an accurate determination of the root cause of the failure.

EMC Compliance of the complete OEM product, including the GlobTek power supply/battery charger needs to be verified by the OEM systems engineer.

INSTRUCTION SHEET

N/A