

GloTek, Inc. www.globtek.com 186 Veterans Drive, Northvale, NJ 07647 Tel. (201) 784-1000 Fax (201) 784-0111	Drawing Title: GTM96600-6012-T3, ITE / Medical Power Supply/Class 2/Household Power Supply, Efficiency Level: VI, Case Color/Style: GlobTek Black, Desktop/External, Regulated Switchmode AC-DC Power Supply AC Adaptor, Input Rating: 100-240V~, 50-60Hz, IEC 60320/C14 , Output Rating: 60W, 12V@5A, Output Configuration: 1200 mm, 16/1C + Shield Cond, UL 1185, Female Barrel 5.5*2.1*11mm WITH internal Spring Clip and Locking Notch or Equal, Ferrite: Core Size: 14.2*28.5*8.2, GlobTek Black, GT Cord # C4032, Pin Out: Center Positive (+V), Blades/Input Cord: Not Applicable, Approvals: LPS; India; IP41; CB 60335; Fuse 60335; 230V CoC Tier 2; ETL; EAC; South Africa; UL 1310; cETLus; cETLus; CB 62368; S-Mark 60950; IRAM; Ukraine; CB 60950; Class I; ETL; NOM; CCC; RCM; CB 60601-1; S-Mark IEC/EN 60601-1; ETL; cULus; Taiwan BSMI; Korea (6.3VOnly); PSE; PSE; PSE; WEEE; VCCI; CE; Level VI; China RoHS; RoHS; FCC;	
	Model No. GTM96600-6012-T3	
	Part No./Ordering No. TR9CE5000CCPCIMR6B	Rev B

## REVISION HISTORY

REV	DESCRIPTION	SUB	DATE	APPROVED
B	Update RoHS 2 to RoHS,Ukraine UKRSepr, earth. Add BIS,BOOK,BSMI,CCC,EAC,ETL(60601),ETL1310,LPS,RCM.	QA	10/11/2018	QA
A	Initial release.	Iren	12/23/2016	QA

In Addition to GlobTek Inc.'s renewed ISO9001:2015 - Quality Management System Certification, GlobTek Inc. is now certified to:

ISO13485:2016 - Medical Devices Quality Management System Certification  
ISO14001:2015 - Environmental Management System Certification

ISO Certificates are available online at <https://www.globtek.com/iso-certificates/>

### Customer Approval of Specification:

Please approve, sign and send back to GlobTek so we can complete order processing.

A delay in receipt of this form will delay delivery schedule.

Company Name:

Customer P/N:

Quote Number:

Date:

Authorized Representative Name:

Authorized Representative Signature:

The acceptance of this specification and use of the product described in this document indicates the acceptance and binding of the customer to Globtek terms and conditions, which supersede all other agreements, terms, and conditions (<https://en.globtek.com/terms-and-conditions/>).

### Footnote:

GlobTek Inc. will not be liable for the safety and performance of these power supplies if unauthorized access and repair occurs. End user should consult applicable UL, CSA or EN standards for proper installation instruction.

### Limitation of Use:

GlobTek products are intended for use with commercial, medical, and/or industrial equipment only. GlobTek product are not authorized for use as mission critical components in life support hazardous environment, nuclear or aircraft applications without prior written approval from the CEO of GlobTek Inc.

Contents of this document are subject to change without prior notice.

GloTek, Inc. www.globtek.com 186 Veterans Drive, Northvale, NJ 07647 Tel. (201) 784-1000 Fax (201) 784-0111	Drawing Title: GTM96600-6012-T3, ITE / Medical Power Supply/Class 2/Household Power Supply, Efficiency Level: VI, Case Color/Style: GlobTek Black, Desktop/External, Regulated Switchmode AC-DC Power Supply AC Adaptor, Input Rating: 100-240V~, 50-60Hz, IEC 60320/C14 , Output Rating: 60W, 12V@5A, Output Configuration: 1200 mm, 16/1C + Shield Cond, UL 1185, Female Barrel 5.5*2.1*11mm WITH internal Spring Clip and Locking Notch or Equal, Ferrite: Core Size: 14.2*28.5*8.2, GlobTek Black, GT Cord # C4032, Pin Out: Center Positive (+V), Blades/Input Cord: Not Applicable, Approvals: LPS; India; IP41; CB 60335; Fuse 60335; 230V CoC Tier 2; ETL; EAC; South Africa; UL 1310; cETLus; cETLus; CB 62368; S-Mark 60950; IRAM; Ukraine; CB 60950; Class I; ETL; NOM; CCC; RCM; CB 60601-1; S-Mark IEC/EN 60601-1; ETL; cULus; Taiwan BSMI; Korea (6.3VOnly); PSE; PSE; PSE; WEEE; VCCI; CE; Level VI; China RoHS; RoHS; FCC;	
	Model No. GTM96600-6012-T3	
	Part No./Ordering No. TR9CE5000CCPCIMR6B	Rev B

## POWER SUPPLY INFORMATION

TYPE:	Desktop/External
TECHNOLOGY:	Regulated Switchmode AC-DC Power Supply AC Adaptor
CASE COLOR:	GlobTek Black
NAMEPLATE RATED INPUT:	100-240V~, 50-60Hz, 1.5A
INPUT CONFIG:	IEC 60320/C14
WATTS:	60.0
VOLTS OUT:	12
CURRENT OUT (Amps):	5
BLADE/CORD INCLUDED:	N/A
BLADE/CORD INSTALLED:	N/A
INGRESS PROTECTION:	IP41
GROUNDING CONFIGURATION:	(E1) Earthed output
EFFICIENCY LEVEL:	VI
OUTPUT CONFIGURATION:	1200 mm, 16/1C + Shield Cond, UL 1185, Female Barrel 5.5*2.1*11mm WITH internal Spring Clip and Locking Notch or Equal, Ferrite: Core Size: 14.2*28.5*8.2, GlobTek Black, GT Cord # C4032
CONNECTOR PIN OUT:	Center Positive (+V)
LABEL SPECS:	Standard GT,L-1186
SPECIAL BARCODE LABEL	
MATERIAL:	No
PACK SPEC:	Standard DT, Cellular packaging, User manual
USER MANUAL:	809-DESKTOPUSERMANUAL

Notes/Modifications/Customizations (notes in this section supersede the values shown in the standard spec):

DIMENSIONS ARE IN MM UNLESS SPECIFIED OTHERWISE.

### PROPRIETARY INFORMATION

PROPRIETARY OF GLOBTEK, INC. ANY REPRODUCTION, DISCLOSURE OR USE OF THIS DRAWING, IN WHOLE OR IN PART, IS HEREBY PROHIBITED EXCEPT AS SPECIFIED IN

WRITING BY GLOBTEK, INC. © GlobTek, Inc. 2016 - 2019

quest /05/20/2019 2:38:49 PM CLONED FROM TR9CE5000YL3CIMR6B

GlobTek, Inc. www.globtek.com 186 Veterans Drive, Northvale, NJ 07647 Tel. (201) 784-1000 Fax (201) 784-0111	Drawing Title: GTM96600-6012-T3, ITE / Medical Power Supply/Class 2/Household Power Supply, Efficiency Level: VI, Case Color/Style: GlobTek Black, Desktop/External, Regulated Switchmode AC-DC Power Supply AC Adaptor, Input Rating: 100-240V~, 50-60Hz, IEC 60320/C14, Output Rating: 60W, 12V@5A, Output Configuration: 1200 mm, 16/1C + Shield Cond, UL 1185, Female Barrel 5.5*2.1*11mm WITH internal Spring Clip and Locking Notch or Equal, Ferrite: Core Size: 14.2*28.5*8.2, GlobTek Black, GT Cord # C4032, Pin Out: Center Positive (+V), Blades/Input Cord: Not Applicable, Approvals: LPS; India; IP41; CB 60335; Fuse 60335; 230V CoC Tier 2; ETL; EAC; South Africa; UL 1310; cETLus; cETLus; CB 62368; S-Mark 60950; IRAM; Ukraine; CB 60950; Class I; ETL; NOM; CCC; RCM; CB 60601-1; S-Mark IEC/EN 60601-1; ETL; cULus; Taiwan BSMI; Korea (6.3VOnly); PSE; PSE; PSE; WEEE; VCCI; CE; Level VI; China RoHS; RoHS; FCC;	
	Model No. GTM96600-6012-T3	
	Part No./Ordering No. TR9CE5000CCPCIMR6B	Rev B

## ELECTRICAL SPECIFICATIONS

### A) ELECTRICAL SPECIFICATIONS:

01. Input Voltage: Specified 90-264 Vac, Nameplate rated: 100-240Vac
  - 90-264 Vac range @ 100% of rated load current
  - 85-264 Vac range @ 85% of rated load current
  - 110-370 VDC range @ 100% of rated load current
02. Input Frequency: Specified 47-63 Hz, Nameplate rated 50-60Hz
03. Output Regulation: +/- 5% measured at the output connector
04. Line Voltage Regulation: +/- 0.5% typical measured at full load
05. Green Power On Indicator LED
06. Output Ripple (Vp-p): 1% or 100 mV whichever is greater, measured at 20 MHz bandwidth with 0.1 uf ceramic capacitor in parallel with a low impedance 47 uf electrolytic capacitor connected at the end of the output connector
07. Turn-ON/OFF Overshoot: 5% maximum, 1 mS typical recovery time for 40% to 70% step load
08. Turn-ON Delay: 1 second maximum @ full load, nominal line
09. Hold-Up Time: 8 mS typical @ nominal input voltage and full load
10. Inrush Current: 30A/60A maximum cold start @ 115/230Vac input
11. Efficiency: Compliant with Efficiency Level VI and CoC Tier 2 standards
12. No Load Standby Power: <0.075 W @ 230Vac for <= 49W output power rating,  
<0.15W @ 230Vac for > 49W output power rating

### B) PROTECTION

01. Input Protection: Input line fusing and 300Vac MOV
02. Short Circuit/ Overload: Electronically Protected unit will auto recover upon removal of fault
  - Output Current Limit: 110% to 160% of rated output current
  - (upper end of current limit range is determined by normal output power rating, not derated output power level)
03. Output Over-Voltage: 110% to 130% of nominal output voltage

### C) SAFETY

01. Dielectric Withstand Voltage: 4000Vac or 5656Vdc from input to output, On Class I models, 3000Vac or 4242Vdc from input to earth
02. Earth Leakage Current: Class I models < 300uA, N/A for Class II models
03. Touch Current: Class I models < 20uA, Class II models < 85uA, F2 Models < 20uA
04. [Output Isolation Options](#):
  - a) C8 or C18 Inlet, Class II
  - b) C6 or C14 Inlet, Class II FE, Output Isolated from Earth contact
  - c) C6 or C14 Inlet, Class I, Output negative directly attached to Earth contact
05. Earth Continuity Test: < 0.1 Ohm between Earth Pin at AC input and PCB termination point (Class I models only)
06. Means of Protection: 2 x MOPP
07. Compliant Standards: See listings at end of this drawing for specifics

### D) EMC

- EN 60601-1-2, 4<sup>th</sup> edition
- Emissions, per EN 55032, EN 61000-6-3, EN 61000-6-4, CISPR11 and CISPR22
- Conducted Emissions: Class B, FCC Part 15, Class B
  - Radiated Emissions: Class B, FCC Part 15, Class B
  - Line Frequency Harmonics EN61000-3-2, Class A

#### PROPRIETARY INFORMATION

PROPRIETARY OF GLOBTEK, INC. ANY REPRODUCTION, DISCLOSURE OR USE OF THIS DRAWING, IN WHOLE OR IN PART, IS HEREBY PROHIBITED EXCEPT AS SPECIFIED IN

WRITING BY GLOBTEK, INC. © GlobTek, Inc. 2016 - 2019

quest /05/20/2019 2:38:49 PM CLONED FROM TR9CE5000YL3CIMR6B

GloBtek, Inc. www.globtek.com 186 Veterans Drive, Northvale, NJ 07647 Tel. (201) 784-1000 Fax (201) 784-0111	Drawing Title: GTM96600-6012-T3, ITE / Medical Power Supply/Class 2/Household Power Supply, Efficiency Level: VI, Case Color/Style: GloBtek Black, Desktop/External, Regulated Switchmode AC-DC Power Supply AC Adaptor, Input Rating: 100-240V~, 50-60Hz, IEC 60320/C14 , Output Rating: 60W, 12V@5A, Output Configuration: 1200 mm, 16/1C + Shield Cond, UL 1185, Female Barrel 5.5*2.1*11mm WITH internal Spring Clip and Locking Notch or Equal, Ferrite: Core Size: 14.2*28.5*8.2, GloBtek Black, GT Cord # C4032, Pin Out: Center Positive (+V), Blades/Input Cord: Not Applicable, Approvals: LPS; India; IP41; CB 60335; Fuse 60335; 230V CoC Tier 2; ETL; EAC; South Africa; UL 1310; cETLus; cETLus; CB 62368; S-Mark 60950; IRAM; Ukraine; CB 60950; Class I; ETL; NOM; CCC; RCM; CB 60601-1; S-Mark IEC/EN 60601-1; ETL; cULus; Taiwan BSMI; Korea (6.3VOnly); PSE; PSE; PSE; WEEE; VCCI; CE; Level VI; China RoHS; RoHS; FCC;	
	Model No. GTM96600-6012-T3	
	Part No./Ordering No. TR9CE5000CCPCIMR6B	Rev B

#### Voltage Fluctuations/Flicker EN61000-3-3

Immunity, per EN 55024, EN 61000-6-1, EN 61000-6-2

Static Discharge Immunity EN61000-4-2, 10kV Contact Discharge, 20kV air discharge

Radiated RF Immunity EN61000-4-3, 10V/m 80-1000MHz, 3V/m 1-2.7GHz, 80% 1KHz AM.

EFT/Burst Immunity EN61000-4-4, 4kV/100kHz.

Line Surge Immunity EN61000-4-5, 2kV differential, 4kV common-mode

Conducted RF Immunity EN61000-4-6, 3Vrms, 80% 1KHz AM

Power Frequency Magnetic Field Immunity EN61000-4-8, 3A/m

Voltage Dip Immunity EN61000-4-11, Criteria

#### E) OTHER:

01. MTBF: 1,000,000 Hours @ 40°C ambient temperature, Full Load

02. GTM96600 Family: -20°C to 40°C ambient temperature with full load

Regarding Operating Temperature,

a- See below derating table for output power capability at alternate temperature

b- Extended low end temperature range available as custom option

03. Operating Humidity: 0% to 95% relative humidity, non-condensing

04. Storage Temperature: -30°C to 80°C

05. Operating Altitude: 5000 Meters

06. ROHS: Compliant with latest regulations, see approvals section below

#### F) ENCLOSURE

01. Housing: High impact plastic, 94V0 polycarbonate, non-vented

02. Markings: Label or Laser Printed

03. AC Input mechanical options: Desktop C6, C8, C14 or C18 IEC Inlet.

Hybrid option (Desktop or Changeable Blade Wall Plug-in) Class I or Class II input

#### G) SPECIAL OPTIONS

01. Cost reduction, removal of LED

02. Custom Cordsets, various cordage types, and connector types

03. Custom Markings

04. Short term Output Surge Capability for motor loads, and other high peak current loads. Available to 120W for 1 second, and higher levels possible for limited input voltage range, or allowed voltage dip.

05. Reduced Leakage Current versions

06. Tightened output voltage tolerance

07. Reduced output ripple level

08. Reduced output power rating marking

09. High Rel PCB laminate with Plated through Holes for IPC610 Class 2 Compliance

10. Low Temperature operation, down to -40°C

11. Special Housing Colors and Cordset Colors

12. Back EMF applications, custom solutions. For unusual motor load aps and other high inductance reverse energy flow requirements

13. Improved Ingress Protection Rating

#### H) OUTPUT CONNECTORS

Several output connector options are available with various output current ratings.

GloBtek can supply 10A rated 2.1mm and 2.5mm style DC Power Jacks, to complement our

10A output rated 2.1mm and 2.5mm DC power plugs used on our output cordsets.

Please visit <https://en.globtek.com/news/high-current-coaxial-barrel-plug-jacks-for-high-wattage-power-supplies> for a real time product offering of

#### PROPRIETARY INFORMATION

PROPRIETARY OF GLOBTEK, INC. ANY REPRODUCTION, DISCLOSURE OR USE OF THIS DRAWING, IN WHOLE OR IN PART, IS HEREBY PROHIBITED EXCEPT AS SPECIFIED IN

WRITING BY GLOBTEK, INC. © GloBtek, Inc. 2016 - 2019

quest /05/20/2019 2:38:49 PM CLONED FROM TR9CE5000YL3CIMR6B

<p>GlobTek, Inc. www.globtek.com 186 Veterans Drive, Northvale, NJ 07647 Tel. (201) 784-1000 Fax (201) 784-0111</p>	<p>Drawing Title: GTM96600-6012-T3, ITE / Medical Power Supply/Class 2/Household Power Supply, Efficiency Level: VI, Case Color/Style: GlobTek Black, Desktop/External, Regulated Switchmode AC-DC Power Supply AC Adaptor, Input Rating: 100-240V~, 50-60Hz, IEC 60320/C14, Output Rating: 60W, 12V@5A, Output Configuration: 1200 mm, 16/1C + Shield Cond, UL 1185, Female Barrel 5.5*2.1*11mm WITH internal Spring Clip and Locking Notch or Equal, Ferrite: Core Size: 14.2*28.5*8.2, GlobTek Black, GT Cord # C4032, Pin Out: Center Positive (+V), Blades/Input Cord: Not Applicable, Approvals: LPS; India; IP41; CB 60335; Fuse 60335; 230V CoC Tier 2; ETL; EAC; South Africa; UL 1310; cETLus; cETLus; CB 62368; S-Mark 60950; IRAM; Ukraine; CB 60950; Class I; ETL; NOM; CCC; RCM; CB 60601-1; S-Mark IEC/EN 60601-1; ETL; cULus; Taiwan BSMI; Korea (6.3VOnly); PSE; PSE; WEEE; VCCI; CE; Level VI; China RoHS; RoHS; FCC;</p>	
	<p>Model No. GTM96600-6012-T3</p>	
	<p>Part No./Ordering No. TR9CE5000CCPCIMR6B</p>	<p>Rev B</p>

mating connectors.

INGRESS PROTECTION: IP41

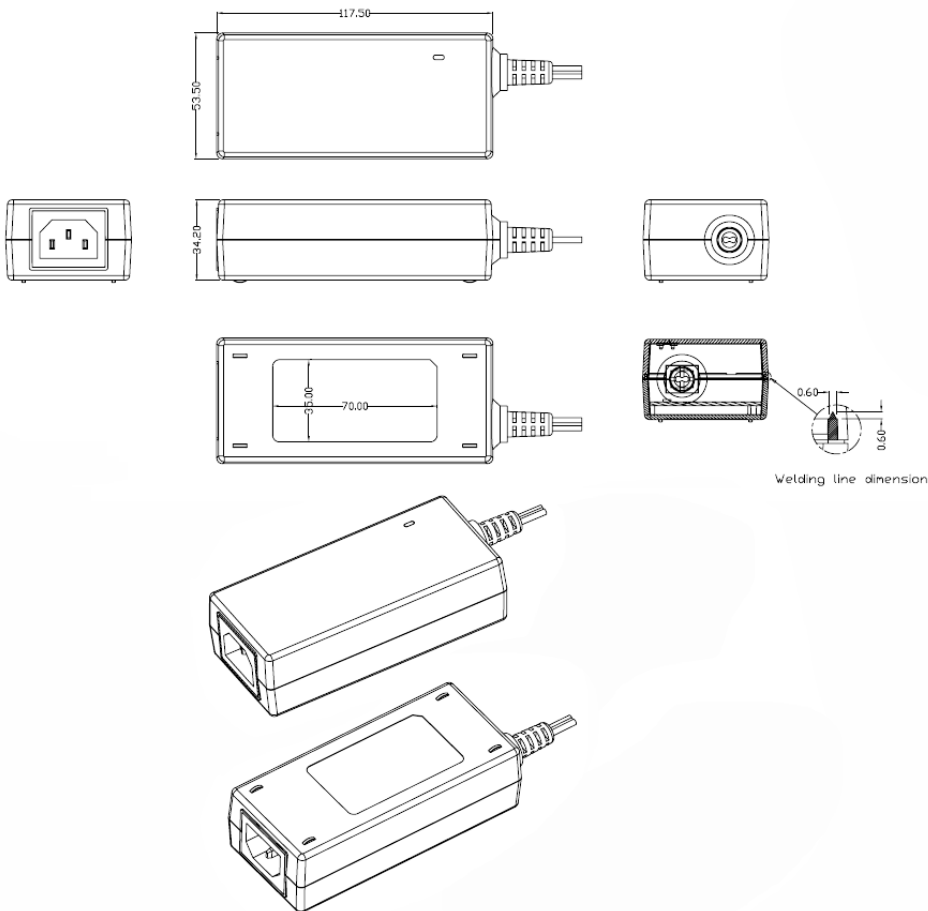

PROPRIETARY INFORMATION

PROPRIETARY OF GLOBTEK, INC. ANY REPRODUCTION, DISCLOSURE OR USE OF THIS DRAWING, IN WHOLE OR IN PART, IS HEREBY PROHIBITED EXCEPT AS SPECIFIED IN WRITING BY GLOBTEK, INC. © GlobTek, Inc. 2016 - 2019

GlobTek, Inc.  
 www.globtek.com  
 186 Veterans Drive,  
 Northvale, NJ 07647  
 Tel. (201) 784-1000  
 Fax (201) 784-0111

Drawing Title: GTM96600-6012-T3, ITE / Medical Power Supply/Class 2/Household Power Supply, Efficiency Level: VI, Case Color/Style: GlobTek Black, Desktop/External, Regulated Switchmode AC-DC Power Supply AC Adaptor, Input Rating: 100-240V~, 50-60Hz, IEC 60320/C14, Output Rating: 60W, 12V@5A, Output Configuration: 1200 mm, 16/1C + Shield Cond, UL 1185, Female Barrel 5.5\*2.1\*11mm WITH internal Spring Clip and Locking Notch or Equal, Ferrite: Core Size: 14.2\*28.5\*8.2, GlobTek Black, GT Cord # C4032, Pin Out: Center Positive (+V), Blades/Input Cord: Not Applicable, Approvals: LPS; India; IP41; CB 60335; Fuse 60335; 230V CoC Tier 2; ETL; EAC; South Africa; UL 1310; cETLus; cETLus; CB 62368; S-Mark 60950; IRAM; Ukraine; CB 60950; Class I; ETL; NOM; CCC; RCM; CB 60601-1; S-Mark IEC/EN 60601-1; ETL; cULus; Taiwan BSMI; Korea (6.3VOnly); PSE; PSE; WEEE; VCCI; CE; Level VI; China RoHS; RoHS; FCC;

Model No. GTM96600-6012-T3

Part No./Ordering No. TR9CE5000CCPCIMR6B

Rev B

DERATING CURVE

TYPICAL EXTERNAL POWER SUPPLY  
 DERATING CURVE

(FOR EFFICIENCY LEVEL V AND EFFICIENCY LEVEL VI PRODUCTS)

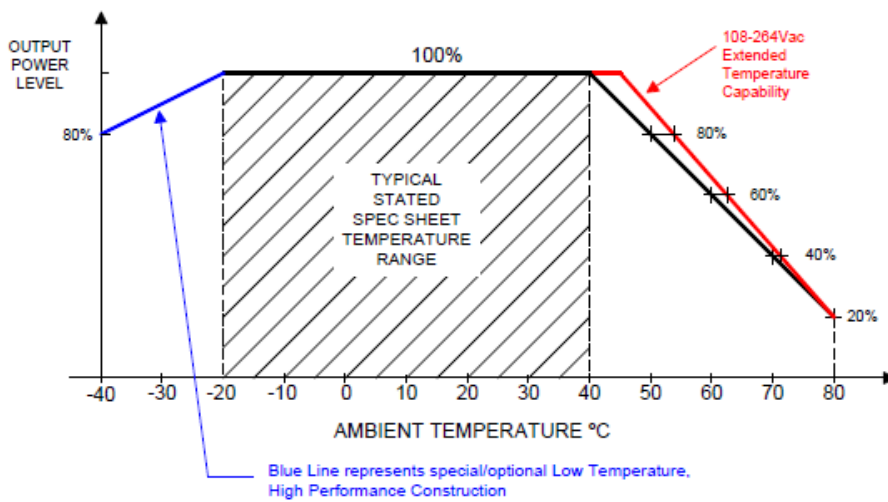

PROPRIETARY INFORMATION

PROPRIETARY OF GLOBTEK, INC. ANY REPRODUCTION, DISCLOSURE OR USE OF THIS DRAWING, IN WHOLE OR IN PART, IS HEREBY PROHIBITED EXCEPT AS SPECIFIED IN

WRITING BY GLOBTEK, INC. © GlobTek, Inc. 2016 - 2019

quest /05/20/2019 2:38:49 PM CLONED FROM TR9CE5000YL3CIMR6B

GloBtek, Inc. www.globtek.com 186 Veterans Drive, Northvale, NJ 07647 Tel. (201) 784-1000 Fax (201) 784-0111	Drawing Title: GTM96600-6012-T3, ITE / Medical Power Supply/Class 2/Household Power Supply, Efficiency Level: VI, Case Color/Style: GlobTek Black, Desktop/External, Regulated Switchmode AC-DC Power Supply AC Adaptor, Input Rating: 100-240V~, 50-60Hz, IEC 60320/C14 , Output Rating: 60W, 12V@5A, Output Configuration: 1200 mm, 16/1C + Shield Cond, UL 1185, Female Barrel 5.5*2.1*11mm WITH internal Spring Clip and Locking Notch or Equal, Ferrite: Core Size: 14.2*28.5*8.2, GlobTek Black, GT Cord # C4032, Pin Out: Center Positive (+V), Blades/Input Cord: Not Applicable, Approvals: LPS; India; IP41; CB 60335; Fuse 60335; 230V CoC Tier 2; ETL; EAC; South Africa; UL 1310; cETLus; cETLus; CB 62368; S-Mark 60950; IRAM; Ukraine; CB 60950; Class I; ETL; NOM; CCC; RCM; CB 60601-1; S-Mark IEC/EN 60601-1; ETL; cULus; Taiwan BSMI; Korea (6.3VOnly); PSE; PSE; PSE; WEEE; VCCI; CE; Level VI; China RoHS; RoHS; FCC;	
	Model No. GTM96600-6012-T3	
	Part No./Ordering No. TR9CE5000CCPCIMR6B	Rev B

## INPUT CONFIGURATION

(E1) Earthed output

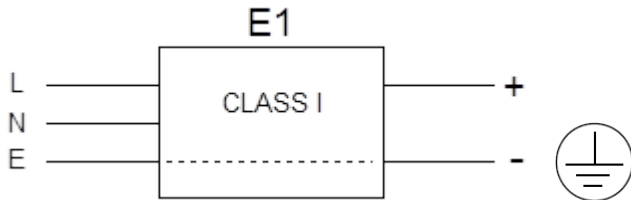

[Alternate grounding configurations](#) available upon request.

Blades/Cord Included:N/A:

Blades/Cord Installed:N/A:

IEC 60320/C14 AC Inlet Connector, Class I, Earth Ground

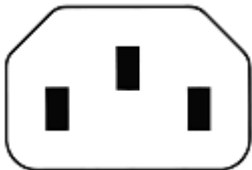

Mates with IEC 60320/C13 Plug

Optional Locking IEC60320 Receptable and cord option available on some models by request.:



## [Standard International IEC 320/C13 Cordsets](#)

Below are standard cordsets which are "not included" (unless stated above); these can be purchased separately or packaged with the power supply. Contact your Sales Engineer if the style required is not shown below. Many more available in different lengths, colors or cable material.

## Stock Power Supply Cords

Part Number/ Link	Country	Plug	Termination	Length (mm)	(Ft)
<a href="#">3021457F701(R)</a>	N. American (Type B)	NEMA 5-15P	IEC 320/C13	2150	7

### PROPRIETARY INFORMATION

PROPRIETARY OF GLOBTEK, INC. ANY REPRODUCTION, DISCLOSURE OR USE OF THIS DRAWING, IN WHOLE OR IN PART, IS HEREBY PROHIBITED EXCEPT AS SPECIFIED IN WRITING BY GLOBTEK, INC. © GlobTek, Inc. 2016 - 2019

GloBtek, Inc. www.globtek.com 186 Veterans Drive, Northvale, NJ 07647 Tel. (201) 784-1000 Fax (201) 784-0111	Drawing Title: GTM96600-6012-T3, ITE / Medical Power Supply/Class 2/Household Power Supply, Efficiency Level: VI, Case Color/Style: GlobTek Black, Desktop/External, Regulated Switchmode AC-DC Power Supply AC Adaptor, Input Rating: 100-240V~, 50-60Hz, IEC 60320/C14 , Output Rating: 60W, 12V@5A, Output Configuration: 1200 mm, 16/1C + Shield Cond, UL 1185, Female Barrel 5.5*2.1*11mm WITH internal Spring Clip and Locking Notch or Equal, Ferrite: Core Size: 14.2*28.5*8.2, GlobTek Black, GT Cord # C4032, Pin Out: Center Positive (+V), Blades/Input Cord: Not Applicable, Approvals: LPS; India; IP41; CB 60335; Fuse 60335; 230V CoC Tier 2; ETL; EAC; South Africa; UL 1310; cETLus; cETLus; CB 62368; S-Mark 60950; IRAM; Ukraine; CB 60950; Class I; ETL; NOM; CCC; RCM; CB 60601-1; S-Mark IEC/EN 60601-1; ETL; cULus; Taiwan BSMI; Korea (6.3VOnly); PSE; PSE; PSE; WEEE; VCCI; CE; Level VI; China RoHS; RoHS; FCC;	
	Model No. GTM96600-6012-T3	
	Part No./Ordering No. TR9CE5000CCPCIMR6B	Rev B

<a href="#">1191068F0701(R)</a>	N. American (Type B)	NEMA 5-15P Hospital	IEC 320/C13	2459	8
<a href="#">2194272M5701-T(R)</a>	Argentina (Type I)	IRAM 2073	IEC 320/C13	2500	8
<a href="#">5502022M5701A(R)</a>	Australian (Type I)	AS3112 / 3 PRONG	IEC 320/C13	2500	8
<a href="#">204B4272M5701(R)</a>	Brazil (Type N)	BRAZIL	IEC 320/C13	2500	8
<a href="#">6023602M5701(R)</a>	China (Type I)	CCC GR2099	IEC 320/C13	2500	8
<a href="#">G8014272M5701(R)</a>	Danish (Type K)	AFSNIT SECTION 107-2-D1	IEC 320/C13	2500	8
<a href="#">23144272M5701-T(R)</a>	Europe (Type E)	CEE 7/7	IEC 320/C13	2500	8
<a href="#">205IN4272M5701(R)</a>	India (Type D)	India IS 1293 (also known as IA16A3 or BS546)	IEC 320/C13	2500	8
<a href="#">208IN4272M5701(R)</a>	India (Type M)	India IS 1293 (also known as IA16A3 or BS546)	IEC320/C13	2500	8
<a href="#">377C4272M5701(R)</a>	Israel (Type H)	ISL 377C	IEC 320/C13	2500	8
<a href="#">23024272M5701(R)</a>	Italy (Type L)	CEI 23-16/VII	IEC 320/C13	2500	8
<a href="#">3003339F701(R)</a> [3x1.25mm2]	Japan (Type B)	JIS 8303 / 3 PINS	IEC 320/C13	2500	8
<a href="#">3003068F2701-HK(R)</a> [3 x 2.0mm2]					
<a href="#">302J115J6F0701J(R)</a>	Japan / North America (Type B – 12A)	JIS 8303 / 3 PINS and NEMA 5-15P (PSE and UL/CUL appr)	IEC 320/C13	1830	6
<a href="#">302J104J6F0701J(R)</a>	Japan / North America (Type B – 15A)	JIS 8303 / 3 PINS and NEMA 5-15P (PSE and UL/CUL appr)	IEC 320/C13	1830	6
<a href="#">2313K3432M5701(R)</a>	Korea (Type F)	KS C 8305	IEC 320/C13	2500	8
<a href="#">5804272M5701(R)</a>	Russia (Type F)	GOST 7396	IEC 320/C13	2500	8
<a href="#">205SA4272M5701(R)</a>	South Africa (Type D)	South Africa SABS164-1 (6A type)	IEC 320/C13	2500	8
<a href="#">2084272M5701(R)</a>	South Africa (Type M)	South Africa SABS164-1 (16A type)	IEC 320/C13	2500	8
<a href="#">23214272M5701(R)</a>	Switzerland (Type J)	SEV 1011	IEC 320/C13	2500	8
<a href="#">3003322M5701(R)</a>	Taiwan (Type B)	BSMI	IEC 320/C13	2500	8
<a href="#">PZ0800100-2M5BK13H(R)</a>	UK, Hong Kong, Singapore, Gulf States (Type G)	BS 1363A	IEC 320/C13	2500	8
<a href="#">7055002M5701A(R)</a>	International	IEC 320 C14-C13	IEC 320/C13	2500	8



GloTek, Inc. www.globtek.com 186 Veterans Drive, Northvale, NJ 07647 Tel. (201) 784-1000 Fax (201) 784-0111	Drawing Title: GTM96600-6012-T3, ITE / Medical Power Supply/Class 2/Household Power Supply, Efficiency Level: VI, Case Color/Style: GlobTek Black, Desktop/External, Regulated Switchmode AC-DC Power Supply AC Adaptor, Input Rating: 100-240V~, 50-60Hz, IEC 60320/C14 , Output Rating: 60W, 12V@5A, Output Configuration: 1200 mm, 16/1C + Shield Cond, UL 1185, Female Barrel 5.5*2.1*11mm WITH internal Spring Clip and Locking Notch or Equal, Ferrite: Core Size: 14.2*28.5*8.2, GlobTek Black, GT Cord # C4032, Pin Out: Center Positive (+V), Blades/Input Cord: Not Applicable, Approvals: LPS; India; IP41; CB 60335; Fuse 60335; 230V CoC Tier 2; ETL; EAC; South Africa; UL 1310; cETLus; cETLus; CB 62368; S-Mark 60950; IRAM; Ukraine; CB 60950; Class I; ETL; NOM; CCC; RCM; CB 60601-1; S-Mark IEC/EN 60601-1; ETL; cULus; Taiwan BSMI; Korea (6.3VOnly); PSE; PSE; PSE; WEEE; VCCI; CE; Level VI; China RoHS; RoHS; FCC;	
	Model No. GTM96600-6012-T3	
	Part No./Ordering No. TR9CE5000CCPCIMR6B	Rev B

**OUTPUTCORD AND CONNECTOR: C1S/C4032**

ACTUAL CONNECTORS, OVERMOLDS, FERRITES MAY VARY SLIGHTLY FROM THE PICTURE BELOW

CABLE TYPE	UL 1185
CABLE LENGTH&#160;(mm)	1200
CABLE TOLERANCE&#160;(mm)	+100-0
WIRE GAUGE (AWG)	16
CONDUCTORS	1C + Shield
HANK DIMENSION (mm)	80 ± 10
CABLE / CONNECTOR OVERMOLD COLOR	GlobTek Black
FERRITE TYPE / DIMENSION	Core Size: 14.2*28.5*8.2
FERRITE # OF TURNS( <a href="#">Definition</a> )	2 Pass thru core (1 turns)
FERRITE DIMENSION FROM STRAIN RELIEF	50 ±10
FERRITE DIMENSION FROM PLUG	N/A
PLUG TYPE	Female Barrel 5.5*2.1*11mm WITH internal Spring Clip and Locking Notch or Equal
OUTPUT CONNECTOR SEX	
OVERMOLDED	
OVER MOLD ORIENTATION	Straight
CONNECTOR PIN OUT:	Center Positive (+V)
ADDITIONAL REQUIREMENTS	

ADDITIONAL OUTPUT PLUG OPTIONS ARE AVAILABLE AT <https://www.globtek.com/connectors/>  
STANDARD PLUGS AND CONNECTORS CAN BE SEEN ONLINE AT <https://www.globtek.com/connectors/>

GloTek, Inc. www.globtek.com 186 Veterans Drive, Northvale, NJ 07647 Tel. (201) 784-1000 Fax (201) 784-0111	Drawing Title: GTM96600-6012-T3, ITE / Medical Power Supply/Class 2/Household Power Supply, Efficiency Level: VI, Case Color/Style: GlobTek Black, Desktop/External, Regulated Switchmode AC-DC Power Supply AC Adaptor, Input Rating: 100-240V~, 50-60Hz, IEC 60320/C14, Output Rating: 60W, 12V@5A, Output Configuration: 1200 mm, 16/1C + Shield Cond, UL 1185, Female Barrel 5.5*2.1*11mm WITH internal Spring Clip and Locking Notch or Equal, Ferrite: Core Size: 14.2*28.5*8.2, GlobTek Black, GT Cord # C4032, Pin Out: Center Positive (+V), Blades/Input Cord: Not Applicable, Approvals: LPS; India; IP41; CB 60335; Fuse 60335; 230V CoC Tier 2; ETL; EAC; South Africa; UL 1310; cETLus; cETLus; CB 62368; S-Mark 60950; IRAM; Ukraine; CB 60950; Class I; ETL; NOM; CCC; RCM; CB 60601-1; S-Mark IEC/EN 60601-1; ETL; cULus; Taiwan BSMI; Korea (6.3VOnly); PSE; PSE; PSE; WEEE; VCCI; CE; Level VI; China RoHS; RoHS; FCC;	
	Model No. GTM96600-6012-T3	
	Part No./Ordering No. TR9CE5000CCPCIMR6B	Rev B

LABEL:L-1186

LABEL P/N: Standard GT  
MATERIAL: Flat Thermal Transfer, Imprintable, Polyester Label and/or Pad Printed and/or Molded, and/or Laser Engraved in the case  
BACKGROUND COLOR: Black if housing is Black, White or Silver if housing is White or Gray.  
TEXT COLOR: White or Silver if label is Black Background for Black housing. Black if label is White or Silver background and Housing is White or Gray  
LABEL WIDTH (mm): 35.0  
LABEL HEIGHT (mm): 70.0  
SPECIAL BARCODE LABEL No  
MATERIAL: No

Below is the minimum information which will appear on the label. NOTE: in the logo area additional/actual positioning of symbols and text is subjected to change as per agency updates/requirements or additional model approvals become available.  
Regulatory certifications/label markings may be in logo area on the label or molded into the case housing outside the label area.  
Information will be shown via label and/or pad printed and/or molded and/or laser engraved in the case. \* Date code markings at GlobTek option.

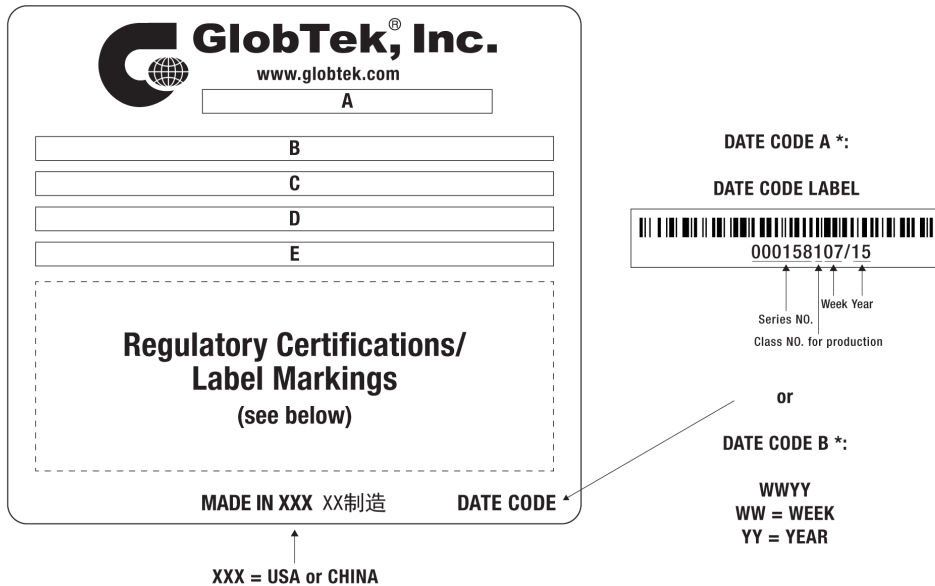

A=ITE / Medical Power Supply/Class 2/Household Power Supply  
B=P/N: (料号) TR9CE5000CCPCIMR6B  
C=Model (型号) GTM96600-6012-T3  
D=Input (输入) 100-240V~, 50-60Hz, 1.5A  
E=Output (输出) 12 V 5 A, 60.0W

AGENCY ONLINE DOCUMENTS

<http://www.globtek.info/certs/GTM96600-TZ/>

CE EC-Declaration for Medical

[http://globtek.force.com/models/ec\\_declaration?id=a0Oa00000MmCcmEAF](http://globtek.force.com/models/ec_declaration?id=a0Oa00000MmCcmEAF)

PROPRIETARY INFORMATION

PROPRIETARY OF GLOBTEK, INC. ANY REPRODUCTION, DISCLOSURE OR USE OF THIS DRAWING, IN WHOLE OR IN PART, IS HEREBY PROHIBITED EXCEPT AS SPECIFIED IN Page 10 of 14

WRITING BY GLOBTEK, INC. © GlobTek, Inc. 2016 - 2019

quest /05/20/2019 2:38:49 PM CLONED FROM TR9CE5000YL3CIMR6B

GloBtek, Inc. www.globtek.com 186 Veterans Drive, Northvale, NJ 07647 Tel. (201) 784-1000 Fax (201) 784-0111	Drawing Title: GTM96600-6012-T3, ITE / Medical Power Supply/Class 2/Household Power Supply, Efficiency Level: VI, Case Color/Style: GloBtek Black, Desktop/External, Regulated Switchmode AC-DC Power Supply AC Adaptor, Input Rating: 100-240V~, 50-60Hz, IEC 60320/C14 , Output Rating: 60W, 12V@5A, Output Configuration: 1200 mm, 16/1C + Shield Cond, UL 1185, Female Barrel 5.5*2.1*11mm WITH internal Spring Clip and Locking Notch or Equal, Ferrite: Core Size: 14.2*28.5*8.2, GloBtek Black, GT Cord # C4032, Pin Out: Center Positive (+V), Blades/Input Cord: Not Applicable, Approvals: LPS; India; IP41; CB 60335; Fuse 60335; 230V CoC Tier 2; ETL; EAC; South Africa; UL 1310; cETLus; cETLus; CB 62368; S-Mark 60950; IRAM; Ukraine; CB 60950; Class I; ETL; NOM; CCC; RCM; CB 60601-1; S-Mark IEC/EN 60601-1; ETL; cULus; Taiwan BSMI; Korea (6.3VOnly); PSE; PSE; PSE; WEEE; VCCI; CE; Level VI; China RoHS; RoHS; FCC;	
	Model No. GTM96600-6012-T3	
	Part No./Ordering No. TR9CE5000CCPCIMR6B	Rev B

CE EC-Declaration for Industrial/Commercial/ITE [http://globtek.force.com/models/ec\\_declaration?id=a0Oa000000MmCcmEAF](http://globtek.force.com/models/ec_declaration?id=a0Oa000000MmCcmEAF)  
CE EC-Declaration for Household [http://globtek.force.com/models/ec\\_declaration?id=a0Oa000000MmCcmEAF](http://globtek.force.com/models/ec_declaration?id=a0Oa000000MmCcmEAF)  
RoHS/RoHS3 Declaration [https://www.globtek.com/pdf/rohs\\_cert/01ta0000007crrQAAQ](https://www.globtek.com/pdf/rohs_cert/01ta0000007crrQAAQ)  
REACH Declaration [https://www.globtek.com/pdf/iso\\_certificates/REACH.pdf](https://www.globtek.com/pdf/iso_certificates/REACH.pdf)  
Conflict Minerals Declaration <https://www.globtek.com/pdf/conflict-minerals.pdf>  
IPXY rating is based on 3rd party testing and customers should check suitability and test system level IPXY rating before ordering.

## Regulatory Certifications/Label Markings

LATEST PRODUCT/MODEL CERTIFICATIONS: <http://en.globtek.com/datasheet/id/a0Oa000000MmCcm>  
AGENCY ONLINE DOCUMENTS: <http://www.globtek.info/certs/GTM96600-TZ/>



(E1) Earthed output



Center Positive (+V)

GloTek, Inc. www.globtek.com 186 Veterans Drive, Northvale, NJ 07647 Tel. (201) 784-1000 Fax (201) 784-0111	Drawing Title: GTM96600-6012-T3, ITE / Medical Power Supply/Class 2/Household Power Supply, Efficiency Level: VI, Case Color/Style: GlobTek Black, Desktop/External, Regulated Switchmode AC-DC Power Supply AC Adaptor, Input Rating: 100-240V~, 50-60Hz, IEC 60320/C14 , Output Rating: 60W, 12V@5A, Output Configuration: 1200 mm, 16/1C + Shield Cond, UL 1185, Female Barrel 5.5*2.1*11mm WITH internal Spring Clip and Locking Notch or Equal, Ferrite: Core Size: 14.2*28.5*8.2, GlobTek Black, GT Cord # C4032, Pin Out: Center Positive (+V), Blades/Input Cord: Not Applicable, Approvals: LPS; India; IP41; CB 60335; Fuse 60335; 230V CoC Tier 2; ETL; EAC; South Africa; UL 1310; cETLus; cETLus; CB 62368; S-Mark 60950; IRAM; Ukraine; CB 60950; Class I; ETL; NOM; CCC; RCM; CB 60601-1; S-Mark IEC/EN 60601-1; ETL; cULus; Taiwan BSMI; Korea (6.3VOnly); PSE; PSE; PSE; WEEE; VCCI; CE; Level VI; China RoHS; RoHS; FCC;	
	Model No. GTM96600-6012-T3	
	Part No./Ordering No. TR9CE5000CCPCIMR6B	Rev B

## PACKAGING

Packing Spec P/N:	Standard DT, Cellular packaging, User manual
Box Qty:	20
Gift Box Size (mm):	Egg Crate
Gift Box Color:	None
Master Carton Size (mm):	427 x 405 x 158
Master Carton Cubic Volume (m <sup>3</sup> ):	0.03
Master GW (Kg):	15.6 kg
BLADES INCLUDED:	N/A:
BLADE/CORD INSTALLED:	N/A:
USER MANUAL:	809-DESKTOPUSERMANUAL
USER MANUAL WEB LINK:	<a href="https://en.globtek.com/pdf/809-DESKTOPUSERMANUA...">https://en.globtek.com/pdf/809-DESKTOPUSERMANUA...</a>

If specific packaging is required, this section must specify all requirements and note "no exceptions". If this section does not specify packaging, it is subject to change without notice at GlobTek's discretion.

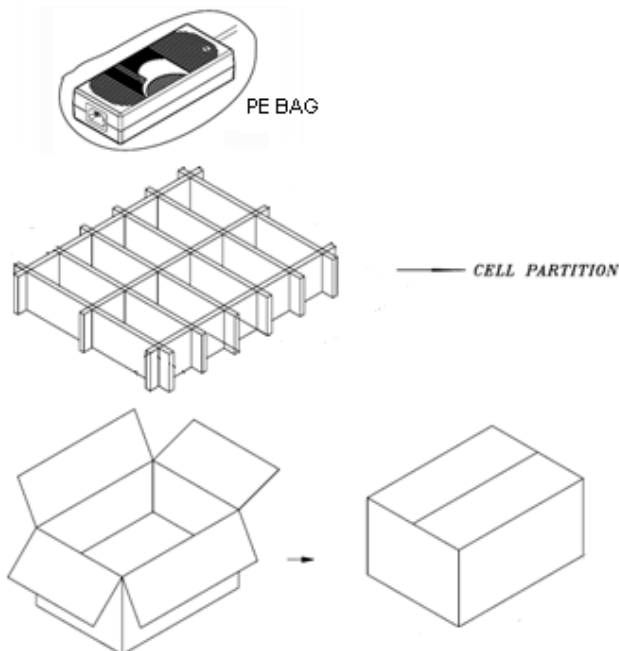

### PROPRIETARY INFORMATION

<p>GlobTek, Inc. www.globtek.com 186 Veterans Drive, Northvale, NJ 07647 Tel. (201) 784-1000 Fax (201) 784-0111</p>	<p>Drawing Title: GTM96600-6012-T3, ITE / Medical Power Supply/Class 2/Household Power Supply, Efficiency Level: VI, Case Color/Style: GlobTek Black, Desktop/External, Regulated Switchmode AC-DC Power Supply AC Adaptor, Input Rating: 100-240V~, 50-60Hz, IEC 60320/C14 , Output Rating: 60W, 12V@5A, Output Configuration: 1200 mm, 16/1C + Shield Cond, UL 1185, Female Barrel 5.5*2.1*11mm WITH internal Spring Clip and Locking Notch or Equal, Ferrite: Core Size: 14.2*28.5*8.2, GlobTek Black, GT Cord # C4032, Pin Out: Center Positive (+V), Blades/Input Cord: Not Applicable, Approvals: LPS; India; IP41; CB 60335; Fuse 60335; 230V CoC Tier 2; ETL; EAC; South Africa; UL 1310; cETLus; cETLus; CB 62368; S-Mark 60950; IRAM; Ukraine; CB 60950; Class I; ETL; NOM; CCC; RCM; CB 60601-1; S-Mark IEC/EN 60601-1; ETL; cULus; Taiwan BSMI; Korea (6.3VOnly); PSE; PSE; PSE; WEEE; VCCI; CE; Level VI; China RoHS; RoHS; FCC;</p>		
	<p>Model No. GTM96600-6012-T3</p>		
	<table border="1"> <tr> <td data-bbox="305 357 1380 399">Part No./Ordering No. TR9CE5000CCPCIMR6B</td> <td data-bbox="1380 357 1547 399">Rev B</td> </tr> </table>	Part No./Ordering No. TR9CE5000CCPCIMR6B	Rev B
Part No./Ordering No. TR9CE5000CCPCIMR6B	Rev B		

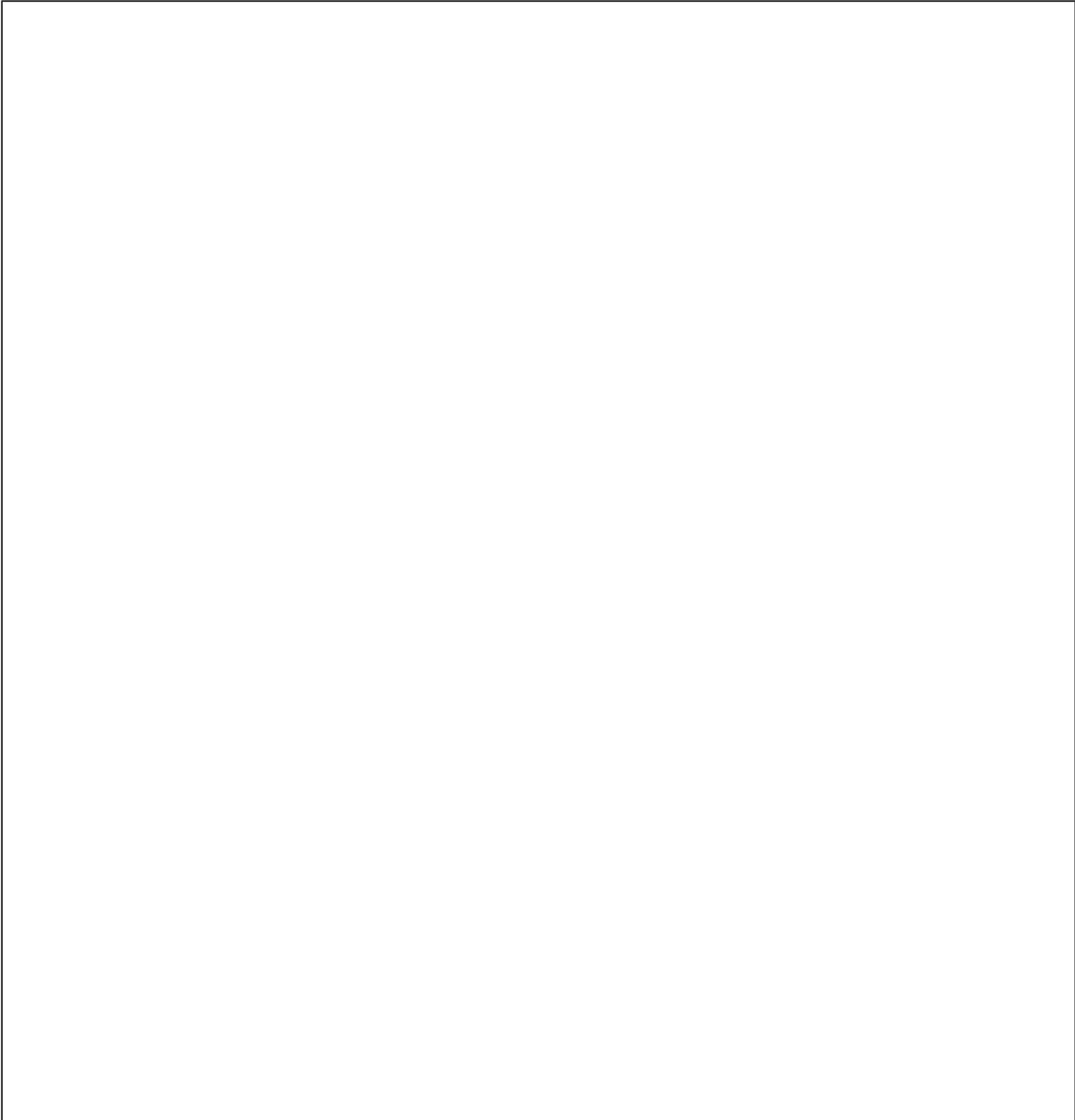

GloTek, Inc. www.globtek.com 186 Veterans Drive, Northvale, NJ 07647 Tel. (201) 784-1000 Fax (201) 784-0111	Drawing Title: GTM96600-6012-T3, ITE / Medical Power Supply/Class 2/Household Power Supply, Efficiency Level: VI, Case Color/Style: GlobTek Black, Desktop/External, Regulated Switchmode AC-DC Power Supply AC Adaptor, Input Rating: 100-240V~, 50-60Hz, IEC 60320/C14 , Output Rating: 60W, 12V@5A, Output Configuration: 1200 mm, 16/1C + Shield Cond, UL 1185, Female Barrel 5.5*2.1*11mm WITH internal Spring Clip and Locking Notch or Equal, Ferrite: Core Size: 14.2*28.5*8.2, GlobTek Black, GT Cord # C4032, Pin Out: Center Positive (+V), Blades/Input Cord: Not Applicable, Approvals: LPS; India; IP41; CB 60335; Fuse 60335; 230V CoC Tier 2; ETL; EAC; South Africa; UL 1310; cETLus; cETLus; CB 62368; S-Mark 60950; IRAM; Ukraine; CB 60950; Class I; ETL; NOM; CCC; RCM; CB 60601-1; S-Mark IEC/EN 60601-1; ETL; cULus; Taiwan BSMI; Korea (6.3VOnly); PSE; PSE; PSE; WEEE; VCCI; CE; Level VI; China RoHS; RoHS; FCC;	
	Model No. GTM96600-6012-T3	
	Part No./Ordering No. TR9CE5000CCPCIMR6B	Rev B

## INSTRUCTIONS TO THE OEM SYSTEMS ENGINEER

It is the responsibility of the OEM systems engineer to provide the end system user instructions and warnings for the use of this product in the end system.

If an input cord is required for this product, AC Mains voltage should be provided to the power supply by a power supply cord approved to the national standards of the country in which it will be used.

This power supply is not designed to be repaired. No serviceable parts inside. A blown internal fuse is an indication of catastrophic failure of circuit component(s). If a Failure Analysis is required for a failed power supply/battery charger, please return the damaged unit to Globtek for an accurate determination of the root cause of the failure.

EMC Compliance of the complete OEM product, including the GlobTek power supply/battery charger needs to be verified by the OEM systems engineer.

## INSTRUCTION SHEET

N/A