

GlobTek, Inc. www.globtek.com 186 Veterans Drive, Northvale, NJ 07647 Tel. (201) 784-1000 Fax (201) 784-0111	Drawing Title: GTM96180-1830-12.0-T3, ITE / Medical Power Supply/Class 2/Household Power Supply, Efficiency Level: VI, Case Color/Style: GlobTek Black, Desktop/External, Regulated Switchmode AC-DC Power Supply AC Adaptor, Input Rating: 100-240V~, 50-60 Hz, IEC 60320/C14 , Output Rating: 18W, 18V@1A, Output Configuration: 1500 mm, 18/1C + Shield Cond, UL 1185, Female Barrel 5.5 * 2.5 * 11mm with internal Spring Clip and Locking Notch or Equal, Ferrite: None, GlobTek Black, GT Cord # C5101, Pin Out: Center Positive (+V), Blades/Input Cord: (Order Separately), Approvals: Taiwan BSMI; IP42; RCM; CB 60601-1; cETLus 60601-1 3rd; cETLus; CAN ICES-3; FCC; PSE; PSE; WEEE; VCCI; Ukraine; RoHS; LPS; Level VI; China RoHS; CE; Fuse 60335; CB 62368; CB 60950; Class I; 230V CoC Tier 2; cULus; Korea (12V Only); EAC; NOM; S-Mark 60950;ETL; CCC; CE; IRAM; CB 60335; cETLus UL1310; Fuse 60335;	
	Model No. GTM96180-1830-12.0-T3	
	Part No./Ordering No. TR9CH1000LCP-IM-R6B	Rev B

## REVISION HISTORY

REV	DESCRIPTION	SUB	DATE	APPROVED
B	Updated plug from 5.5 * 2.1 to 5.5 * 2.5	fclif	10/30/2018	QA
A	Initial Release	bsiep	02/23/2017	QA

In Addition to GlobTek Inc.'s renewed ISO9001:2015 - Quality Management System Certification, GlobTek Inc. is now certified to:

ISO13485:2016 - Medical Devices Quality Management System Certification

ISO14001:2015 - Environmental Management System Certification

ISO Certificates are available online at <https://www.globtek.com/iso-certificates/>

### Customer Approval of Specification:

Please approve, sign and send back to GlobTek so we can complete order processing.

A delay in receipt of this form will delay delivery schedule.

Company Name:

Customer P/N:

Quote Number:

Date:

Authorized Representative Name:

Authorized Representative Signature:

The acceptance of this specification and use of the product described in this document indicates the acceptance and binding of the customer to Globtek terms and conditions, which supersede all other agreements, terms, and conditions (<https://en.globtek.com/terms-and-conditions/>).

### Footnote:

GlobTek Inc. will not be liable for the safety and performance of these power supplies if unauthorized access and repair occurs. End user should consult applicable UL, CSA or EN standards for proper installation instruction.

### Limitation of Use:

GlobTek products are intended for use with commercial, medical, and/or industrial equipment only. GlobTek product are not authorized for use as mission critical components in life support hazardous environment, nuclear or aircraft applications without prior written approval from the CEO of GlobTek Inc.

Contents of this document are subject to change without prior notice.

<b>GlobTek, Inc.</b> www.globtek.com 186 Veterans Drive, Northvale, NJ 07647 Tel. (201) 784-1000 Fax (201) 784-0111	Drawing Title: GTM96180-1830-12.0-T3, ITE / Medical Power Supply/Class 2/Household Power Supply, Efficiency Level: VI, Case Color/Style: GlobTek Black, Desktop/External, Regulated Switchmode AC-DC Power Supply AC Adaptor, Input Rating: 100-240V~, 50-60 Hz, IEC 60320/C14 , Output Rating: 18W, 18V@1A, Output Configuration: 1500 mm, 18/1C + Shield Cond, UL 1185, Female Barrel 5.5 * 2.5 * 11mm with internal Spring Clip and Locking Notch or Equal, Ferrite: None, GlobTek Black, GT Cord # C5101, Pin Out: Center Positive (+V), Blades/Input Cord: (Order Separately), Approvals: Taiwan BSMI; IP42; RCM; CB 60601-1; cETLus 60601-1 3rd; cETLus; CAN ICES-3; FCC; PSE; PSE; WEEE; VCCI; Ukraine; RoHS; LPS; Level VI; China RoHS; CE; Fuse 60335; CB 62368; CB 60950; Class I; 230V CoC Tier 2; cULus; Korea (12V Only); EAC; NOM; S-Mark 60950;ETL; CCC; CE; IRAM; CB 60335; cETLus UL1310; Fuse 60335;	
	Model No. GTM96180-1830-12.0-T3	
	Part No./Ordering No. TR9CH1000LCP-IM-R6B	Rev B

## POWER SUPPLY INFORMATION

**TYPE:** Desktop/External  
**TECHNOLOGY:** Regulated Switchmode AC-DC Power Supply AC Adaptor  
**CASE COLOR:** GlobTek Black  
**NAMEPLATE RATED INPUT:** 100-240V~, 50-60 Hz, 0.6 A  
**INPUT CONFIG:** IEC 60320/C14  
**WATTS:** 18.0  
**VOLTS OUT:** 18  
**CURRENT OUT (Amps):** 1  
**BLADE/CORD INCLUDED:** None  
**BLADE/CORD INSTALLED:** None  
**INGRESS PROTECTION:** IP42  
**GROUNDING CONFIGURATION:** (E1) Earthed output  
**EFFICIENCY LEVEL:** VI  
**OUTPUT CONFIGURATION:** 1500 mm, 18/1C + Shield Cond, UL 1185, Female Barrel 5.5 \* 2.5 \* 11mm with internal Spring Clip and Locking Notch or Equal, Ferrite: None, GlobTek Black, GT Cord # C5101  
**OVERMOLDED:** Yes  
**CONNECTOR PIN OUT:** Center Positive (+V)  
**LABEL SPECS:** Standard GT,L-1186  
**SPECIAL BARCODE LABEL**  
**MATERIAL:**  
**PACK SPEC:** Standard DT, Individually Box, GT User Manual  
**USER MANUAL:** 809-DESKTOPUSERMANUAL on A4 paper

Notes/Modifications/Customizations (notes in this section supersede the values shown in the standard spec):

DIMENSIONS ARE IN MM UNLESS SPECIFIED OTHERWISE.

### PROPRIETARY INFORMATION

PROPRIETARY OF GLOBTEK, INC. ANY REPRODUCTION, DISCLOSURE OR USE OF THIS DRAWING, IN WHOLE OR IN PART, IS HEREBY PROHIBITED EXCEPT AS SPECIFIED IN

WRITING BY GLOBTEK, INC. © GlobTek, Inc. 2017 - 2019

quest /09/19/2019 11:36:48 PM CLONED FROM TR9CH1000LCP-Y-MED/R

GlobTek, Inc. www.globtek.com 186 Veterans Drive, Northvale, NJ 07647 Tel. (201) 784-1000 Fax (201) 784-0111	Drawing Title: GTM96180-1830-12.0-T3, ITE / Medical Power Supply/Class 2/Household Power Supply, Efficiency Level: VI, Case Color/Style: GlobTek Black, Desktop/External, Regulated Switchmode AC-DC Power Supply AC Adaptor, Input Rating: 100-240V~, 50-60 Hz, IEC 60320/C14 , Output Rating: 18W, 18V@1A, Output Configuration: 1500 mm, 18/1C + Shield Cond, UL 1185, Female Barrel 5.5 * 2.5 * 11mm with internal Spring Clip and Locking Notch or Equal, Ferrite: None, GlobTek Black, GT Cord # C5101, Pin Out: Center Positive (+V), Blades/Input Cord: (Order Separately), Approvals: Taiwan BSMI; IP42; RCM; CB 60601-1; cETLus 60601-1 3rd; cETLus; CAN ICES-3; FCC; PSE; PSE; WEEE; VCCI; Ukraine; RoHS; LPS; Level VI; China RoHS; CE; Fuse 60335; CB 62368; CB 60950; Class I; 230V CoC Tier 2; cULus; Korea (12V Only); EAC; NOM; S-Mark 60950;ETL; CCC; CE; IRAM; CB 60335; cETLus UL1310; Fuse 60335;	
	Model No. GTM96180-1830-12.0-T3	
	Part No./Ordering No. TR9CH1000LCP-IM-R6B	Rev B

## ELECTRICAL SPECIFICATIONS

### A) ELECTRICAL SPECIFICATIONS:

01. Input Voltage: Specified 90-264 Vac, Nameplate rated: 100-240Vac
  - 90-264 Vac range @ 100% of rated load current
  - 85-264 Vac range @ 85% of rated load current
  - 110-370 VDC range @ 100% of rated load current
02. Input Frequency: Specified 47-63 Hz, Nameplate rated 50-60Hz
03. Output Regulation: +/- 5% measured at the output connector
04. Line Voltage Regulation: +/- 0.5% typical measured at full load
05. Green Power On Indicator LED
06. Output Ripple (Vp-p): 1% or 100 mV whichever is greater, measured at 20 MHz bandwidth with 0.1 uf ceramic capacitor in parallel with a low impedance 47 uf electrolytic capacitor connected at the end of the output connector
07. Turn-ON/OFF Overshoot: 5% maximum, 1 mS typical recovery time for 40% to 70% step load
08. Turn-ON Delay: 1 second maximum @ full load, nominal line
09. Hold-Up Time: 8 mS typical @ nominal input voltage and full load
10. Inrush Current: 30A/60A maximum cold start @ 115/230Vac input
11. Efficiency: Compliant with Efficiency Level VI and CoC Tier 2 standards
12. No Load Standby Power: <0.075 W @ 230Vac

### B) PROTECTION

01. Input Protection: Input line fusing and 300Vac MOV
02. Short Circuit/ Overload: Electronically Protected unit will auto recover upon removal of fault
  - Output Current Limit: 110% to 160% of rated output current
  - (upper end of current limit range is determined by normal output power rating, not derated output power level)
03. Output Over-Voltage: 110% to 130% of nominal output voltage

### C) SAFETY

01. Dielectric Withstand Voltage: 4000Vac or 5656Vdc from input to output, On Class I models, 3000Vac or 4242Vdc from input to earth
02. Earth Leakage Current: Class I models < 300uA, N/A for Class II models
03. Touch Current: Class I models < 20uA, Class II models < 75uA  
(special < 10uA option available, see SPECIAL OPTIONS section below)
04. Output Floating or Earthed option for Class I desktop models.  
See [Output Isolation Options](#) for details
05. Earth Continuity Test: < 0.1 Ohm between Earth Pin at AC input and PCB termination point (Class I models only)
06. Means of Protection: 2 x MOPP
07. Compliant Standards: See listings at end of this drawing for specifics

### D) EMC

- EN 60601-1-2, 4<sup>th</sup> edition  
Emissions, per EN 55032, EN 61000-6-3, EN 61000-6-4, CISPR11 and CISPR22  
Conducted Emissions: Class B, FCC Part 15, Class B  
Radiated Emissions: Class B, FCC Part 15, Class B  
Line Frequency Harmonics EN61000-3-2, Class A  
Voltage Fluctuations/Flicker EN61000-3-3

#### PROPRIETARY INFORMATION

PROPRIETARY OF GLOBTEK, INC. ANY REPRODUCTION, DISCLOSURE OR USE OF THIS DRAWING, IN WHOLE OR IN PART, IS HEREBY PROHIBITED EXCEPT AS SPECIFIED IN

WRITING BY GLOBTEK, INC. © GlobTek, Inc. 2017 - 2019

quest /09/19/2019 11:36:48 PM CLONED FROM TR9CH1000LCP-Y-MED/R

GlobTek, Inc. www.globtek.com 186 Veterans Drive, Northvale, NJ 07647 Tel. (201) 784-1000 Fax (201) 784-0111	Drawing Title: GTM96180-1830-12.0-T3, ITE / Medical Power Supply/Class 2/Household Power Supply, Efficiency Level: VI, Case Color/Style: GlobTek Black, Desktop/External, Regulated Switchmode AC-DC Power Supply AC Adaptor, Input Rating: 100-240V~, 50-60 Hz, IEC 60320/C14 , Output Rating: 18W, 18V@1A, Output Configuration: 1500 mm, 18/1C + Shield Cond, UL 1185, Female Barrel 5.5 * 2.5 * 11mm with internal Spring Clip and Locking Notch or Equal, Ferrite: None, GlobTek Black, GT Cord # C5101, Pin Out: Center Positive (+V), Blades/Input Cord: (Order Separately), Approvals: Taiwan BSMI; IP42; RCM; CB 60601-1; cETLus 60601-1 3rd; cETLus; CAN ICES-3; FCC; PSE; PSE; WEEE; VCCI; Ukraine; RoHS; LPS; Level VI; China RoHS; CE; Fuse 60335; CB 62368; CB 60950; Class I; 230V CoC Tier 2; cULus; Korea (12V Only); EAC; NOM; S-Mark 60950;ETL; CCC; CE; IRAM; CB 60335; cETLus UL1310; Fuse 60335;	
	Model No. GTM96180-1830-12.0-T3	
	Part No./Ordering No. TR9CH1000LCP-IM-R6B	Rev B

Immunity, per EN 55024, EN 61000-6-1, EN 61000-6-2

Static Discharge Immunity EN61000-4-2, 10kV Contact Discharge, 20kV air discharge

Radiated RF Immunity EN61000-4-3, 10V/m 80-1000MHz, 3V/m 1-2.7GHz, 80% 1KHz AM.

EFT/Burst Immunity EN61000-4-4, 4kV/100kHz.

Line Surge Immunity EN61000-4-5, 2kV differential, 4kV common-mode

Conducted RF Immunity EN61000-4-6, 3Vrms, 80% 1KHz AM

Power Frequency Magnetic Field Immunity EN61000-4-8, 3A/m

Voltage Dip Immunity EN61000-4-11, Criteria

E) OTHER:

01. MTBF: 1,000,000 Hours @ 40°C ambient temperature, Full Load

02. GTM96180 Family: -10°C to 40°C ambient temperature with full load

Regarding Operating Temperature,

a- See below derating table for output power capability at alternate temperature

b- Extended low end temperature range available as custom option

03. Operating Humidity: 0% to 95% relative humidity, non-condensing

04. Storage Temperature: -30°C to 80°C

05. Operating Altitude: 5000 Meters

06. ROHS: Compliant with latest regulations, see approvals section below

F) ENCLOSURE

01. Housing: High impact plastic, 94V0 polycarbonate, non-vented

02. Markings: Label or Laser Printed

03. AC Input mechanical options: Class II Wall Plug-in, Changeable Blades  
Desktop Option, extended housing: C6, C8, C14 or C18 IEC Inlet.

G) SPECIAL OPTIONS

01. Cost reduction, removal of LED

02. Custom Cordsets, various cordage types, and connector types\*

03. Custom Markings

04. Short term Output Surge Capability

05. Reduced Leakage Current versions (10uA max), for CF medical applications, and AC noise sensitive equipment, 15W or less, 5V to 24V output voltage range.

06. Tightened output voltage tolerance

07. Reduced output ripple level

08. Reduced output power rating marking

09. High Rel PCB laminate with Plated through Holes for IPC610 Class 2 Compliance

10. Special Housing Colors and Cordset Colors

11. Quasi Constant Current Output, for Battery Charger Applications

12. Tamper proof, AC Wall Plug-in blade assembly. Requires a special tool to remove the AC Wall Plug-in blade assembly.

13. Back EMF applications, custom solutions. For unusual motor load apps and other high inductance reverse energy flow requirements.

14. Improved Ingress Protection Rating

\* 5Vdc USB output connector power supplies, which use the Micro-B or C-type style connector, have a max output voltage regulation specification of +/-8% (4.6V to 5.4V range).

INGRESS PROTECTION: IP42

PROPRIETARY INFORMATION

PROPRIETARY OF GLOBTEK, INC. ANY REPRODUCTION, DISCLOSURE OR USE OF THIS DRAWING, IN WHOLE OR IN PART, IS HEREBY PROHIBITED EXCEPT AS SPECIFIED IN

WRITING BY GLOBTEK, INC. © GlobTek, Inc. 2017 - 2019

quest/09/19/2019 11:36:48 PM CLONED FROM TR9CH1000LCP-Y-MED/R

<p>GlobTek, Inc.  www.globtek.com  186 Veterans Drive,  Northvale, NJ 07647  Tel. (201) 784-1000  Fax (201) 784-0111</p>	<p>Drawing Title: GTM96180-1830-12.0-T3, ITE / Medical Power Supply/Class 2/Household Power Supply, Efficiency Level: VI, Case Color/Style: GlobTek Black, Desktop/External, Regulated Switchmode AC-DC Power Supply AC Adaptor, Input Rating: 100-240V~, 50-60 Hz, IEC 60320/C14 , Output Rating: 18W, 18V@1A, Output Configuration: 1500 mm, 18/1C + Shield Cond, UL 1185, Female Barrel 5.5 * 2.5 * 11mm with internal Spring Clip and Locking Notch or Equal, Ferrite: None, GlobTek Black, GT Cord # C5101, Pin Out: Center Positive (+V), Blades/Input Cord: (Order Separately), Approvals: Taiwan BSMI; IP42; RCM; CB 60601-1; cETLus 60601-1 3rd; cETLus; CAN ICES-3; FCC; PSE; PSE; WEEE; VCCI; Ukraine; RoHS; LPS; Level VI; China RoHS; CE; Fuse 60335; CB 62368; CB 60950; Class I; 230V CoC Tier 2; cULus; Korea (12V Only); EAC; NOM; S-Mark 60950;ETL; CCC; CE; IRAM; CB 60335; cETLus UL1310; Fuse 60335;</p>
<p>Model No. GTM96180-1830-12.0-T3</p>	
<p>Part No./Ordering No. TR9CH1000LCP-IM-R6B</p>	<p>Rev B</p>

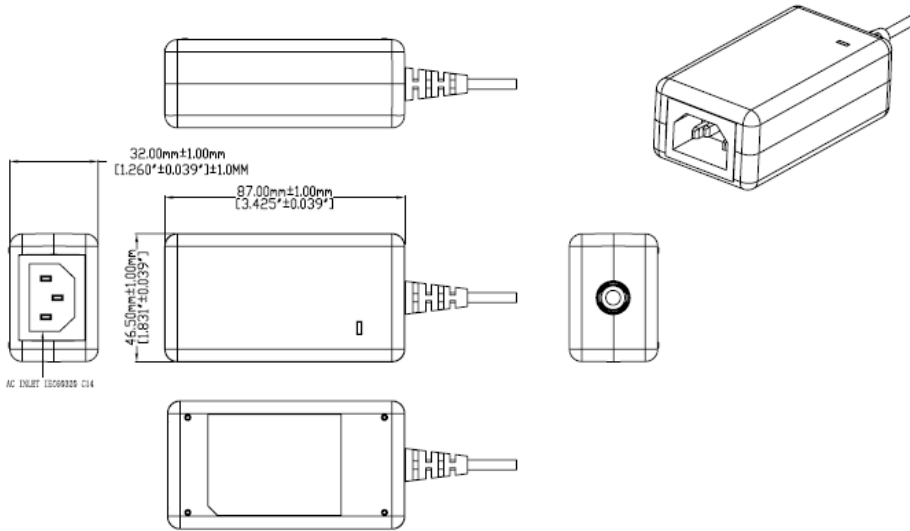

DERATING CURVE

GlobTek, Inc. www.globtek.com 186 Veterans Drive, Northvale, NJ 07647 Tel. (201) 784-1000 Fax (201) 784-0111	Drawing Title: GTM96180-1830-12.0-T3, ITE / Medical Power Supply/Class 2/Household Power Supply, Efficiency Level: VI, Case Color/Style: GlobTek Black, Desktop/External, Regulated Switchmode AC-DC Power Supply AC Adaptor, Input Rating: 100-240V~, 50-60 Hz, IEC 60320/C14 , Output Rating: 18W, 18V@1A, Output Configuration: 1500 mm, 18/1C + Shield Cond, UL 1185, Female Barrel 5.5 * 2.5 * 11mm with internal Spring Clip and Locking Notch or Equal, Ferrite: None, GlobTek Black, GT Cord # C5101, Pin Out: Center Positive (+V), Blades/Input Cord: (Order Separately), Approvals: Taiwan BSMI; IP42; RCM; CB 60601-1; cETLus 60601-1 3rd; cETLus; CAN ICES-3; FCC; PSE; PSE; WEEE; VCCI; Ukraine; RoHS; LPS; Level VI; China RoHS; CE; Fuse 60335; CB 62368; CB 60950; Class I; 230V CoC Tier 2; cULus; Korea (12V Only); EAC; NOM; S-Mark 60950;ETL; CCC; CE; IRAM; CB 60335; cETLus UL1310; Fuse 60335;	
	Model No. GTM96180-1830-12.0-T3	
	Part No./Ordering No. TR9CH1000LCP-IM-R6B	Rev B

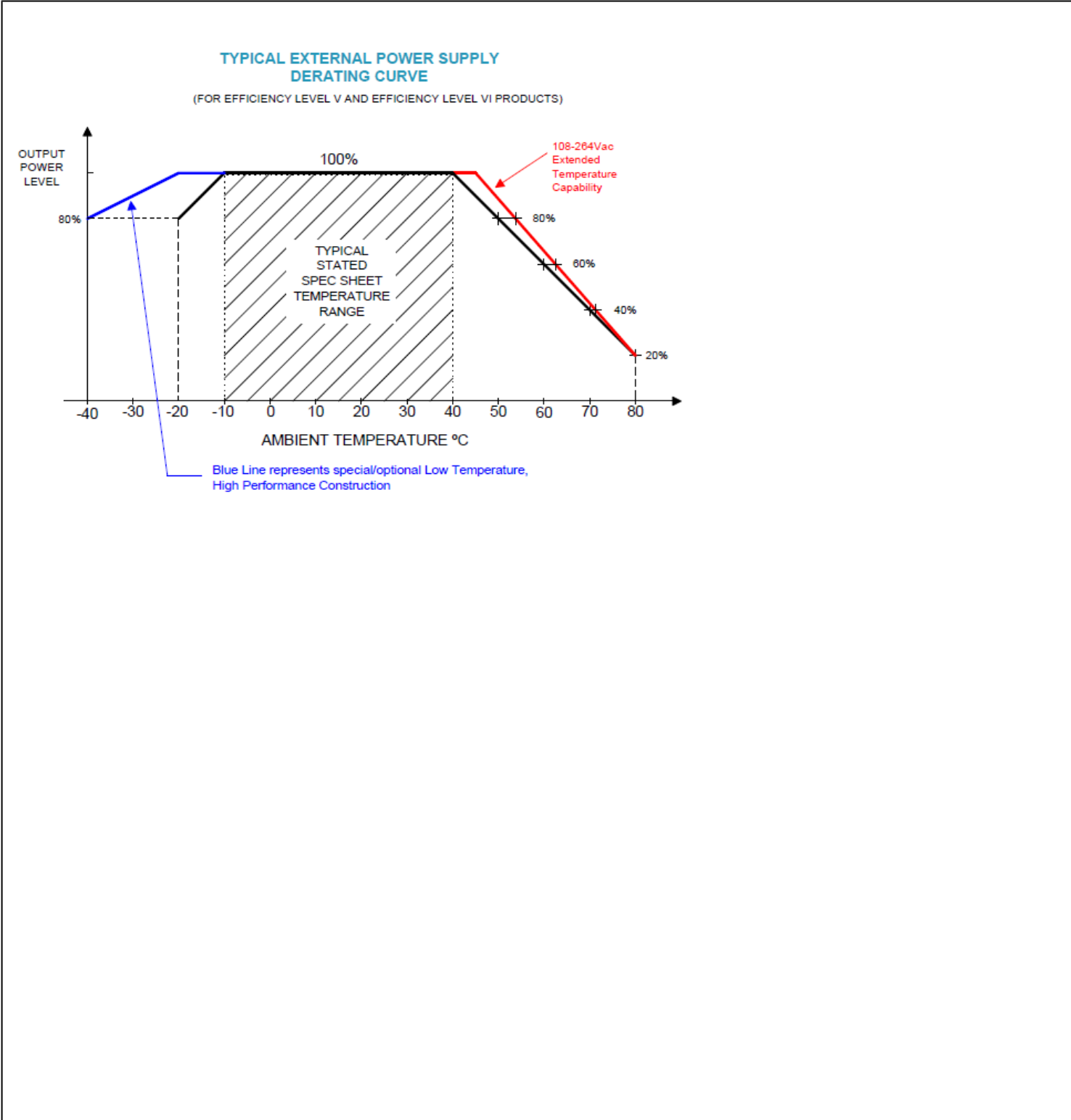

GlobTek, Inc. www.globtek.com 186 Veterans Drive, Northvale, NJ 07647 Tel. (201) 784-1000 Fax (201) 784-0111	Drawing Title: GTM96180-1830-12.0-T3, ITE / Medical Power Supply/Class 2/Household Power Supply, Efficiency Level: VI, Case Color/Style: GlobTek Black, Desktop/External, Regulated Switchmode AC-DC Power Supply AC Adaptor, Input Rating: 100-240V~, 50-60 Hz, IEC 60320/C14 , Output Rating: 18W, 18V@1A, Output Configuration: 1500 mm, 18/1C + Shield Cond. UL 1185, Female Barrel 5.5 * 2.5 * 11mm with internal Spring Clip and Locking Notch or Equal, Ferrite: None, GlobTek Black, GT Cord # C5101, Pin Out: Center Positive (+V), Blades/Input Cord: (Order Separately), Approvals: Taiwan BSMI; IP42; RCM; CB 60601-1; cETLus 60601-1 3rd; cETLus; CAN ICES-3; FCC; PSE; PSE; WEEE; VCCI; Ukraine; RoHS; LPS; Level VI; China RoHS; CE; Fuse 60335; CB 62368; CB 60950; Class I; 230V CoC Tier 2; cULus; Korea (12V Only); EAC; NOM; S-Mark 60950;ETL; CCC; CE; IRAM; CB 60335; cETLus UL1310; Fuse 60335;	
	Model No. GTM96180-1830-12.0-T3	
	Part No./Ordering No. TR9CH1000LCP-IM-R6B	Rev B

### INPUT CONFIGURATION

(E1) Earthed output

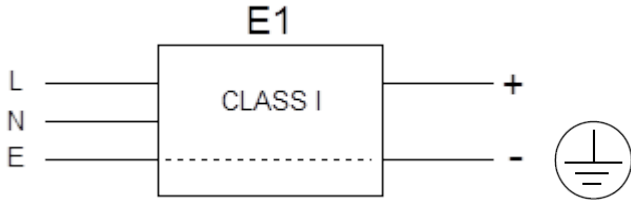

[Alternate grounding configurations](#) available upon request.

Blades/Cord Included:None:

Blades/Cord Installed:None:

IEC 60320/C14 AC Inlet Connector, Class I, Earth Ground

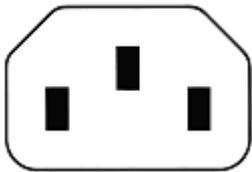

Mates with IEC 60320/C13 Plug

Optional Locking IEC60320 Receptable and cord option available on some models by request.:



### [Standard International IEC 320/C13 Cordsets](#)

Below are standard cordsets which are "not included" (unless stated above); these can be purchased separately or packaged with the power supply. Contact your Sales Engineer if the style required is not shown below. Many more available in different lengths, colors or cable material.

### Stock Power Supply Cords

Part Number/ Link	Country	Plug	Termination	Length (mm)	(Ft)
<a href="#">3021457F701(R)</a>	N. American (Type B)	NEMA 5-15P	IEC 320/C13	2150	7

PROPRIETARY INFORMATION

PROPRIETARY OF GLOBTEK, INC. ANY REPRODUCTION, DISCLOSURE OR USE OF THIS DRAWING, IN WHOLE OR IN PART, IS HEREBY PROHIBITED EXCEPT AS SPECIFIED IN

WRITING BY GLOBTEK, INC. © GlobTek, Inc. 2017 - 2019

quest /09/19/2019 11:36:48 PM CLONED FROM TR9CH1000LCP-Y-MED/R

GlobTek, Inc. www.globtek.com 186 Veterans Drive, Northvale, NJ 07647 Tel. (201) 784-1000 Fax (201) 784-0111	Drawing Title: GTM96180-1830-12.0-T3, ITE / Medical Power Supply/Class 2/Household Power Supply, Efficiency Level: VI, Case Color/Style: GlobTek Black, Desktop/External, Regulated Switchmode AC-DC Power Supply AC Adaptor, Input Rating: 100-240V~, 50-60 Hz, IEC 60320/C14 , Output Rating: 18W, 18V@1A, Output Configuration: 1500 mm, 18/1C + Shield Cond, UL 1185, Female Barrel 5.5 * 2.5 * 11mm with internal Spring Clip and Locking Notch or Equal, Ferrite: None, GlobTek Black, GT Cord # C5101, Pin Out: Center Positive (+V), Blades/Input Cord: (Order Separately), Approvals: Taiwan BSMI; IP42; RCM; CB 60601-1; cETLus 60601-1 3rd; cETLus; CAN ICES-3; FCC; PSE; PSE; WEEE; VCCI; Ukraine; RoHS; LPS; Level VI; China RoHS; CE; Fuse 60335; CB 62368; CB 60950; Class I; 230V CoC Tier 2; cULus; Korea (12V Only); EAC; NOM; S-Mark 60950;ETL; CCC; CE; IRAM; CB 60335; cETLus UL1310; Fuse 60335;	
	Model No. GTM96180-1830-12.0-T3	
	Part No./Ordering No. TR9CH1000LCP-IM-R6B	Rev B

<a href="#">1191068F0701(R)</a>	N. American (Type B)	NEMA 5-15P Hospital	IEC 320/C13	2459	8
<a href="#">2194272M5701-T(R)</a>	Argentina (Type I)	IRAM 2073	IEC 320/C13	2500	8
<a href="#">5502022M5701A(R)</a>	Australian (Type I)	AS3112 / 3 PRONG	IEC 320/C13	2500	8
<a href="#">204B4272M5701(R)</a>	Brazil (Type N)	BRAZIL	IEC 320/C13	2500	8
<a href="#">6023602M5701(R)</a>	China (Type I)	CCC GR2099	IEC 320/C13	2500	8
<a href="#">G8014272M5701(R)</a>	Danish (Type K)	AFSNIT SECTION 107-2-D1	IEC 320/C13	2500	8
<a href="#">23144272M5701-T(R)</a>	Europe (Type E)	CEE 7/7	IEC 320/C13	2500	8
<a href="#">205IN4272M5701(R)</a>	India (Type D)	India IS 1293 (also known as IA16A3 or BS546)	IEC 320/C13	2500	8
<a href="#">208IN4272M5701(R)</a>	India (Type M)	India IS 1293 (also known as IA16A3 or BS546)	IEC320/C13	2500	8
<a href="#">377C4272M5701(R)</a>	Israel (Type H)	ISL 377C	IEC 320/C13	2500	8
<a href="#">23024272M5701(R)</a>	Italy (Type L)	CEI 23-16/VII	IEC 320/C13	2500	8
<a href="#">3003339F701(R)</a> [3x1.25mm2]	Japan (Type B)	JIS 8303 / 3 PINS	IEC 320/C13	2500	8
<a href="#">3003068F2701-HK(R)</a> [3 x 2.0mm2]					
<a href="#">302J115J6F0701J(R)</a>	Japan / North America (Type B – 12A)	JIS 8303 / 3 PINS and NEMA 5-15P (PSE and UL/CUL appr)	IEC 320/C13	1830	6
<a href="#">302J104J6F0701J(R)</a>	Japan / North America (Type B – 15A)	JIS 8303 / 3 PINS and NEMA 5-15P (PSE and UL/CUL appr)	IEC 320/C13	1830	6
<a href="#">2313K3432M5701(R)</a>	Korea (Type F)	KS C 8305	IEC 320/C13	2500	8
<a href="#">5804272M5701(R)</a>	Russia (Type F)	GOST 7396	IEC 320/C13	2500	8
<a href="#">2084272M5701(R)</a>	South Africa (Type M)	South Africa SABS164-1 (16A type)	IEC 320/C13	2500	8
<a href="#">23214272M5701(R)</a>	Switzerland (Type J)	SEV 1011	IEC 320/C13	2500	8
<a href="#">3003322M5701(R)</a>	Taiwan (Type B)	BSMI	IEC 320/C13	2500	8
<a href="#">PZ0800100-2M5BK13H(R)</a>	UK, Hong Kong, Singapore, Gulf States (Type G)	BS 1363A	IEC 320/C13	2500	8
<a href="#">7055002M5701A(R)</a>	International	IEC 320 C14-C13	IEC 320/C13	2500	8



GlobTek, Inc. www.globtek.com 186 Veterans Drive, Northvale, NJ 07647 Tel. (201) 784-1000 Fax (201) 784-0111	Drawing Title: GTM96180-1830-12.0-T3, ITE / Medical Power Supply/Class 2/Household Power Supply, Efficiency Level: VI, Case Color/Style: GlobTek Black, Desktop/External, Regulated Switchmode AC-DC Power Supply AC Adaptor, Input Rating: 100-240V~, 50-60 Hz, IEC 60320/C14 , Output Rating: 18W, 18V@1A, Output Configuration: 1500 mm, 18/1C + Shield Cond, UL 1185, Female Barrel 5.5 * 2.5 * 11mm with internal Spring Clip and Locking Notch or Equal, Ferrite: None, GlobTek Black, GT Cord # C5101, Pin Out: Center Positive (+V), Blades/Input Cord: (Order Separately), Approvals: Taiwan BSMI; IP42; RCM; CB 60601-1; cETLus 60601-1 3rd; cETLus; CAN ICES-3; FCC; PSE; PSE; WEEE; VCCI; Ukraine; RoHS; LPS; Level VI; China RoHS; CE; Fuse 60335; CB 62368; CB 60950; Class I; 230V CoC Tier 2; cULus; Korea (12V Only); EAC; NOM; S-Mark 60950;ETL; CCC; CE; IRAM; CB 60335; cETLus UL1310; Fuse 60335;	
	Model No. GTM96180-1830-12.0-T3	
	Part No./Ordering No. TR9CH1000LCP-IM-R6B	Rev B

**OUTPUT CORD AND CONNECTOR: LCL/C5101**

ACTUAL CONNECTORS, OVERMOLDS, FERRITES MAY VARY SLIGHTLY FROM THE PICTURE BELOW

CABLE TYPE	UL 1185
CABLE LENGTH (mm)	1500
CABLE TOLERANCE (mm)	+150, -0
WIRE GAUGE (AWG)	18
CONDUCTORS	1C + Shield
HANK DIMENSION (mm)	80 ± 20
CABLE / CONNECTOR OVERMOLD COLOR	GlobTek Black
FERRITE TYPE / DIMENSION	None
FERRITE # OF TURNS <a href="#">(Definition)</a>	N/A
FERRITE DIMENSION FROM STRAIN RELIEF	N/A
FERRITE DIMENSION FROM PLUG	N/A
PLUG TYPE	Female Barrel 5.5 * 2.5 * 11mm with internal Spring Clip and Locking Notch or Equal
OUTPUT CONNECTOR SEX	
OVERMOLDED	Yes
OVER MOLD ORIENTATION	Straight
CONNECTOR PIN OUT:	Center Positive (+V)
ADDITIONAL REQUIREMENTS	

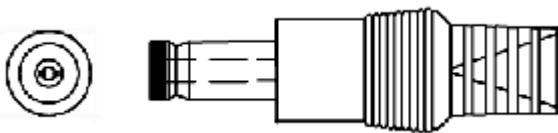

ADDITIONAL OUTPUT PLUG OPTIONS ARE AVAILABLE AT <https://www.globtek.com/connectors/>  
STANDARD PLUGS AND CONNECTORS CAN BE SEEN ONLINE AT <https://www.globtek.com/connectors/>

GlobTek, Inc. www.globtek.com 186 Veterans Drive, Northvale, NJ 07647 Tel. (201) 784-1000 Fax (201) 784-0111	Drawing Title: GTM96180-1830-12.0-T3, ITE / Medical Power Supply/Class 2/Household Power Supply, Efficiency Level: VI, Case Color/Style: GlobTek Black, Desktop/External, Regulated Switchmode AC-DC Power Supply AC Adaptor, Input Rating: 100-240V~, 50-60 Hz, IEC 60320/C14 , Output Rating: 18W, 18V@1A, Output Configuration: 1500 mm, 18/1C + Shield Cond, UL 1185, Female Barrel 5.5 * 2.5 * 11mm with internal Spring Clip and Locking Notch or Equal, Ferrite: None, GlobTek Black, GT Cord # C5101, Pin Out: Center Positive (+V), Blades/Input Cord: (Order Separately), Approvals: Taiwan BSMI; IP42; RCM; CB 60601-1; cETLus 60601-1 3rd; cETLus; CAN ICES-3; FCC; PSE; PSE; WEEE; VCCI; Ukraine; RoHS; LPS; Level VI; China RoHS; CE; Fuse 60335; CB 62368; CB 60950; Class I; 230V CoC Tier 2; cULus; Korea (12V Only); EAC; NOM; S-Mark 60950;ETL; CCC; CE; IRAM; CB 60335; cETLus UL1310; Fuse 60335;	
	Model No. GTM96180-1830-12.0-T3	
	Part No./Ordering No. TR9CH1000LCP-IM-R6B	Rev B

LABEL:L-1186

LABEL P/N: Standard GT

MATERIAL: Flat Thermal Transfer, Imprintable, Polyester Label and/or Pad Printed and/or Molded, and/or Laser Engraved in the case

BACKGROUND COLOR: Black if housing is Black, White or Silver if housing is White or Gray.

TEXT COLOR: White or Silver if label is Black Background for Black housing. Black if label is White or Silver background and Housing is White or Gray

LABEL WIDTH (mm): 36.5

LABEL HEIGHT (mm): 48.5

SPECIAL BARCODE LABEL MATERIAL:

Below is the minimum information which will appear on the label. NOTE: in the logo area additional/actual positioning of symbols and text is subjected to change as per agency updates/requirements or additional model approvals become available.

Regulatory certifications/label markings may be in logo area on the label or molded into the case housing outside the label area.

Information will be shown via label and/or pad printed and/or molded and/or laser engraved in the case. \* Date code markings at GlobTek option.

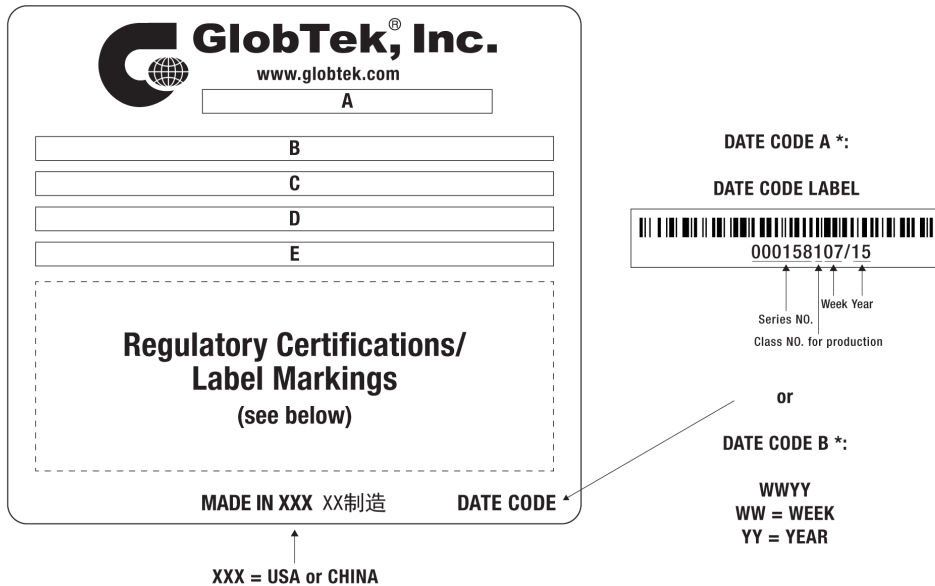

A=ITE / Medical Power Supply/Class 2/Household Power Supply



B=P/N: (料号) TR9CH1000LCP-IM-R6B

C=Model (型号) GTM96180-1830-12.0-T3

D=Input (输入) 100-240V~, 50-60 Hz, 0.6 A

E=Output (输出) 18 V  $\equiv$  1 A, 18.0W

GlobTek, Inc. www.globtek.com 186 Veterans Drive, Northvale, NJ 07647 Tel. (201) 784-1000 Fax (201) 784-0111	Drawing Title: GTM96180-1830-12.0-T3, ITE / Medical Power Supply/Class 2/Household Power Supply, Efficiency Level: VI, Case Color/Style: GlobTek Black, Desktop/External, Regulated Switchmode AC-DC Power Supply AC Adaptor, Input Rating: 100-240V~, 50-60 Hz, IEC 60320/C14 , Output Rating: 18W, 18V@1A, Output Configuration: 1500 mm, 18/1C + Shield Cond, UL 1185, Female Barrel 5.5 * 2.5 * 11mm with internal Spring Clip and Locking Notch or Equal, Ferrite: None, GlobTek Black, GT Cord # C5101, Pin Out: Center Positive (+V), Blades/Input Cord: (Order Separately), Approvals: Taiwan BSMI; IP42; RCM; CB 60601-1; cETLus 60601-1 3rd; cETLus; CAN ICES-3; FCC; PSE; PSE; WEEE; VCCI; Ukraine; RoHS; LPS; Level VI; China RoHS; CE; Fuse 60335; CB 62368; CB 60950; Class I; 230V CoC Tier 2; cULus; Korea (12V Only); EAC; NOM; S-Mark 60950;ETL; CCC; CE; IRAM; CB 60335; cETLus UL1310; Fuse 60335;	
	Model No. GTM96180-1830-12.0-T3	
	Part No./Ordering No. TR9CH1000LCP-IM-R6B	Rev B

AGENCY ONLINE DOCUMENTS	<a href="http://www.globtek.info/certs/GTM96180-TZ/">http://www.globtek.info/certs/GTM96180-TZ/</a>
CE EC-Declaration for Medical	<a href="http://globtek.force.com/models/ec_declaration?id=a0Oa000000MmbDvEAJ">http://globtek.force.com/models/ec_declaration?id=a0Oa000000MmbDvEAJ</a>
CE EC-Declaration for Industrial/Commercial/ITE	<a href="http://globtek.force.com/models/ec_declaration?id=a0Oa000000MmbDvEAJ">http://globtek.force.com/models/ec_declaration?id=a0Oa000000MmbDvEAJ</a>
CE EC-Declaration for Household	<a href="http://globtek.force.com/models/ec_declaration?id=a0Oa000000MmbDvEAJ">http://globtek.force.com/models/ec_declaration?id=a0Oa000000MmbDvEAJ</a>
RoHS/RoHS3 Declaration	<a href="https://www.globtek.com/pdf/rohs_cert/01ta0000007dIB5AAM">https://www.globtek.com/pdf/rohs_cert/01ta0000007dIB5AAM</a>
REACH Declaration	<a href="https://www.globtek.com/pdf/iso_certificates/REACH.pdf">https://www.globtek.com/pdf/iso_certificates/REACH.pdf</a>
Conflict Minerals Declaration	<a href="https://www.globtek.com/pdf/conflict-minerals.pdf">https://www.globtek.com/pdf/conflict-minerals.pdf</a>
IPXY rating is based on 3rd party testing and customers should check suitability and test system level IPXY rating before ordering.	
<b>Regulatory Certifications/Label Markings</b>	
LATEST PRODUCT/MODEL CERTIFICATIONS: <a href="http://en.globtek.com/datasheet/id/a0Oa000000MmbDv">http://en.globtek.com/datasheet/id/a0Oa000000MmbDv</a>	
AGENCY ONLINE DOCUMENTS:	<a href="http://www.globtek.info/certs/GTM96180-TZ/">http://www.globtek.info/certs/GTM96180-TZ/</a>
	(E1) Earthed output
	Center Positive (+V)

GlobTek, Inc. www.globtek.com 186 Veterans Drive, Northvale, NJ 07647 Tel. (201) 784-1000 Fax (201) 784-0111	Drawing Title: GTM96180-1830-12.0-T3, ITE / Medical Power Supply/Class 2/Household Power Supply, Efficiency Level: VI, Case Color/Style: GlobTek Black, Desktop/External, Regulated Switchmode AC-DC Power Supply AC Adaptor, Input Rating: 100-240V~, 50-60 Hz, IEC 60320/C14 , Output Rating: 18W, 18V@1A, Output Configuration: 1500 mm, 18/1C + Shield Cond, UL 1185, Female Barrel 5.5 * 2.5 * 11mm with internal Spring Clip and Locking Notch or Equal, Ferrite: None, GlobTek Black, GT Cord # C5101, Pin Out: Center Positive (+V), Blades/Input Cord: (Order Separately), Approvals: Taiwan BSMI; IP42; RCM; CB 60601-1; cETLus 60601-1 3rd; cETLus; CAN ICES-3; FCC; PSE; PSE; WEEE; VCCI; Ukraine; RoHS; LPS; Level VI; China RoHS; CE; Fuse 60335; CB 62368; CB 60950; Class I; 230V CoC Tier 2; cULus; Korea (12V Only); EAC; NOM; S-Mark 60950;ETL; CCC; CE; IRAM; CB 60335; cETLus UL1310; Fuse 60335;	
	Model No. GTM96180-1830-12.0-T3	
	Part No./Ordering No. TR9CH1000LCP-IM-R6B	Rev B

## PACKAGING

Packing Spec P/N: Standard DT, Individually Box, GT User Manual  
Box Qty: 60  
Gift Box Size (mm): 147\*100\*33  
Gift Box Color: White  
Master Carton Size (mm): 455 x 405 x 220  
Master Carton Cubic Volume (m<sup>3</sup>): 0.04  
Master GW (Kg): 13.2 kg  
BLADES INCLUDED: None:  
BLADE/CORD INSTALLED: None:  
USER MANUAL: 809-DESKTOPUSERMANUAL on A4 paper  
USER MANUAL WEB LINK: <https://en.globtek.com/pdf/809-DESKTOPUSERMANUA...>

### PROPRIETARY INFORMATION

GlobTek, Inc. www.globtek.com 186 Veterans Drive, Northvale, NJ 07647 Tel. (201) 784-1000 Fax (201) 784-0111	Drawing Title: GTM96180-1830-12.0-T3, ITE / Medical Power Supply/Class 2/Household Power Supply, Efficiency Level: VI, Case Color/Style: GlobTek Black, Desktop/External, Regulated Switchmode AC-DC Power Supply AC Adaptor, Input Rating: 100-240V~, 50-60 Hz, IEC 60320/C14 , Output Rating: 18W, 18V@1A, Output Configuration: 1500 mm, 18/1C + Shield Cond, UL 1185, Female Barrel 5.5 * 2.5 * 11mm with internal Spring Clip and Locking Notch or Equal, Ferrite: None, GlobTek Black, GT Cord # C5101, Pin Out: Center Positive (+V), Blades/Input Cord: (Order Separately), Approvals: Taiwan BSMI; IP42; RCM; CB 60601-1; cETLus 60601-1 3rd; cETLus; CAN ICES-3; FCC; PSE; PSE; WEEE; VCCI; Ukraine; RoHS; LPS; Level VI; China RoHS; CE; Fuse 60335; CB 62368; CB 60950; Class I; 230V CoC Tier 2; cULus; Korea (12V Only); EAC; NOM; S-Mark 60950; ETL; CCC; CE; IRAM; CB 60335; cETLus UL1310; Fuse 60335;	
	Model No. GTM96180-1830-12.0-T3	
	Part No./Ordering No. TR9CH1000LCP-IM-R6B	Rev B

If specific packaging is required, this section must specify all requirements and note "no exceptions". If this section does not specify packaging, it is subject to change without notice at GlobTek's discretion

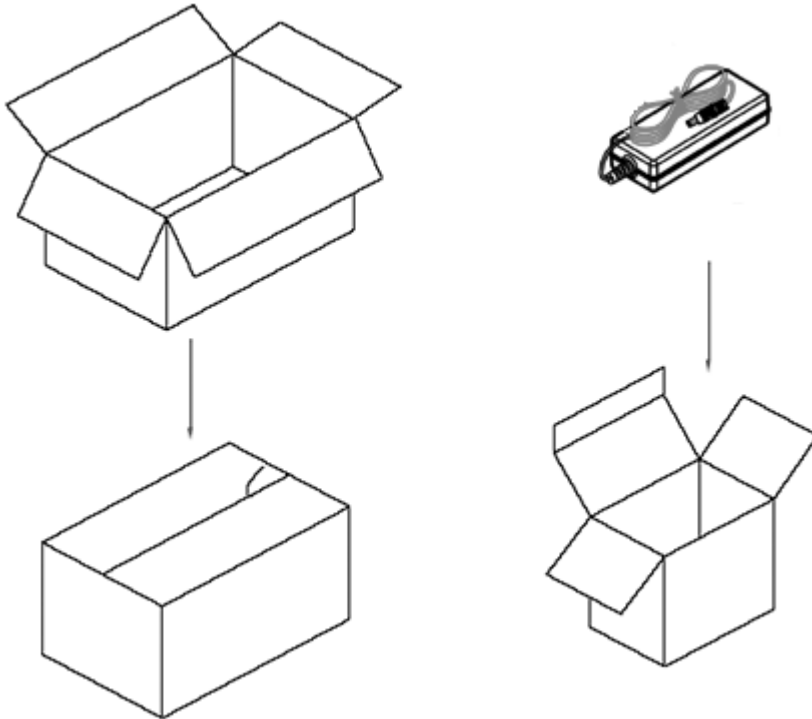

GlobTek, Inc. www.globtek.com 186 Veterans Drive, Northvale, NJ 07647 Tel. (201) 784-1000 Fax (201) 784-0111	Drawing Title: GTM96180-1830-12.0-T3, ITE / Medical Power Supply/Class 2/Household Power Supply, Efficiency Level: VI, Case Color/Style: GlobTek Black, Desktop/External, Regulated Switchmode AC-DC Power Supply AC Adaptor, Input Rating: 100-240V~, 50-60 Hz, IEC 60320/C14 , Output Rating: 18W, 18V@1A, Output Configuration: 1500 mm, 18/1C + Shield Cond, UL 1185, Female Barrel 5.5 * 2.5 * 11mm with internal Spring Clip and Locking Notch or Equal, Ferrite: None, GlobTek Black, GT Cord # C5101, Pin Out: Center Positive (+V), Blades/Input Cord: (Order Separately), Approvals: Taiwan BSMI; IP42; RCM; CB 60601-1; cETLus 60601-1 3rd; cETLus; CAN ICES-3; FCC; PSE; PSE; WEEE; VCCI; Ukraine; RoHS; LPS; Level VI; China RoHS; CE; Fuse 60335; CB 62368; CB 60950; Class I; 230V CoC Tier 2; cULus; Korea (12V Only); EAC; NOM; S-Mark 60950;ETL; CCC; CE; IRAM; CB 60335; cETLus UL1310; Fuse 60335;	
	Model No. GTM96180-1830-12.0-T3	
	Part No./Ordering No. TR9CH1000LCP-IM-R6B	Rev B

## INSTRUCTIONS TO THE OEM SYSTEMS ENGINEER

It is the responsibility of the OEM systems engineer to provide the end system user instructions and warnings for the use of this product in the end system.

If an input cord is required for this product, AC Mains voltage should be provided to the power supply by a power supply cord approved to the national standards of the country in which it will be used.

This power supply is not designed to be repaired. No serviceable parts inside. A blown internal fuse is an indication of catastrophic failure of circuit component(s). If a Failure Analysis is required for a failed power supply/battery charger, please return the damaged unit to Globtek for an accurate determination of the root cause of the failure.

EMC Compliance of the complete OEM product, including the GlobTek power supply/battery charger needs to be verified by the OEM systems engineer.

## INSTRUCTION SHEET

N/A