

| | | |
|--|--|--------|
| GloTek, Inc. www.globtek.com 186 Veterans Drive, Northvale, NJ 07647 Tel. (201) 784-1000 Fax (201) 784-0111 | Drawing Title: GT-46600-6015-T3, ICT/ITE Power Supply, Efficiency Level: USA DOE Level VI / Eco-design Directive 2009/125/EC, (EU) 2019/1782, Case Color/Style: GlobTek Black, Desktop/External, Regulated Switchmode AC-DC Power Supply AC Adaptor, Input Rating: 100-240V~, 50-60 Hz, IEC 60320/C14 , Output Rating: 60W, 15.0V@4.0A, Output Configuration: 1200 mm, 16/2 Cond, UL 2468, Female Barrel 5.5*2.1*11mm WITH internal Spring Clip and Locking Notch or Equal, Ferrite: Core Size: RH 14.2*28.5*10, GlobTek Black, GT Cord # C40075, Pin Out: Center Positive (+V), Blades/Input Cord: Not Applicable, Approvals: NOM (12V and 15V); South Africa; 230V CoC Tier 2; Saudi; Malaysia; Singapore (12V); Taiwan BSMI (12V and 15V); CB 60335; EAC; BIS; South Africa; CB 60950; UKCA; cULus; NOM (24V only) (pending); NrCAN (12V and 15V); Morocco; CB 62368; FCC; IRAM; CE; CE; China RoHS; Class I; Level VI; LPS 60950; RoHS; Ukraine; VCCI; WEEE; cULus; PSE; PSE; CAN ICES-3; CCC; Korea (12V, 15V Only); GEMS (12V); RCM; | |
| | Model No. GT-46600-6015-T3 | |
| | Part No./Ordering No. TR9CG4000CCP-N(R6B) | Rev B1 |

REVISION HISTORY

| REV | DESCRIPTION | SUB | DATE | APPROVED |
|-----|--|-----|------------|----------|
| B1 | Add NRCAN to approvals | | 02/26/2020 | QA |
| B | Update CCC, add EAC, Saudi Arabia, BSMI, BIS | | 05/10/2019 | QA |
| A1 | Remove QPS and update Ukraine No | | 10/25/2017 | QA |
| A | Initial Release | | 05/02/2017 | QA |

In Addition to GlobTek Inc.'s renewed ISO9001:2015 - Quality Management System Certification, GlobTek Inc. is now certified to:

ISO13485:2016 - Medical Devices Quality Management System Certification

ISO14001:2015 - Environmental Management System Certification

ISO Certificates are available online at <https://www.globtek.com/iso-certificates/>

Customer Approval of Specification:

Please approve, sign and send back to GlobTek so we can complete order processing.

A delay in receipt of this form will delay delivery schedule.

Company Name:

Customer P/N:

Quote Number:

Date:

Authorized Representative Name:

Authorized Representative Signature:

The acceptance of this specification and use of the product described in this document indicates the acceptance and binding of the customer to Globtek terms and conditions, which supersede all other agreements, terms, and conditions (<https://en.globtek.com/terms-and-conditions/>).

The purchaser of this product (Customer) agrees that it is their sole responsibility to determine suitability/fitness of the product described in this specification for their application and to take precautions for protection against any hazards attendant to the handling and use of the product.

Footnote:

GlobTek Inc. will not be liable for the safety and performance of these power supplies if unauthorized access and repair occurs. End user should consult applicable UL, CSA or EN standards for proper installation instruction.

Limitation of Use:

GlobTek products are intended for use with commercial, medical, and/or industrial equipment only. GlobTek product are not authorized for use as mission critical components in life support hazardous environment, nuclear or aircraft applications without prior written approval from the CEO of GlobTek Inc.

Contents of this document are subject to change without prior notice.

| | | |
|--|--|--------|
| GlobTek, Inc. www.globtek.com 186 Veterans Drive, Northvale, NJ 07647 Tel. (201) 784-1000 Fax (201) 784-0111 | Drawing Title: GT-46600-6015-T3, ICT/ITE Power Supply, Efficiency Level: USA DOE Level VI / Eco-design Directive 2009/125/EC, (EU) 2019/1782, Case Color/Style: GlobTek Black, Desktop/External, Regulated Switchmode AC-DC Power Supply AC Adaptor, Input Rating: 100-240V~, 50-60 Hz, IEC 60320/C14 , Output Rating: 60W, 15.0V@4.0A, Output Configuration: 1200 mm, 16/2 Cond, UL 2468, Female Barrel 5.5*2.1*11mm WITH internal Spring Clip and Locking Notch or Equal, Ferrite: Core Size: RH 14.2*28.5*10, GlobTek Black, GT Cord # C40075, Pin Out: Center Positive (+V), Blades/Input Cord: Not Applicable, Approvals: NOM (12V and 15V); South Africa; 230V CoC Tier 2; Saudi; Malaysia; Singapore (12V); Taiwan BSMI (12V and 15V); CB 60335; EAC; BIS; South Africa; CB 60950; UKCA: cULus; NOM (24V only) (pending); NrCAN (12V and 15V); Morocco; CB 62368; FCC; IRAM; CE; CE; China RoHS; Class I; Level VI; LPS 60950; RoHS; Ukraine; VCCI; WEEE; cULus; PSE; PSE; CAN ICES-3; CCC; Korea (12V, 15V Only); GEMS (12V); RCM; | |
| | Model No. GT-46600-6015-T3 | |
| | Part No./Ordering No. TR9CG4000CCP-N(R6B) | Rev B1 |

POWER SUPPLY INFORMATION

| | |
|---------------------------------|--|
| TYPE: | Desktop/External |
| TECHNOLOGY: | Regulated Switchmode AC-DC Power Supply AC Adaptor |
| CASE COLOR: | GlobTek Black |
| NAMEPLATE RATED INPUT: | 100-240V~, 50-60 Hz, 1.5A |
| INPUT CONFIG: | IEC 60320/C14 |
| WATTS: | 60.0 |
| VOLTS OUT: | 15.0 |
| CURRENT OUT (Amps): | 4.0 |
| BLADE/CORD INCLUDED: | N/A Not Applicable |
| BLADE/CORD INSTALLED: | N/A :Not Applicable |
| INGRESS PROTECTION: | IPX0 |
| GROUNDING CONFIGURATION: | (E1) Earthed output |
| EFFICIENCY LEVEL: | USA DOE Level VI / Eco-design Directive 2009/125/EC, (EU) 2019/1782 |
| OUTPUT CONFIGURATION: | 1200 mm, 16/2 Cond, UL 2468, Female Barrel 5.5*2.1*11mm WITH internal Spring Clip and Locking Notch or Equal, Ferrite: Core Size: RH 14.2*28.5*10, GlobTek Black, GT Cord # C40075 |
| OVERMOLDED: | Yes |
| CONNECTOR PIN OUT: | Center Positive (+V) |
| LABEL SPECS: | Standard GT,L-1186 |
| SPECIAL BARCODE LABEL MATERIAL: | No |
| PACK SPEC: | PACKING FOR GT-46600, User manual |
| USER MANUAL: | 809-DESKTOPUSERMANUAL on A4 paper |

| | |
|--|---|
| <p>GlobTek, Inc. www.globtek.com 186 Veterans Drive, Northvale, NJ 07647 Tel. (201) 784-1000 Fax (201) 784-0111</p> | <p>Drawing Title: GT-46600-6015-T3, ICT/ITE Power Supply, Efficiency Level: USA DOE Level VI / Eco-design Directive 2009/125/EC, (EU) 2019/1782, Case Color/Style: GlobTek Black, Desktop/External, Regulated Switchmode AC-DC Power Supply AC Adaptor, Input Rating: 100-240V~, 50-60 Hz, IEC 60320/C14 , Output Rating: 60W, 15.0V@4.0A, Output Configuration: 1200 mm, 16/2 Cond, UL 2468, Female Barrel 5.5*2.1*11mm WITH internal Spring Clip and Locking Notch or Equal, Ferrite: Core Size: RH 14.2*28.5*10, GlobTek Black, GT Cord # C40075, Pin Out: Center Positive (+V), Blades/Input Cord: Not Applicable, Approvals: NOM (12V and 15V); South Africa; 230V CoC Tier 2; Saudi; Malaysia; Singapore (12V); Taiwan BSMI (12V and 15V); CB 60335; EAC; BIS; South Africa; CB 60950; UKCA; cULus; NOM (24V only) (pending); NrCAN (12V and 15V); Morocco; CB 62368; FCC; IRAM; CE; CE; China RoHS; Class I; Level VI; LPS 60950; RoHS; Ukraine; VCCE; WEEE; cULus; PSE; PSE; CAN ICES-3; CCC; Korea (12V, 15V Only); GEMS (12V); RCM;</p> |
| | <p>Model No. GT-46600-6015-T3</p> |
| | <p>Part No./Ordering No. TR9CG4000CCP-N(R6B) Rev B1</p> |

Notes/Modifications/Customizations (notes in this section supersede the values shown in the standard spec):
DIMENSIONS ARE IN MM UNLESS SPECIFIED OTHERWISE.

| | | |
|---|--|--------|
| GloBtek, Inc. www.globtek.com 186 Veterans Drive, Northvale, NJ 07647 Tel. (201) 784-1000 Fax (201) 784-0111 | Drawing Title: GT-46600-6015-T3, ICT/ITE Power Supply, Efficiency Level: USA DOE Level VI / Eco-design Directive 2009/125/EC, (EU) 2019/1782, Case Color/Style: GlobTek Black, Desktop/External, Regulated Switchmode AC-DC Power Supply AC Adaptor, Input Rating: 100-240V~, 50-60 Hz, IEC 60320/C14 , Output Rating: 60W, 15.0V@4.0A, Output Configuration: 1200 mm, 16/2 Cond, UL 2468, Female Barrel 5.5*2.1*11mm WITH internal Spring Clip and Locking Notch or Equal, Ferrite: Core Size: RH 14.2*28.5*10, GlobTek Black, GT Cord # C40075, Pin Out: Center Positive (+V), Blades/Input Cord: Not Applicable, Approvals: NOM (12V and 15V); South Africa; 230V CoC Tier 2; Saudi; Malaysia; Singapore (12V); Taiwan BSMI (12V and 15V); CB 60335; EAC; BIS; South Africa; CB 60950; UKCA: cULus; NOM (24V only) (pending); NrCAN (12V and 15V); Morocco; CB 62368; FCC; IRAM; CE; CE; China RoHS; Class I; Level VI; LPS 60950; RoHS; Ukraine; VCCI; WEEE; cULus; PSE; PSE; CAN ICES-3; CCC; Korea (12V, 15V Only); GEMS (12V); RCM; | |
| | Model No. GT-46600-6015-T3 | |
| | Part No./Ordering No. TR9CG4000CCP-N(R6B) | Rev B1 |

ELECTRICAL SPECIFICATIONS

A) ELECTRICAL SPECIFICATIONS:

01. Input Voltage: Specified 90-264 Vac, Nameplate rated: 100-240Vac
02. Input Frequency: Specified 47-63 Hz, Nameplate rated 50-60Hz
03. Input Rated Current: 1.5A RMS Max
04. Inrush Current: No damage at 240VAC Cold Start
05. Average Efficiency: 88% Min (CEC & DOE LEVEL VI Compliant); 89% Min (ErP Tier2 Compliant)
06. Input Power(no load): <0.21W (CEC &DOE Level VI Compliant); <0.15W (ErP Tier2 Compliant)
07. Output Regulation: +/- 5% measured at the output connector
08. Line regulation: ±1%
09. Ripple Voltage: 200mV (p-p) (100-240V AC Input). Measuring is done by 20MHz bandwidth oscilloscope and terminated each output with a 10uf aluminum electrolytic capacitor and 0.1uf ceramic capacitor.

B) PROTECTION

01. Over-Voltage: Electronically Protected Zener clamp across the output
02. Short Circuit: Electronically Protected unit will auto recover upon removal of fault
03. Over Temperature Protection: There shall be no ignition or smoke and deformation of case
04. Over voltage protection: for 12V - 16V; for 15V - 20.25V, for 19V - 25.65, for 24V - 32.4V

C) SAFETY

01. Dielectric Withstand Voltage: 4242Vdc from primary to secondary
02. Earth Leakage Current: <3.5 mA at 240Vac input voltage
03. Touch Current: <0.25mA @ 240Vac input voltage
04. ROHS 2: Complies with EU 2011/65/EU and China SJ/T 11363-2006
05. Earth continuity test:<0.1 Ohm or < 0.2 Ohm when with a non-detachable Power Supply cord, Class I Only

D) OTHER:

01. MTBF: 1,500,000 hours @ 25°C ambient, full load (Telcordia SR-332, Issue 3)
02. Operating Temperature: 0°C to 40°C ambient temperature
03. Humidity: 10% to 90% relative humidity
04. Storage Temperature: -10°C to 70°C
05. Cooling: Convection
06. ROHS 2: Complies with EU 2011/65/EU and China SJ/T 11363-2006

E) ENCLOSURE

01. Housing: High impact plastic, 94V0 polycarbonate, non-vented
02. Size: 121*52*33 +/-1.0 mm
03. Markings: Label and/or Pad Printed and/or Molded in the case

TO ADDRESS SYSTEM-LEVEL EMI CONCERNS, FERRITE CHOKES/BEADS MAY BE ADDED/REVISED UPON REQUEST. A SAMPLE KIT OF GLOBTEK'S STANDARD FERRITES IS AVAILABLE UNDER GLOBTEK P/N: EMI-MITIGATION-KIT1

FOR ADDITIONAL INFORMATION, PLEASE READ OUR WHITE PAPER AT:

<https://en.globtek.com/technical-articles/ferrite-kit-radiated-emi-suppression-kit-for-globtek-power-supplies-cable-assemblies>

PROPRIETARY INFORMATION

PROPRIETARY OF GLOBTEK, INC. ANY REPRODUCTION, DISCLOSURE OR USE OF THIS DRAWING, IN WHOLE OR IN PART, IS HEREBY PROHIBITED EXCEPT AS SPECIFIED IN WRITING BY GLOBTEK, INC. © GlobTek, Inc. 2017 - 2021

quest/06/14/2021 12:32:35 AM

| | |
|--|---|
| <p>GlobTek, Inc. www.globtek.com 186 Veterans Drive, Northvale, NJ 07647 Tel. (201) 784-1000 Fax (201) 784-0111</p> | <p>Drawing Title: GT-46600-6015-T3, ICT/ITE Power Supply, Efficiency Level: USA DOE Level VI / Eco-design Directive 2009/125/EC, (EU) 2019/1782, Case Color/Style: GlobTek Black, Desktop/External, Regulated Switchmode AC-DC Power Supply AC Adaptor, Input Rating: 100-240V~, 50-60 Hz, IEC 60320/C14 , Output Rating: 60W, 15.0V@4.0A, Output Configuration: 1200 mm, 16/2 Cond, UL 2468, Female Barrel 5.5*2.1*11mm WITH internal Spring Clip and Locking Notch or Equal, Ferrite: Core Size: RH 14.2*28.5*10, GlobTek Black, GT Cord # C40075, Pin Out: Center Positive (+V), Blades/Input Cord: Not Applicable, Approvals: NOM (12V and 15V); South Africa; 230V CoC Tier 2; Saudi; Malaysia; Singapore (12V); Taiwan BSMI (12V and 15V); CB 60335; EAC; BIS; South Africa; CB 60950; UKCA; cULus; NOM (24V only) (pending); NrCAN (12V and 15V); Morocco; CB 62368; FCC; IRAM; CE; CE; China RoHS; Class I; Level VI; LPS 60950; RoHS; Ukraine; VCCE; WEEE; cULus; PSE; PSE; CAN ICES-3; CCC; Korea (12V, 15V Only); GEMS (12V); RCM;</p> |
| | <p>Model No. GT-46600-6015-T3</p> |
| | <p>Part No./Ordering No. TR9CG4000CCP-N(R6B) Rev B1</p> |

INGRESS PROTECTION: IPX0

GlobTek, Inc.
 www.globtek.com
 186 Veterans Drive,
 Northvale, NJ 07647
 Tel. (201) 784-1000
 Fax (201) 784-0111

Drawing Title: GT-46600-6015-T3, ICT/ITE Power Supply, Efficiency Level: USA DOE Level VI / Eco-design Directive 2009/125/EC, (EU) 2019/1782, Case Color/Style: GlobTek Black, Desktop/External, Regulated Switchmode AC-DC Power Supply AC Adaptor, Input Rating: 100-240V~, 50-60 Hz, IEC 60320/C14 , Output Rating: 60W, 15.0V@4.0A, Output Configuration: 1200 mm, 16/2 Cond, UL 2468, Female Barrel 5.5*2.1*11mm WITH internal Spring Clip and Locking Notch or Equal, Ferrite: Core Size: RH 14.2*28.5*10, GlobTek Black, GT Cord # C40075, Pin Out: Center Positive (+V), Blades/Input Cord: Not Applicable, Approvals: NOM (12V and 15V); South Africa; 230V CoC Tier 2; Saudi; Malaysia; Singapore (12V); Taiwan BSMI (12V and 15V); CB 60335; EAC; BIS; South Africa; CB 60950; UKCA; cULus; NOM (24V only) (pending); NrCAN (12V and 15V); Morocco; CB 62368; FCC; IRAM; CE; CE; China RoHS; Class I; Level VI; LPS 60950; RoHS; Ukraine; VCCL; WEEE; cULus; PSE; PSE; CAN ICES-3; CCC; Korea (12V, 15V Only); GEMS (12V); RCM;

Model No. GT-46600-6015-T3

Part No./Ordering No. TR9CG4000CCP-N(R6B)

Rev B1

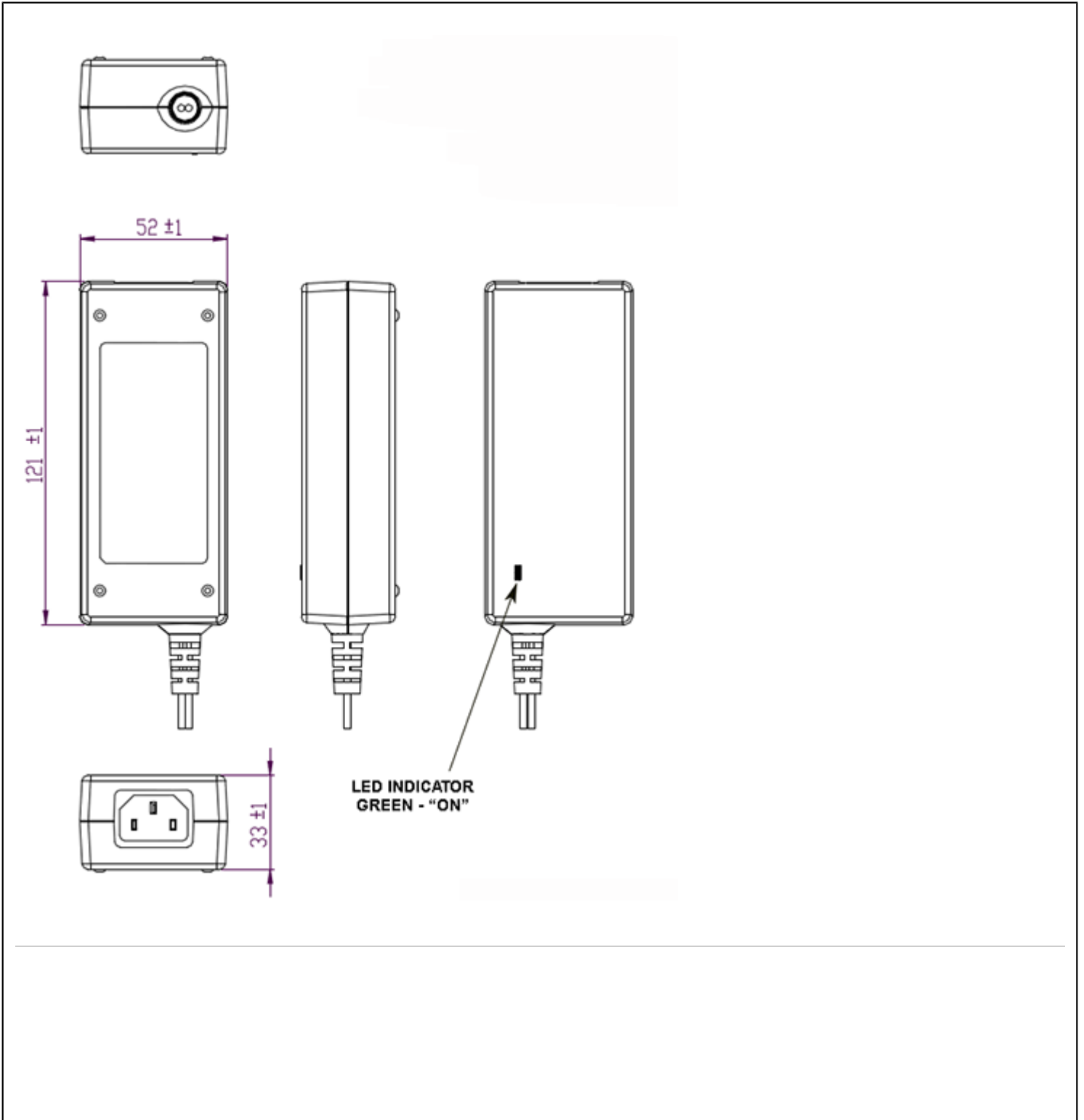

PROPRIETARY INFORMATION

PROPRIETARY OF GLOBTEK, INC. ANY REPRODUCTION, DISCLOSURE OR USE OF THIS DRAWING, IN WHOLE OR IN PART, IS HEREBY PROHIBITED EXCEPT AS SPECIFIED IN WRITING BY GLOBTEK, INC. © GlobTek, Inc. 2017 - 2021

GlobTek, Inc.
 www.globtek.com
 186 Veterans Drive,
 Northvale, NJ 07647
 Tel. (201) 784-1000
 Fax (201) 784-0111

Drawing Title: GT-46600-6015-T3, ICT/ITE Power Supply, Efficiency Level: USA DOE Level VI / Eco-design Directive 2009/125/EC, (EU) 2019/1782, Case Color/Style: GlobTek Black, Desktop/External, Regulated Switchmode AC-DC Power Supply AC Adaptor, Input Rating: 100-240V~, 50-60 Hz, IEC 60320/C14 , Output Rating: 60W, 15.0V@4.0A, Output Configuration: 1200 mm, 16/2 Cond, UL 2468, Female Barrel 5.5*2.1*11mm WITH internal Spring Clip and Locking Notch or Equal, Ferrite: Core Size: RH 14.2*28.5*10, GlobTek Black, GT Cord # C40075, Pin Out: Center Positive (+V), Blades/Input Cord: Not Applicable, Approvals: NOM (12V and 15V); South Africa; 230V CoC Tier 2; Saudi; Malaysia; Singapore (12V); Taiwan BSMI (12V and 15V); CB 60335; EAC; BIS; South Africa; CB 60950; UKCA; cULus; NOM (24V only) (pending); NrCAN (12V and 15V); Morocco; CB 62368; FCC; IRAM; CE; CE; China RoHS; Class I; Level VI; LPS 60950; RoHS; Ukraine; VCCI; WEEE; cULus; PSE; PSE; CAN ICES-3; CCC; Korea (12V, 15V Only); GEMS (12V); RCM;

Model No. GT-46600-6015-T3

Part No./Ordering No. TR9CG4000CCP-N(R6B)

Rev B1

DERATING CURVE

Typical External Power Supply Derating Curve

(For Efficiency Level V and Efficiency Level VI Products)

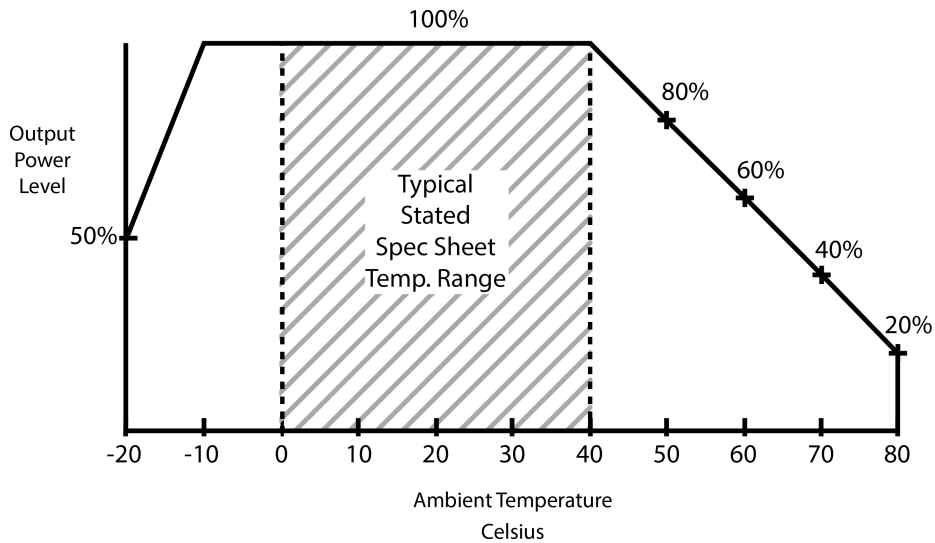

| | | |
|---|--|--------|
| GloBtek, Inc. www.globtek.com 186 Veterans Drive, Northvale, NJ 07647 Tel. (201) 784-1000 Fax (201) 784-0111 | Drawing Title: GT-46600-6015-T3, ICT/ITE Power Supply, Efficiency Level: USA DOE Level VI / Eco-design Directive 2009/125/EC, (EU) 2019/1782, Case Color/Style: GlobTek Black, Desktop/External, Regulated Switchmode AC-DC Power Supply AC Adaptor, Input Rating: 100-240V~, 50-60 Hz, IEC 60320/C14 , Output Rating: 60W, 15.0V@4.0A, Output Configuration: 1200 mm, 16/2 Cond, UL 2468, Female Barrel 5.5*2.1*11mm WITH internal Spring Clip and Locking Notch or Equal, Ferrite: Core Size: RH 14.2*28.5*10, GlobTek Black, GT Cord # C40075, Pin Out: Center Positive (+V), Blades/Input Cord: Not Applicable, Approvals: NOM (12V and 15V); South Africa; 230V CoC Tier 2; Saudi; Malaysia; Singapore (12V); Taiwan BSMI (12V and 15V); CB 60335; EAC; BIS; South Africa; CB 60950; UKCA: cULus; NOM (24V only) (pending); NrCAN (12V and 15V); Morocco; CB 62368; FCC; IRAM; CE; CE; China RoHS; Class I; Level VI; LPS 60950; RoHS; Ukraine; VCCI; WEEE; cULus; PSE; PSE; CAN ICES-3; CCC; Korea (12V, 15V Only); GEMS (12V); RCM; | |
| | Model No. GT-46600-6015-T3 | |
| | Part No./Ordering No. TR9CG4000CCP-N(R6B) | Rev B1 |

INPUT CONFIGURATION

(E1) Earthed output

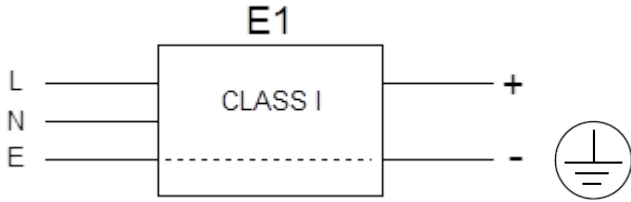

[Alternate grounding configurations](#) available upon request.

Blades/Cord Included:N/A:Not Applicable

Blades/Cord Installed:N/A:Not Applicable

IEC 60320/C14 AC Inlet Connector, Class I, Earth Ground

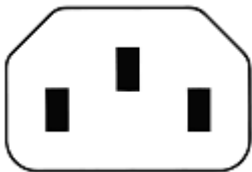

Mates with IEC 60320/C13 Plug

Optional Locking IEC60320 Receptacle and cord option available on some models by request.:



[Standard International IEC 320/C13 Cordsets](#)

Below are standard cordsets which are "not included" (unless stated above); these can be purchased separately or packaged with the power supply. Contact your Sales Engineer if the style required is not shown below. Many more available in different lengths, colors or cable material.

Stock Power Supply Cords

| Part Number/ Link | Country | Plug | Termination | Length (mm) | (Ft) |
|--------------------------------|----------------------|------------|-------------|-------------|------|
| 3021457F701(R) | N. American (Type B) | NEMA 5-15P | IEC 320/C13 | 2150 | 7 |

PROPRIETARY INFORMATION

PROPRIETARY OF GLOBTEK, INC. ANY REPRODUCTION, DISCLOSURE OR USE OF THIS DRAWING, IN WHOLE OR IN PART, IS HEREBY PROHIBITED EXCEPT AS SPECIFIED IN WRITING BY GLOBTEK, INC. © GlobTek, Inc. 2017 - 2021

| | | |
|--|--|--------|
| GloTek, Inc. www.globtek.com 186 Veterans Drive, Northvale, NJ 07647 Tel. (201) 784-1000 Fax (201) 784-0111 | Drawing Title: GT-46600-6015-T3, ICT/ITE Power Supply, Efficiency Level: USA DOE Level VI / Eco-design Directive 2009/125/EC, (EU) 2019/1782, Case Color/Style: GlobTek Black, Desktop/External, Regulated Switchmode AC-DC Power Supply AC Adaptor, Input Rating: 100-240V~, 50-60 Hz, IEC 60320/C14 , Output Rating: 60W, 15.0V@4.0A, Output Configuration: 1200 mm, 16/2 Cond, UL 2468, Female Barrel 5.5*2.1*11mm WITH internal Spring Clip and Locking Notch or Equal, Ferrite: Core Size: RH 14.2*28.5*10, GlobTek Black, GT Cord # C40075, Pin Out: Center Positive (+V), Blades/Input Cord: Not Applicable, Approvals: NOM (12V and 15V); South Africa; 230V CoC Tier 2; Saudi; Malaysia; Singapore (12V); Taiwan BSMI (12V and 15V); CB 60335; EAC; BIS; South Africa; CB 60950; UKCA: cULus; NOM (24V only) (pending); NrCAN (12V and 15V); Morocco; CB 62368; FCC; IRAM; CE; CE; China RoHS; Class I; Level VI; LPS 60950; RoHS; Ukraine; VCCI; WEEE; cULus; PSE; PSE; CAN ICES-3; CCC; Korea (12V, 15V Only); GEMS (12V); RCM; | |
| | Model No. GT-46600-6015-T3 | |
| | Part No./Ordering No. TR9CG4000CCP-N(R6B) | Rev B1 |

| | | | | | |
|--|--|--|-------------|------|---|
| 1191068F0701(R) | N. American (Type B) | NEMA 5-15P Hospital | IEC 320/C13 | 2459 | 8 |
| 2194272M5701-T(R) | Argentina (Type I) | IRAM 2073 | IEC 320/C13 | 2500 | 8 |
| 5502022M5701A(R) | Australian (Type I) | AS3112 / 3 PRONG | IEC 320/C13 | 2500 | 8 |
| 204B4272M5701(R) | Brazil (Type N) | BRAZIL | IEC 320/C13 | 2500 | 8 |
| 6023602M5701(R) | China (Type I) | CCC GR2099 | IEC 320/C13 | 2500 | 8 |
| G8014272M5701(R) | Danish (Type K) | AFSNIT SECTION 107-2-D1 | IEC 320/C13 | 2500 | 8 |
| 23144272M5701-T(R) | Europe (Type E) | CEE 7/7 | IEC 320/C13 | 2500 | 8 |
| 205IN4272M5701(R) | India (Type D) | India IS 1293 (also known as IA16A3 or BS546) | IEC 320/C13 | 2500 | 8 |
| 208IN4272M5701(R) | India (Type M) | India IS 1293 (also known as IA16A3 or BS546) | IEC320/C13 | 2500 | 8 |
| 377C4272M5701(R) | Israel (Type H) | ISL 377C | IEC 320/C13 | 2500 | 8 |
| 23024272M5701(R) | Italy (Type L) | CEI 23-16/VII | IEC 320/C13 | 2500 | 8 |
| 3003339F701(R) [3x1.25mm2] | Japan (Type B) | JIS 8303 / 3 PINS | IEC 320/C13 | 2500 | 8 |
| 3003068F2701-HK(R) [3 x 2.0mm2] | | | | | |
| 302J115J6F0701J(R) | Japan / North America (Type B – 12A) | JIS 8303 / 3 PINS and NEMA 5-15P (PSE and UL/CUL appr) | IEC 320/C13 | 1830 | 6 |
| 302J104J6F0701J(R) | Japan / North America (Type B – 15A) | JIS 8303 / 3 PINS and NEMA 5-15P (PSE and UL/CUL appr) | IEC 320/C13 | 1830 | 6 |
| 2313K3432M5701(R) | Korea (Type F) | KS C 8305 | IEC 320/C13 | 2500 | 8 |
| 5804272M5701(R) | Russia (Type F) | GOST 7396 | IEC 320/C13 | 2500 | 8 |
| 2084272M5701(R) | South Africa (Type M) | South Africa SABS164-1 (16A type) | IEC 320/C13 | 2500 | 8 |
| 23214272M5701(R) | Switzerland (Type J) | SEV 1011 | IEC 320/C13 | 2500 | 8 |
| 3003322M5701(R) | Taiwan (Type B) | BSMI | IEC 320/C13 | 2500 | 8 |
| PZ0800100-2M5BK13H(R) | UK, Hong Kong, Singapore, Gulf States (Type G) | BS 1363A | IEC 320/C13 | 2500 | 8 |
| 7055002M5701A(R) | International | IEC 320 C14-C13 | IEC 320/C13 | 2500 | 8 |

| | | |
|---|--|--------|
| GloBtek, Inc. www.globtek.com 186 Veterans Drive, Northvale, NJ 07647 Tel. (201) 784-1000 Fax (201) 784-0111 | Drawing Title: GT-46600-6015-T3, ICT/ITE Power Supply, Efficiency Level: USA DOE Level VI / Eco-design Directive 2009/125/EC, (EU) 2019/1782, Case Color/Style: GlobTek Black, Desktop/External, Regulated Switchmode AC-DC Power Supply AC Adaptor, Input Rating: 100-240V~, 50-60 Hz, IEC 60320/C14 , Output Rating: 60W, 15.0V@4.0A, Output Configuration: 1200 mm, 16/2 Cond, UL 2468, Female Barrel 5.5*2.1*11mm WITH internal Spring Clip and Locking Notch or Equal, Ferrite: Core Size: RH 14.2*28.5*10, GlobTek Black, GT Cord # C40075, Pin Out: Center Positive (+V), Blades/Input Cord: Not Applicable, Approvals: NOM (12V and 15V); South Africa: 230V CoC Tier 2; Saudi; Malaysia; Singapore (12V); Taiwan BSMI (12V and 15V); CB 60335; EAC; BIS; South Africa; CB 60950; UKCA: cULus; NOM (24V only) (pending); NrCAN (12V and 15V); Morocco: CB 62368; FCC; IRAM; CE; CE; China RoHS; Class I; Level VI; LPS 60950; RoHS; Ukraine; VCCE; WEEE; cULus; PSE; PSE; CAN ICES-3; CCC; Korea (12V, 15V Only); GEMS (12V); RCM; | |
| | Model No. GT-46600-6015-T3 | |
| | Part No./Ordering No. TR9CG4000CCP-N(R6B) | Rev B1 |

OUTPUT CORD AND CONNECTOR: C1S/C40075

ACTUAL CONNECTORS, OVERMOLDS, FERRITES MAY VARY SLIGHTLY FROM THE PICTURE BELOW

| | |
|---|---|
| CABLE TYPE | UL 2468 |
| CABLE LENGTH (mm) | 1200 |
| CABLE TOLERANCE (mm) | ±100 |
| WIRE GAUGE (AWG) | 16 |
| CONDUCTORS | 2 |
| HANK DIMENSION (mm) | 95 ± 10 |
| CABLE / CONNECTOR OVERMOLD COLOR | GlobTek Black |
| FERRITE TYPE / DIMENSION | Core Size: RH 14.2*28.5*10 |
| FERRITE # OF TURNS (Definition) | 2 Pass thru core (1 turns) |
| FERRITE DIMENSION FROM STRAIN RELIEF | N/A |
| FERRITE DIMENSION FROM PLUG | 150 ± 10 |
| PLUG TYPE | Female Barrel 5.5*2.1*11mm WITH internal Spring Clip and Locking Notch or Equal |
| OUTPUT CONNECTOR GENDER | |
| OVERMOLDED | Yes |
| OVER MOLD ORIENTATION | Straight |
| CONNECTOR PIN OUT: | Center Positive (+V) |
| ADDITIONAL REQUIREMENTS | |

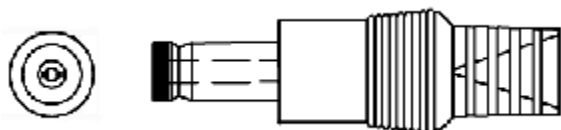

ADDITIONAL OUTPUT PLUG OPTIONS ARE AVAILABLE AT <https://www.globtek.com/connectors/>
STANDARD PLUGS AND CONNECTORS CAN BE SEEN ONLINE AT <https://www.globtek.com/connectors/>
CALCULATE VOLTAGE REGULATION/DROP WITH OUR ONLINE CALCULATOR: <https://en.globtek.com/output-cable-regulation-calculator/>

| | |
|---|---|
| <p>GlobTek, Inc. www.globtek.com 186 Veterans Drive, Northvale, NJ 07647 Tel. (201) 784-1000 Fax (201) 784-0111</p> | <p>Drawing Title: GT-46600-6015-T3, ICT/ITE Power Supply, Efficiency Level: USA DOE Level VI / Eco-design Directive 2009/125/EC, (EU) 2019/1782, Case Color/Style: GlobTek Black, Desktop/External, Regulated Switchmode AC-DC Power Supply AC Adaptor, Input Rating: 100-240V~, 50-60 Hz, IEC 60320/C14 , Output Rating: 60W, 15.0V@4.0A, Output Configuration: 1200 mm, 16/2 Cond, UL 2468, Female Barrel 5.5*2.1*11mm WITH internal Spring Clip and Locking Notch or Equal, Ferrite: Core Size: RH 14.2*28.5*10, GlobTek Black, GT Cord # C40075, Pin Out: Center Positive (+V), Blades/Input Cord: Not Applicable, Approvals: NOM (12V and 15V); South Africa; 230V CoC Tier 2; Saudi; Malaysia; Singapore (12V); Taiwan BSMI (12V and 15V); CB 60335; EAC; BIS; South Africa; CB 60950; UKCA; cULus; NOM (24V only) (pending); NrCAN (12V and 15V); Morocco; CB 62368; FCC; IRAM; CE; CE; China RoHS; Class I; Level VI; LPS 60950; RoHS; Ukraine; VCCI; WEEE; cULus; PSE; PSE; CAN ICES-3; CCC; Korea (12V, 15V Only); GEMS (12V); RCM;</p> |
| | <p>Model No. GT-46600-6015-T3</p> |
| | <p>Part No./Ordering No. TR9CG4000CCP-N(R6B) Rev B1</p> |

OUTPUT CONNECTOR HOOK UP

TO ADDRESS SYSTEM-LEVEL EMI CONCERNS, FERRITE CHOKES/BEADS MAY BE ADDED/REVISED UPON REQUEST. A SAMPLE KIT OF GLOBTEK'S STANDARD FERRITES IS AVAILABLE UNDER GLOBTEK P/N: EMI-MITIGATION-KIT1

FOR ADDITIONAL INFORMATION, PLEASE READ OUR WHITE PAPER AT:

<https://en.globtek.com/technical-articles/ferrite-kit-radiated-emi-suppression-kit-for-globtek-power-supplies-cable-assemblies>

| | | |
|---|--|--------|
| GlobTek, Inc. www.globtek.com 186 Veterans Drive, Northvale, NJ 07647 Tel. (201) 784-1000 Fax (201) 784-0111 | Drawing Title: GT-46600-6015-T3, ICT/ITE Power Supply, Efficiency Level: USA DOE Level VI / Eco-design Directive 2009/125/EC, (EU) 2019/1782, Case Color/Style: GlobTek Black, Desktop/External, Regulated Switchmode AC-DC Power Supply AC Adaptor, Input Rating: 100-240V~, 50-60 Hz, IEC 60320/C14 , Output Rating: 60W, 15.0V@4.0A, Output Configuration: 1200 mm, 16/2 Cond, UL 2468, Female Barrel 5.5*2.1*11mm WITH internal Spring Clip and Locking Notch or Equal, Ferrite: Core Size: RH 14.2*28.5*10, GlobTek Black, GT Cord # C40075, Pin Out: Center Positive (+V), Blades/Input Cord: Not Applicable, Approvals: NOM (12V and 15V); South Africa; 230V CoC Tier 2; Saudi; Malaysia; Singapore (12V); Taiwan BSMI (12V and 15V); CB 60335; EAC; BIS; South Africa; CB 60950; UKCA: cULus; NOM (24V only) (pending); NrCAN (12V and 15V); Morocco; CB 62368; FCC; IRAM; CE; CE; China RoHS; Class I; Level VI; LPS 60950; RoHS; Ukraine; VCCI; WEEE; cULus; PSE; PSE; CAN ICES-3; CCC; Korea (12V, 15V Only); GEMS (12V); RCM; | |
| | Model No. GT-46600-6015-T3 | |
| | Part No./Ordering No. TR9CG4000CCP-N(R6B) | Rev B1 |

LABEL:L-1186

| | |
|---------------------------------|--|
| LABEL P/N: | Standard GT |
| MATERIAL: | Flat Thermal Transfer, Imprintable, Polyester Label and/or Pad Printed and/or Molded, and/or Laser Engraved in the case |
| BACKGROUND COLOR: | Black if housing is Black, White or Silver if housing is White or Gray. |
| TEXT COLOR: | White or Silver if label is Black Background for Black housing. Black if label is White or Silver background and Housing is White or Gray. |
| LABEL WIDTH (mm): | 37.3 |
| LABEL HEIGHT (mm): | 77.3 |
| SPECIAL BARCODE LABEL MATERIAL: | No |

Below is the minimum information which will appear on the label. NOTE: in the logo area additional/actual positioning of symbols and text is subjected to change as per agency updates/requirements or additional model approvals become available.

Regulatory certifications/label markings may be in logo area on the label or molded into the case housing outside the label area.

Information will be shown via label and/or pad printed and/or molded and/or laser engraved in the case. * Date code markings at GlobTek option



XXX = USA or CHINA

DATE CODE A *:

DATE CODE LABEL



Series NO. Week Year
Class NO. for production

or

DATE CODE B *:

WWYY
WW = WEEK
YY = YEAR

A=ICT/ITE Power Supply

B=P/N: (料号) TR9CG4000CCP-N(R6B)

C=Model (型号) GT-46600-6015-T3

D=Input (输入)100-240V~, 50-60 Hz, 1.5A

E=Output (输出)15.0 V $\overline{\text{---}}$ 4.0 A, 60.0W

| | | |
|--|--|--------|
| GlobTek, Inc. www.globtek.com 186 Veterans Drive, Northvale, NJ 07647 Tel. (201) 784-1000 Fax (201) 784-0111 | Drawing Title: GT-46600-6015-T3, ICT/ITE Power Supply, Efficiency Level: USA DOE Level VI / Eco-design Directive 2009/125/EC, (EU) 2019/1782, Case Color/Style: GlobTek Black, Desktop/External, Regulated Switchmode AC-DC Power Supply AC Adaptor, Input Rating: 100-240V~, 50-60 Hz, IEC 60320/C14 , Output Rating: 60W, 15.0V@4.0A, Output Configuration: 1200 mm, 16/2 Cond, UL 2468, Female Barrel 5.5*2.1*11mm WITH internal Spring Clip and Locking Notch or Equal, Ferrite: Core Size: RH 14.2*28.5*10, GlobTek Black, GT Cord # C40075, Pin Out: Center Positive (+V), Blades/Input Cord: Not Applicable, Approvals: NOM (12V and 15V); South Africa; 230V CoC Tier 2; Saudi; Malaysia; Singapore (12V); Taiwan BSMI (12V and 15V); CB 60335; EAC; BIS; South Africa; CB 60950; UKCA; cULus; NOM (24V only) (pending); NrCAN (12V and 15V); Morocco; CB 62368; FCC; IRAM; CE; CE; China RoHS; Class I; Level VI; LPS 60950; RoHS; Ukraine; VCCI; WEEE; cULus; PSE; PSE; CAN ICES-3; CCC; Korea (12V, 15V Only); GEMS (12V); RCM; | |
| | Model No. GT-46600-6015-T3 | |
| | Part No./Ordering No. TR9CG4000CCP-N(R6B) | Rev B1 |

AGENCY ONLINE DOCUMENTS

| |
|--|
| http://www.globtek.info/certs/GT-46600-60VV-X.X/ |
| CE EC-Declaration for Medical Contact GlobTek for more information |
| CE EC-Declaration for Industrial/Commercial/ITE http://globtek.force.com/models/ec_declaration_product?id=01ta0000007dRGO&i=2 |
| CE EC-Declaration for Household Contact GlobTek for more information |
| UKCA-Declaration for Medical Contact GlobTek for more information |
| UKCA-Declaration for Industrial/Commercial/ITE http://globtek.force.com/models/ukca_declaration_product?id=01ta0000007dRGO&i=2 |
| UKCA-Declaration for Household Contact GlobTek for more information |
| Morocco SDoC Declaration https://globtek.secure.force.com/models/Morocco_SDoC_Declaration?id=a00a000000Mia64EAB |
| RoHS/RoHS3 Declaration https://www.globtek.com/pdf/rohs_cert/01ta0000007dRGOAA2 |
| REACH Declaration https://www.globtek.com/pdf/iso_certificates/REACH.pdf |
| Conflict Minerals Declaration https://www.globtek.com/pdf/conflict-minerals.pdf |
| Prop 65 Statement https://en.globtek.com/prop-65-statement.pdf |

IPXY rating is based on 3rd party testing and customers should check suitability and test system level IPXY rating before ordering.

Regulatory Certifications/Label Markings

LATEST PRODUCT/MODEL CERTIFICATIONS: <https://en.globtek.com/datasheet/id/a00a000000Mia64>

AGENCY ONLINE DOCUMENTS: <http://www.globtek.info/certs/GT-46600-60VV-X.X/>



(E1) Earthed output

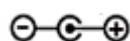

Center Positive (+V)

| | | |
|--|--|--------|
| GlobTek, Inc. www.globtek.com 186 Veterans Drive, Northvale, NJ 07647 Tel. (201) 784-1000 Fax (201) 784-0111 | Drawing Title: GT-46600-6015-T3, ICT/ITE Power Supply, Efficiency Level: USA DOE Level VI / Eco-design Directive 2009/125/EC, (EU) 2019/1782, Case Color/Style: GlobTek Black, Desktop/External, Regulated Switchmode AC-DC Power Supply AC Adaptor, Input Rating: 100-240V~, 50-60 Hz, IEC 60320/C14 , Output Rating: 60W, 15.0V@4.0A, Output Configuration: 1200 mm, 16/2 Cond, UL 2468, Female Barrel 5.5*2.1*11mm WITH internal Spring Clip and Locking Notch or Equal, Ferrite: Core Size: RH 14.2*28.5*10, GlobTek Black, GT Cord # C40075, Pin Out: Center Positive (+V), Blades/Input Cord: Not Applicable, Approvals: NOM (12V and 15V); South Africa; 230V CoC Tier 2; Saudi; Malaysia; Singapore (12V); Taiwan BSMI (12V and 15V); CB 60335; EAC; BIS; South Africa; CB 60950; UKCA; cULus; NOM (24V only) (pending); NrCAN (12V and 15V); Morocco; CB 62368; FCC; IRAM; CE; CE; China RoHS; Class I; Level VI; LPS 60950; RoHS; Ukraine; VCCI; WEEE; cULus; PSE; PSE; CAN ICES-3; CCC; Korea (12V, 15V Only); GEMS (12V); RCM; | |
| | Model No. GT-46600-6015-T3 | |
| | Part No./Ordering No. TR9CG4000CCP-N(R6B) | Rev B1 |

PACKAGING

| | |
|----------------------------------|---|
| Packing Spec P/N: | PACKING FOR GT-46600, User manual |
| Box Qty: | 45 |
| Gift Box Size (mm): | Egg Crate |
| Gift Box Color: | White |
| Master Carton Size (mm): | 520 x 370 x 205 |
| Master Carton Cubic Volume (m³): | 0.04 |
| Master GW (Kg): | 15.6 kg |
| BLADES INCLUDED: | N/A: Not Applicable |
| BLADE/CORD INSTALLED: | N/A: Not Applicable |
| USER MANUAL*: | 809-DESKTOPUSERMANUAL on A4 paper |
| USER MANUAL WEB LINK: | https://en.globtek.com/pdf/809-DESKTOPUSERMANUAL.jpg |

* This specification sheet is considered the user manual for all applications. It is expected that the buyer of this product will use it to formulate their own user manual for their end product and a user manual specifically for the power adapter is not usually required. If a user manual is not specifically listed above then none will be provided with this unit.

| | | |
|--|--|---------------|
| <p>GlobTek, Inc. www.globtek.com 186 Veterans Drive, Northvale, NJ 07647 Tel. (201) 784-1000 Fax (201) 784-0111</p> | <p>Drawing Title: GT-46600-6015-T3, ICT/ITE Power Supply, Efficiency Level: USA DOE Level VI / Eco-design Directive 2009/125/EC, (EU) 2019/1782, Case Color/Style: GlobTek Black, Desktop/External, Regulated Switchmode AC-DC Power Supply AC Adaptor, Input Rating: 100-240V~, 50-60 Hz, IEC 60320/C14 , Output Rating: 60W, 15.0V@4.0A, Output Configuration: 1200 mm, 16/2 Cond, UL 2468, Female Barrel 5.5*2.1*11mm WITH internal Spring Clip and Locking Notch or Equal, Ferrite: Core Size: RH 14.2*28.5*10, GlobTek Black, GT Cord # C40075, Pin Out: Center Positive (+V), Blades/Input Cord: Not Applicable, Approvals: NOM (12V and 15V); South Africa; 230V CoC Tier 2; Saudi; Malaysia; Singapore (12V); Taiwan BSMI (12V and 15V); CB 60335; EAC; BIS; South Africa; CB 60950; UKCA; cULus; NOM (24V only) (pending); NrCAN (12V and 15V); Morocco; CB 62368; FCC; IRAM; CE; CE; China RoHS; Class I; Level VI; LPS 60950; RoHS; Ukraine; VCCI; WEEE; cULus; PSE; PSE; CAN ICES-3; CCC; Korea (12V, 15V Only); GEMS (12V); RCM;</p> <p>Model No. GT-46600-6015-T3</p> <p>Part No./Ordering No. TR9CG4000CCP-N(R6B)</p> | <p>Rev B1</p> |
|--|--|---------------|

If specific packaging is required, this section must specify all requirements and note "no exceptions". If this section does not specify packaging, it is subject to change without notice at GlobTek's discretion

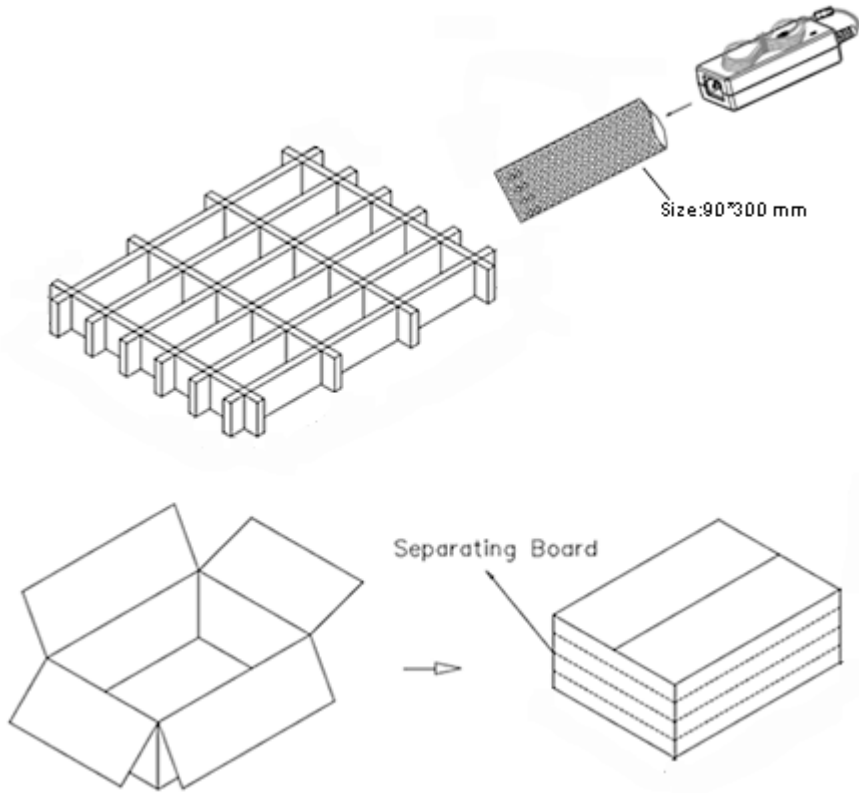

| | | |
|--|--|--------|
| GloTek, Inc. www.globtek.com 186 Veterans Drive, Northvale, NJ 07647 Tel. (201) 784-1000 Fax (201) 784-0111 | Drawing Title: GT-46600-6015-T3, ICT/ITE Power Supply, Efficiency Level: USA DOE Level VI / Eco-design Directive 2009/125/EC, (EU) 2019/1782, Case Color/Style: GlobTek Black, Desktop/External, Regulated Switchmode AC-DC Power Supply AC Adaptor, Input Rating: 100-240V~, 50-60 Hz, IEC 60320/C14 , Output Rating: 60W, 15.0V@4.0A, Output Configuration: 1200 mm, 16/2 Cond, UL 2468, Female Barrel 5.5*2.1*11mm WITH internal Spring Clip and Locking Notch or Equal, Ferrite: Core Size: RH 14.2*28.5*10, GlobTek Black, GT Cord # C40075, Pin Out: Center Positive (+V), Blades/Input Cord: Not Applicable, Approvals: NOM (12V and 15V); South Africa; 230V CoC Tier 2; Saudi; Malaysia; Singapore (12V); Taiwan BSMI (12V and 15V); CB 60335; EAC; BIS; South Africa; CB 60950; UKCA; cULus; NOM (24V only) (pending); NrCAN (12V and 15V); Morocco; CB 62368; FCC; IRAM; CE; CE; China RoHS; Class I; Level VI; LPS 60950; RoHS; Ukraine; VCCI; WEEE; cULus; PSE; PSE; CAN ICES-3; CCC; Korea (12V, 15V Only); GEMS (12V); RCM; | |
| | Model No. GT-46600-6015-T3 | |
| | Part No./Ordering No. TR9CG4000CCP-N(R6B) | Rev B1 |

INSTRUCTIONS TO THE OEM SYSTEMS ENGINEER

It is the responsibility of the OEM systems engineer to provide the end system user instructions and warnings for the use of this product in the end system.

If an input cord is required for this product, AC Mains voltage should be provided to the power supply by a power supply cord approved to the national standards of the country in which it will be used.

This power supply is not designed to be repaired. No serviceable parts inside. A blown internal fuse is an indication of catastrophic failure of circuit component(s). If a Failure Analysis is required for a failed power supply/battery charger, please return the damaged unit to GlobTek for an accurate determination of the root cause of the failure.

EMC Compliance of the complete OEM product, including the GlobTek power supply/battery charger needs to be verified by the OEM systems engineer.

INSTRUCTION SHEET

N/A