

GlobTek, Inc. www.globtek.com 186 Veterans Drive, Northvale, NJ 07647 Tel. (201) 784-1000 Fax (201) 784-0111	Drawing Title: GT-96300-3648-T3-PP, PoE, Passive Power Injector, Efficiency Level: USA DOE Level VI / Eco-design Directive 2009/125/EC, (EU) 2019/1782, Case Color/Style: GlobTek Black, Desktop/External, Single Port Passive Power Over Ethernet Midspan (Passive/Dumb PoE PSE) Power Supply AC Adaptor, Input Rating: 100-240V~, 50-60 Hz, IEC 60320/C14 , Output Rating: 36W, 48.0V@0.75A, Output Configuration: N/A mm, N/A/ Cond, N/A, None, Ferrite: None, N/A, GT Cord # C0745, Pin Out: PoE injector wiring Data, Data+Power, RJ45 x 2, Blades/Input Cord: Not Applicable, Approvals: CB 62368; Patent US9838207B2; EAC; CCC; S-Mark 60950; PSE; PSE; CE; China RoHS; Class I; Level VI; RoHS; Ukraine; VCCI; WEEE; RCM; CB 60335; ETL;	
	Model No. GT-96300-3648-T3-PP	Rev D
Part No./Ordering No. GT-96300-3648-T3-PP		

REVISION HISTORY

REV	DESCRIPTION	SUB	DATE	APPROVED
D	Update grounding configuration from F2 to F3	QA	08/02/2019	QA
C	Update pinout to POE RJ45X2, change packing: master carton dimensions to 442*330*275 mm, gift box dimensions to 125*105*43 mm, Qty to 60pcs/carton	QA	07/25/2019	QA
B	Add EAC, Patent US9838207B2, update RoHS 2 to RoHS, Ukraine mark	QA	08/07/2018	QA
A	Initial Release	jwarn	05/02/2017	QA

In Addition to GlobTek Inc.'s renewed ISO9001:2015 - Quality Management System Certification, GlobTek Inc. is now certified to:

ISO13485:2016 - Medical Devices Quality Management System Certification
ISO14001:2015 - Environmental Management System Certification

ISO Certificates are available online at <https://www.globtek.com/iso-certificates/>

Customer Approval of Specification:

Please approve, sign and send back to GlobTek so we can complete order processing.

A delay in receipt of this form will delay delivery schedule.

Company Name:

Customer P/N:

Quote Number:

Date:

Authorized Representative Name:

Authorized Representative Signature:

The acceptance of this specification and use of the product described in this document indicates the acceptance and binding of the customer to Globtek terms and conditions, which supersede all other agreements, terms, and conditions (<https://en.globtek.com/terms-and-conditions/>).

The purchaser of this product (Customer) agrees that it is their sole responsibility to determine suitability/fitness of the product described in this specification for their application and to take precautions for protection against any hazards attendant to the handling and use of the product.

Footnote:

GlobTek Inc. will not be liable for the safety and performance of these power supplies if unauthorized access and repair occurs. End user should consult applicable UL, CSA or EN standards for proper installation instruction.

Limitation of Use:

GlobTek products are intended for use with commercial, medical, and/or industrial equipment only. GlobTek product are not authorized for use as mission critical components in life support hazardous environment, nuclear or aircraft applications without prior written approval from the CEO of GlobTek Inc.
Contents of this document are subject to change without prior notice.

GlobTek, Inc. www.globtek.com 186 Veterans Drive, Northvale, NJ 07647 Tel. (201) 784-1000 Fax (201) 784-0111	Drawing Title: GT-96300-3648-T3-PP, PoE, Passive Power Injector, Efficiency Level: USA DOE Level VI / Eco-design Directive 2009/125/EC, (EU) 2019/1782, Case Color/Style: GlobTek Black, Desktop/External, Single Port Passive Power Over Ethernet Midspan (Passive/Dumb PoE PSE) Power Supply AC Adaptor, Input Rating: 100-240V~, 50-60 Hz, IEC 60320/C14 , Output Rating: 36W, 48.0V@0.75A, Output Configuration: N/A mm, N/A/ Cond, N/A, None, Ferrite: None, N/A, GT Cord # C0745, Pin Out: PoE injector wiring Data, Data+Power, RJ45 x 2, Blades/Input Cord: Not Applicable, Approvals: CB 62368; Patent US9838207B2; EAC; CCC; S-Mark 60950; PSE; PSE; CE; China RoHS; Class I; Level VI; RoHS; Ukraine; VCCI; WEEE; RCM; CB 60335; ETL;	
	Model No. GT-96300-3648-T3-PP	
	Part No./Ordering No. GT-96300-3648-T3-PP	Rev D

POWER SUPPLY INFORMATION

TYPE:	Desktop/External
TECHNOLOGY:	Single Port Passive Power Over Ethernet Midspan (Passive/Dumb PoE PSE) Power Supply AC Adaptor
CASE COLOR:	GlobTek Black
NAMEPLATE RATED INPUT:	100-240V~, 50-60 Hz, 1.0A
INPUT CONFIG:	IEC 60320/C14
WATTS:	36.0
VOLTS OUT:	48.0
CURRENT OUT (Amps):	0.75
BLADE/CORD INCLUDED:	N/A
BLADE/CORD INSTALLED:	N/A
INGRESS PROTECTION:	IP40
GROUNDING CONFIGURATION:	(F3) Floating output/Isolated Common by Capacitor
EFFICIENCY LEVEL:	
OUTPUT CONFIGURATION:	N/A mm, N/A/ Cond, N/A, None, Ferrite: None, N/A, GT Cord # C0745
CONNECTOR PIN OUT:	PoE injector wiring Data, Data+Power, RJ45 x 2
LABEL SPECS:	Standard GT,L-1186
SPECIAL BARCODE LABEL MATERIAL:	
PACK SPEC:	Standard DT, Individually Box
USER MANUAL:	

PROPRIETARY INFORMATION

PROPRIETARY OF GLOBTEK, INC. ANY REPRODUCTION, DISCLOSURE OR USE OF THIS DRAWING, IN WHOLE OR IN PART, IS HEREBY PROHIBITED EXCEPT AS SPECIFIED IN WRITING BY GLOBTEK, INC. © GlobTek, Inc. 2017 - 2020

<p>GlobTek, Inc. www.globtek.com 186 Veterans Drive, Northvale, NJ 07647 Tel. (201) 784-1000 Fax (201) 784-0111</p>	<p>Drawing Title: GT-96300-3648-T3-PP, PoE, Passive Power Injector, Efficiency Level: USA DOE Level VI / Eco-design Directive 2009/125/EC, (EU) 2019/1782, Case Color/Style: GlobTek Black, Desktop/External, Single Port Passive Power Over Ethernet Midspan (Passive/Dumb PoE PSE) Power Supply AC Adaptor, Input Rating: 100-240V~, 50-60 Hz, IEC 60320/C14 , Output Rating: 36W, 48.0V@0.75A, Output Configuration: N/A mm, N/A/ Cond, N/A, None, Ferrite: None, N/A, GT Cord # C0745, Pin Out: PoE injector wiring Data, Data+Power, RJ45 x 2, Blades/Input Cord: Not Applicable, Approvals: CB 62368; Patent US9838207B2; EAC; CCC; S-Mark 60950; PSE; PSE; CE; China RoHS; Class I; Level VI; RoHS; Ukraine; VCCI; WEEE; RCM; CB 60335; ETL;</p>	
	<p>Model No. GT-96300-3648-T3-PP</p>	
	<p>Part No./Ordering No. GT-96300-3648-T3-PP</p>	<p>Rev D</p>

Notes/Modifications/Customizations (notes in this section supersede the values shown in the standard spec):
DIMENSIONS ARE IN MM UNLESS SPECIFIED OTHERWISE.

<p>GlobTek, Inc. www.globtek.com 186 Veterans Drive, Northvale, NJ 07647 Tel. (201) 784-1000 Fax (201) 784-0111</p>	<p>Drawing Title: GT-96300-3648-T3-PP, PoE, Passive Power Injector, Efficiency Level: USA DOE Level VI / Eco-design Directive 2009/125/EC, (EU) 2019/1782, Case Color/Style: GlobTek Black, Desktop/External, Single Port Passive Power Over Ethernet Midspan (Passive/Dumb PoE PSE) Power Supply AC Adaptor, Input Rating: 100-240V~, 50-60 Hz, IEC 60320/C14 , Output Rating: 36W, 48.0V@0.75A, Output Configuration: N/A mm, N/A/ Cond, N/A, None, Ferrite: None, N/A, GT Cord # C0745, Pin Out: PoE injector wiring Data, Data+Power, RJ45 x 2, Blades/Input Cord: Not Applicable, Approvals: CB 62368; Patent US9838207B2; EAC; CCC; S-Mark 60950; PSE; PSE; CE; China RoHS; Class I; Level VI; RoHS; Ukraine; VCCI; WEEE; RCM; CB 60335; ETL;</p> <p>Model No. GT-96300-3648-T3-PP</p> <p>Part No./Ordering No. GT-96300-3648-T3-PP</p>
	Rev D

ELECTRICAL SPECIFICATIONS

GlobTek's GT-96300-3656 Active Power over Ethernet Midspan Injector offers a cost effective and reliable solution for remote powering of wireless LAN Access Points, voice over IP (VoIP) phones, security cameras, RFID readers and other IP terminals up to 36W, using existing network infrastructure. This injector is configured to provide 36W of power per port over two pairs (Mode B) in compliance with IEEE 802.3at standard.

The GT-96300-3656 Active PoE Injector is designed to function with and provide power to any IEEE 802.3at compliant PoE device.

MAIN FEATURES

- Withstands high energy EMI immunity events without going into latched shutdown state
- Enhanced 36W output power capability
- IEEE 802.3at detection, 2 Event classification, disconnect and overload protection
- LED user interface for "power good" and fault conditions
- Compliant to PoE+, 10/100/1000 Base-T data rates
- Universal input power from 100V_{AC} to 240V_{AC}
- Unique patented green design: Compliant to DoE Efficiency level VI requirement
- Full protection for over-voltage and over-current
- Compact 104 x 54 x 40 mm (w/o mounting flange)

APPLICATIONS

- VoIP Phones
- VoIP Phone with Video
- Wireless Access Points
- Bluetooth Access Points
- Multi-Band Wireless Access Points
- Network Security Cameras
- Point of Sales
- Industrial Controllers
- Electronic Time Card Readers
- Building Security Systems
- Network Camera with Pan, Tilt and Zoom Features
- Electronic Signs
- RFID Readers

PROPRIETARY INFORMATION

PROPRIETARY OF GLOBTEK, INC. ANY REPRODUCTION, DISCLOSURE OR USE OF THIS DRAWING, IN WHOLE OR IN PART, IS HEREBY PROHIBITED EXCEPT AS SPECIFIED IN WRITING BY GLOBTEK, INC. © GlobTek, Inc. 2017 - 2020

<p>GlobTek, Inc. www.globtek.com 186 Veterans Drive, Northvale, NJ 07647 Tel. (201) 784-1000 Fax (201) 784-0111</p>	<p>Drawing Title: GT-96300-3648-T3-PP, PoE, Passive Power Injector, Efficiency Level: USA DOE Level VI / Eco-design Directive 2009/125/EC, (EU) 2019/1782, Case Color/Style: GlobTek Black, Desktop/External, Single Port Passive Power Over Ethernet Midspan (Passive/Dumb PoE PSE) Power Supply AC Adaptor, Input Rating: 100-240V~, 50-60 Hz, IEC 60320/C14, Output Rating: 36W, 48.0V@0.75A, Output Configuration: N/A mm, N/A/ Cond, N/A, None, Ferrite: None, N/A, GT Cord # C0745, Pin Out: PoE injector wiring Data, Data+Power, RJ45 x 2, Blades/Input Cord: Not Applicable, Approvals: CB 62368; Patent US9838207B2; EAC; CCC; S-Mark 60950; PSE; PSE; CE; China RoHS; Class I; Level VI; RoHS; Ukraine; VCCI; WEEE; RCM; CB 60335; ETL;</p> <p>Model No. GT-96300-3648-T3-PP</p> <p>Part No./Ordering No. GT-96300-3648-T3-PP</p>
	Rev D

- Motion Sensors
- HVAC Controllers
- Magnetic Card Readers
- PDAs
- Digital Time clock

A) ELECTRICAL SPECIFICATIONS

INPUT

Input Voltage: 90-264 V_{AC} (85-264V_{AC} @ 85% of rated output power)

Input Line Frequency: 47-63Hz

Input Current: <1A RMS @ 90V_{AC} Full Load

Inrush Current: 60A (typ.), cold start @ 25°C at 230V_{AC}

No load Power: <100mW

Efficiency: >87.4% (typ.), 4-point average efficiency, @ full load/230 V_{AC}

Turn on-delay: 1 second typical @ 115V_{AC}

Input Line Protection: MOV transient protected

Hold-up time: 8ms typical at nominal input voltage and full load

Leakage current: <100µA

Isolation: 3000 V_{AC}

OUTPUT

Number of Ports: 1

Data Rates: Compliant to PoE+, 10/100/1000 Mbits/second Ethernet speed

Power Injection Method:

IEEE 802.3at "Midspan" Mode B, using pins 4 & 5 (DC+) and 7 & 8 (DC-)

Mode A configuration, using pins 1 & 2 and 3 & 6 available upon special request

Please read our article [Power over Ethernet \(PoE\) Mode A vs. Mode B](#) for more information.

Port Voltage: 56V_{DC} (nom.), measured between pins 4 & 5 and 7 & 8

Port Current: 0 to 640mA (max.)

Port Power: 36W (max.)

Port Voltage Regulation: Complies with IEEE 802.3at requirements

Port Voltage Ripple: Complies with IEEE 802.3at requirements

Port Voltage Transient Performance: Complies with IEEE 802.3at requirements

<p>GlobTek, Inc. www.globtek.com 186 Veterans Drive, Northvale, NJ 07647 Tel. (201) 784-1000 Fax (201) 784-0111</p>	<p>Drawing Title: GT-96300-3648-T3-PP, PoE, Passive Power Injector, Efficiency Level: USA DOE Level VI / Eco-design Directive 2009/125/EC, (EU) 2019/1782, Case Color/Style: GlobTek Black, Desktop/External, Single Port Passive Power Over Ethernet Midspan (Passive/Dumb PoE PSE) Power Supply AC Adaptor, Input Rating: 100-240V~, 50-60 Hz, IEC 60320/C14, Output Rating: 36W, 48.0V@0.75A, Output Configuration: N/A mm, N/A/ Cond, N/A, None, Ferrite: None, N/A, GT Cord # C0745, Pin Out: PoE injector wiring Data, Data+Power, RJ45 x 2, Blades/Input Cord: Not Applicable, Approvals: CB 62368; Patent US9838207B2; EAC; CCC; S-Mark 60950; PSE; PSE; CE; China RoHS; Class I; Level VI; RoHS; Ukraine; VCCI; WEEE; RCM; CB 60335; ETL;</p> <p>Model No. GT-96300-3648-T3-PP</p> <p>Part No./Ordering No. GT-96300-3648-T3-PP</p>
	Rev D

Port Overload Protection: Complies with IEEE 802.3at Requirements. Port will shut down during overload and auto recover when overload is removed.

Port Short Circuit Protection: Complies with IEEE 802.3at Requirements. Port will shut down during short circuit and auto recover when short is removed.

Port Power Disconnection Method: Automatic disconnect if < 10mA minimum load detected per IEEE 802.3at standard.

USER INTERFACE

Green LED status indicator with four possible states:

1. No light: No powered device detected at end of Ethernet cable
2. Flashing at 1.5Hz: Detection (hand-shaking) in-process with Powered Device (PD)
3. Continuous light: Good connection with Powered Device (PD)
4. Flashing at 10Hz: Over current condition

B) ENVIRONMENTAL

Temperature (Operating): -10°C to 40°C

Temperature (Storage): -30°C to 80°C

Humidity: 0% to 95% relative humidity, non-condensing

Altitude: Operating, up to 5000m

C) MECHANICAL / ENCLOSURE

Housing: High impact plastic, 94V-0 polycarbonate, non-vented

Markings: Label, pad printed, and/or laser-etched onto the case

Dimensions: 104x54x40mm (w/o mounting flange)

Weight: 0.35lb (159g)

AC Input Mechanical Options:

Desktop with C6, C8, C14 or C18 IEC Inlet.

Hybrid housing (Desktop or inter-changeable blade wall plug-in), Class I or Class II input

Data and Data+Power Connector: Fully Shielded RJ45

D) EMISSIONS AND IMMUNITY

Emissions: Complies with FCC Class B Part 15, EN55022 Class B

Immunity: Complies with the following;:

EN61000-6-2 (Industrial Level Immunity Compliance, extended levels shown in parenthesis)

EN 61000-4-2 ESD (+/-18KV Air, +/-8KV Contact, criteria A) (+/-20KV Air, +/-10KV Contact, criteria B)

EN 61000-4-3 Radiated Immunity

EN 61000-4-4 EFT (+/-2.5KV, criteria A) (+/-4KV, criteria B)

<p>GlobTek, Inc. www.globtek.com 186 Veterans Drive, Northvale, NJ 07647 Tel. (201) 784-1000 Fax (201) 784-0111</p>	<p>Drawing Title: GT-96300-3648-T3-PP, PoE, Passive Power Injector, Efficiency Level: USA DOE Level VI / Eco-design Directive 2009/125/EC, (EU) 2019/1782, Case Color/Style: GlobTek Black, Desktop/External, Single Port Passive Power Over Ethernet Midspan (Passive/Dumb PoE PSE) Power Supply AC Adaptor, Input Rating: 100-240V~, 50-60 Hz, IEC 60320/C14 , Output Rating: 36W, 48.0V@0.75A, Output Configuration: N/A mm, N/A/ Cond, N/A, None, Ferrite: None, N/A, GT Cord # C0745, Pin Out: PoE injector wiring Data, Data+Power, RJ45 x 2, Blades/Input Cord: Not Applicable, Approvals: CB 62368; Patent US9838207B2; EAC; CCC; S-Mark 60950; PSE; PSE; CE; China RoHS; Class I; Level VI; RoHS; Ukraine; VCCI; WEEE; RCM; CB 60335; ETL;</p> <p>Model No. GT-96300-3648-T3-PP</p> <p>Part No./Ordering No. GT-96300-3648-T3-PP</p>	<p>Rev D</p>
---	---	--------------

EN 61000-4-5 Surge (+/-2KV Line-Line, +/-4KV Line to Gnd, criteria A)
EN 61000-4-6 Conducted Susceptibility
EN 61000-4-11 Voltage Dips and Interrupts
EN 61000-3-2 Harmonics, Class A

REGULATORY COMPLIANCE

Compliant Safety Standards: See listings at end of this drawing for specifics

IEEE 802.3at: Product tested per the requirements of IEEE 802.3at

INTEROPERABILITY: Product's interoperability performance verified with various third party PoE enabled systems. See table below.

SPECIAL OPTIONS

1. Custom markings
2. Reduced output power rating
3. Compatibility to 24W-30W output power splitters using Data Link Layer Classification
4. High reliability PCB laminate with plated through holes for IPC610 Class 2 compliance
5. Special housing colors
6. 48V to 54V output voltage, contact GlobTek for availability

GlobTek, Inc. www.globtek.com 186 Veterans Drive, Northvale, NJ 07647 Tel. (201) 784-1000 Fax (201) 784-0111	Drawing Title: GT-96300-3648-T3-PP, PoE, Passive Power Injector, Efficiency Level: USA DOE Level VI / Eco-design Directive 2009/125/EC, (EU) 2019/1782, Case Color/Style: GlobTek Black, Desktop/External, Single Port Passive Power Over Ethernet Midspan (Passive/Dumb PoE PSE) Power Supply AC Adaptor, Input Rating: 100-240V~, 50-60 Hz, IEC 60320/C14, Output Rating: 36W, 48.0V@0.75A, Output Configuration: N/A mm, N/A/ Cond, N/A, None, Ferrite: None, N/A, GT Cord # C0745, Pin Out: PoE injector wiring Data, Data+Power, RJ45 x 2, Blades/Input Cord: Not Applicable, Approvals: CB 62368; Patent US9838207B2; EAC; CCC; S-Mark 60950; PSE; PSE; CE; China RoHS; Class I; Level VI; RoHS; Ukraine; VCCI; WEEE; RCM; CB 60335; ETL;	
	Model No. GT-96300-3648-T3-PP	
	Part No./Ordering No. GT-96300-3648-T3-PP	Rev D

36W PoE Injector, Ethernet InterOperability and Compatibility Testing

Injector tested: *Model GT-96300-3656*, rated 36W output, 56Vdc, IEEE802.3-2009 at Compliant

Note, assuming 80% eff splitter, max Pout = 28.8W (28.8/36 = 0.8)

Splitter Model Used	Splitter Description	Splitter O/P Power Rating	Splitter Load During Testing
GlobTek GT-91087	5V, af type	8W	7.5W
PowerDSIne PD-AS-601/5	5V, af type	10W	
Linksys POEES5	5V, af type	10W	
Axis 5008-001-02	5V, af type	10W	
PowerDSIne PD-AS-701/12	12V, at type	24W	24W
Phihong POE21-120-R	12V, at type	21W	21W
Cisco 7970 Series Phone	IP Phone, af type	Input to Phone rating 48V, 0.38A	

* For 24W-30W output power Splitters using Data Link Layer Classification, contact GlobTek for option availability.

100BaseT/1000 Base T network digital transmission testing

(During testing ethernet communications is passed thru Injector and then Splitter and then to a computer)

Injector tested: *Model GT-96300-3656*, rated 36W output, 56Vdc, IEEE802.3-2009 at Compliant

Injector is Gigabit designed and tested, to 100 Base T and 1000 Base T

Splitter Model Used	Splitter Description	P/F	Notes:
Axis 5008-001-02	100 Base T rating	P	Limited bandwidth splitter
PowerDSIne PD-AS-701/12	1000 Base T rating	P	Full bandwidth splitter

TO ADDRESS SYSTEM-LEVEL EMI CONCERNS, FERRITE CHOKES/BEADS MAY BE ADDED/REVISED UPON REQUEST. A SAMPLE KIT OF GLOBTEK'S STANDARD FERRITES IS AVAILABLE UNDER GLOBTEK P/N: EMI-MITIGATION-KIT1

FOR ADDITIONAL INFORMATION, PLEASE READ OUR WHITE PAPER AT:

<https://en.globtek.com/technical-articles/ferrite-kit-radiated-emi-suppression-kit-for-globtek-power-supplies-cable-assemblies>

INGRESS PROTECTION: IP40

<p>GlobTek, Inc. www.globtek.com 186 Veterans Drive, Northvale, NJ 07647 Tel. (201) 784-1000 Fax (201) 784-0111</p>	<p>Drawing Title: GT-96300-3648-T3-PP, PoE, Passive Power Injector, Efficiency Level: USA DOE Level VI / Eco-design Directive 2009/125/EC, (EU) 2019/1782, Case Color/Style: GlobTek Black, Desktop/External, Single Port Passive Power Over Ethernet Midspan (Passive/Dumb PoE PSE) Power Supply AC Adaptor, Input Rating: 100-240V~, 50-60 Hz, IEC 60320/C14 , Output Rating: 36W, 48.0V@0.75A, Output Configuration: N/A mm, N/A/ Cond, N/A, None, Ferrite: None, N/A, GT Cord # C0745, Pin Out: PoE injector wiring Data, Data+Power, RJ45 x 2, Blades/Input Cord: Not Applicable, Approvals: CB 62368; Patent US9838207B2; EAC; CCC; S-Mark 60950; PSE; PSE; CE; China RoHS; Class I; Level VI; RoHS; Ukraine; VCCI; WEEE; RCM; CB 60335; ETL;</p> <p>Model No. GT-96300-3648-T3-PP</p> <p>Part No./Ordering No. GT-96300-3648-T3-PP</p>	<p>Rev D</p>
--	---	--------------

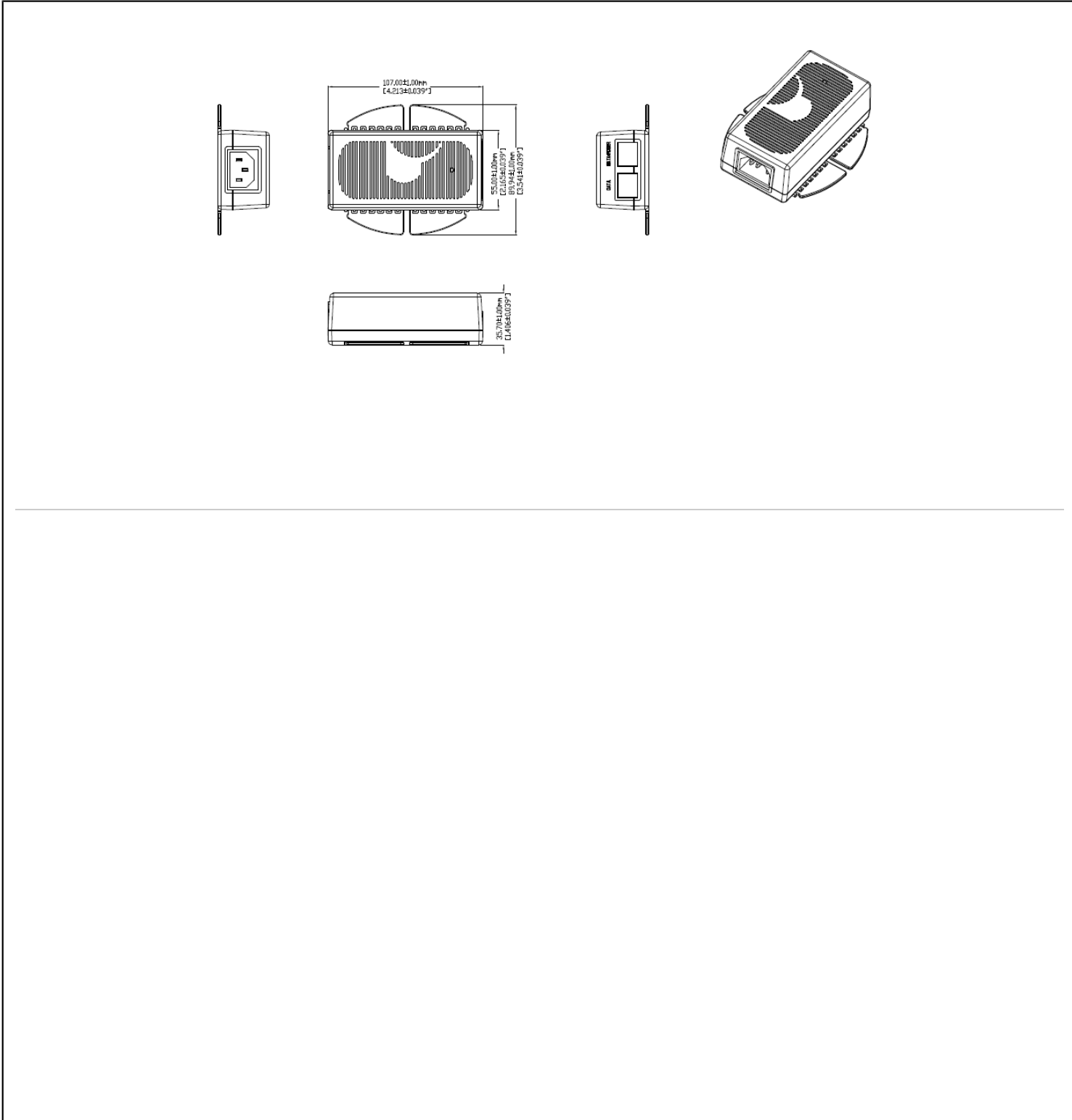

<p>GlobTek, Inc. www.globtek.com 186 Veterans Drive, Northvale, NJ 07647 Tel. (201) 784-1000 Fax (201) 784-0111</p>	<p>Drawing Title: GT-96300-3648-T3-PP, PoE, Passive Power Injector, Efficiency Level: USA DOE Level VI / Eco-design Directive 2009/125/EC, (EU) 2019/1782, Case Color/Style: GlobTek Black, Desktop/External, Single Port Passive Power Over Ethernet Midspan (Passive/Dumb PoE PSE) Power Supply AC Adaptor, Input Rating: 100-240V~, 50-60 Hz, IEC 60320/C14, Output Rating: 36W, 48.0V@0.75A, Output Configuration: N/A mm, N/A/ Cond, N/A, None, Ferrite: None, N/A, GT Cord # C0745, Pin Out: PoE injector wiring Data, Data+Power, RJ45 x 2, Blades/Input Cord: Not Applicable, Approvals: CB 62368; Patent US9838207B2; EAC; CCC; S-Mark 60950; PSE; PSE; CE; China RoHS; Class I; Level VI; RoHS; Ukraine; VCCI; WEEE; RCM; CB 60335; ETL;</p> <p>Model No. GT-96300-3648-T3-PP</p> <p>Part No./Ordering No. GT-96300-3648-T3-PP</p>	<p>Rev D</p>
--	--	--------------

DERATING CURVE

**Typical External
Power Supply Derating Curve**

(For Efficiency Level V and Efficiency Level VI Products)

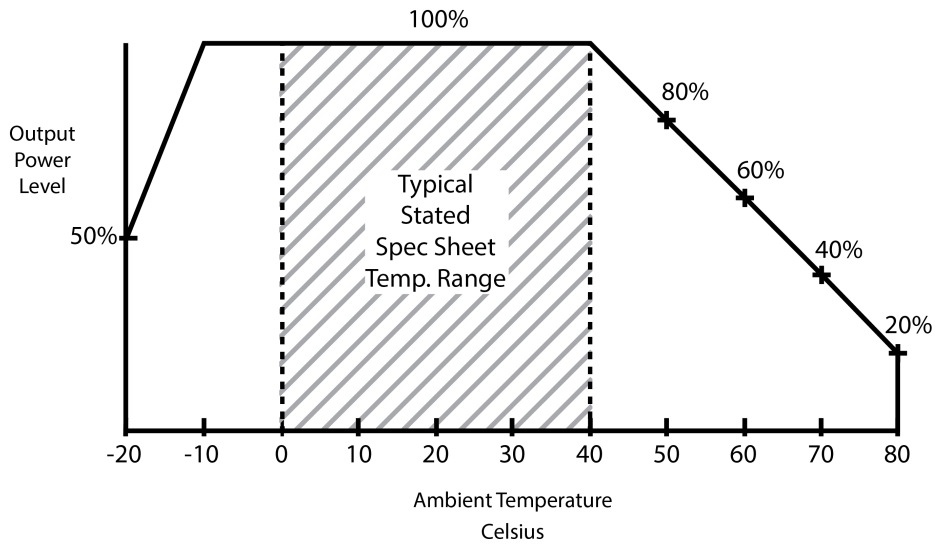

<p>GlobTek, Inc. www.globtek.com 186 Veterans Drive, Northvale, NJ 07647 Tel. (201) 784-1000 Fax (201) 784-0111</p>	<p>Drawing Title: GT-96300-3648-T3-PP, PoE, Passive Power Injector, Efficiency Level: USA DOE Level VI / Eco-design Directive 2009/125/EC, (EU) 2019/1782, Case Color/Style: GlobTek Black, Desktop/External, Single Port Passive Power Over Ethernet Midspan (Passive/Dumb PoE PSE) Power Supply AC Adaptor, Input Rating: 100-240V~, 50-60 Hz, IEC 60320/C14 , Output Rating: 36W, 48.0V@0.75A, Output Configuration: N/A mm, N/A/ Cond, N/A, None, Ferrite: None, N/A, GT Cord # C0745, Pin Out: PoE injector wiring Data, Data+Power, RJ45 x 2, Blades/Input Cord: Not Applicable, Approvals: CB 62368; Patent US9838207B2; EAC; CCC; S-Mark 60950; PSE; PSE; CE; China RoHS; Class I; Level VI; RoHS; Ukraine; VCCI; WEEE; RCM; CB 60335; ETL;</p> <p>Model No. GT-96300-3648-T3-PP</p> <p>Part No./Ordering No. GT-96300-3648-T3-PP</p>	<p>Rev D</p>
---	---	--------------

INPUT CONFIGURATION

(F3) Floating output/Isolated Common by Capacitor

GTM21089, GTM21097 and
GTM961600 Optional Config

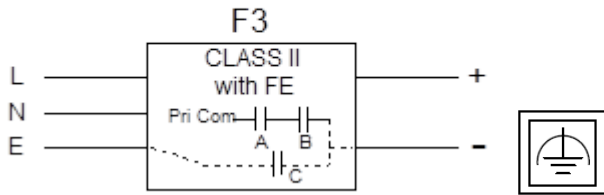

[Alternate grounding configurations](#) available upon request.

Blades/Cord Included:N/A:

Blades/Cord Installed:N/A:

IEC 60320/C14 AC Inlet Connector, Class I, Earth Ground

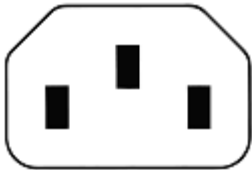

Mates with IEC 60320/C13 Plug

Optional Locking IEC60320 Receptable and cord option available on some models by request.:



[Standard International IEC 320/C13 Cordsets](#)

Below are standard cordsets which are "not included" (unless stated above); these can be purchased separately or packaged with the power supply. Contact your Sales Engineer if the style required is not shown below. Many more available in different lengths, colors or cable material.

Stock Power Supply Cords

				Length
--	--	--	--	--------

GlobTek, Inc. www.globtek.com 186 Veterans Drive, Northvale, NJ 07647 Tel. (201) 784-1000 Fax (201) 784-0111	Drawing Title: GT-96300-3648-T3-PP, PoE, Passive Power Injector, Efficiency Level: USA DOE Level VI / Eco-design Directive 2009/125/EC, (EU) 2019/1782, Case Color/Style: GlobTek Black, Desktop/External, Single Port Passive Power Over Ethernet Midspan (Passive/Dumb PoE PSE) Power Supply AC Adaptor, Input Rating: 100-240V~, 50-60 Hz, IEC 60320/C14 , Output Rating: 36W, 48.0V@0.75A, Output Configuration: N/A mm, N/A/ Cond, N/A, None, Ferrite: None, N/A, GT Cord # C0745, Pin Out: PoE injector wiring Data, Data+Power, RJ45 x 2, Blades/Input Cord: Not Applicable, Approvals: CB 62368; Patent US9838207B2; EAC; CCC; S-Mark 60950; PSE; PSE; CE; China RoHS; Class I; Level VI; RoHS; Ukraine; VCCI; WEEE; RCM; CB 60335; ETL;	
	Model No. GT-96300-3648-T3-PP	
	Part No./Ordering No. GT-96300-3648-T3-PP	Rev D

Part Number/ Link	Country	Plug	Termination	(mm)	(Ft)
3021457F701(R)	N. American (Type B)	NEMA 5-15P	IEC 320/C13	2150	7
1191068F0701(R)	N. American (Type B)	NEMA 5-15P Hospital	IEC 320/C13	2459	8
2194272M5701-T(R)	Argentina (Type I)	IRAM 2073	IEC 320/C13	2500	8
5502022M5701A(R)	Australian (Type I)	AS3112 / 3 PRONG	IEC 320/C13	2500	8
204B4272M5701(R)	Brazil (Type N)	BRAZIL	IEC 320/C13	2500	8
6023602M5701(R)	China (Type I)	CCC GR2099	IEC 320/C13	2500	8
G8014272M5701(R)	Danish (Type K)	AFSNIT SECTION 107-2-D1	IEC 320/C13	2500	8
23144272M5701-T(R)	Europe (Type E)	CEE 7/7	IEC 320/C13	2500	8
205IN4272M5701(R)	India (Type D)	India IS 1293 (also known as IA16A3 or BS546)	IEC 320/C13	2500	8
208IN4272M5701(R)	India (Type M)	India IS 1293 (also known as IA16A3 or BS546)	IEC320/C13	2500	8
377C4272M5701(R)	Israel (Type H)	ISL 377C	IEC 320/C13	2500	8
23024272M5701(R)	Italy (Type L)	CEI 23-16/VII	IEC 320/C13	2500	8
3003339F701(R) [3x1.25mm2]	Japan (Type B)	JIS 8303 / 3 PINS	IEC 320/C13	2500	8
3003068F2701-HK(R) [3 x 2.0mm2]					
302J115J6F0701J(R)	Japan / North America (Type B – 12A)	JIS 8303 / 3 PINS and NEMA 5-15P (PSE and UL/CUL appr)	IEC 320/C13	1830	6
302J104J6F0701J(R)	Japan / North America (Type B – 15A)	JIS 8303 / 3 PINS and NEMA 5-15P (PSE and UL/CUL appr)	IEC 320/C13	1830	6
2313K3432M5701(R)	Korea (Type F)	KS C 8305	IEC 320/C13	2500	8
5804272M5701(R)	Russia (Type F)	GOST 7396	IEC 320/C13	2500	8
2084272M5701(R)	South Africa (Type M)	South Africa SABS164-1 (16A type)	IEC 320/C13	2500	8
23214272M5701(R)	Switzerland (Type J)	SEV 1011	IEC 320/C13	2500	8
3003322M5701(R)	Taiwan (Type B)	BSMI	IEC 320/C13	2500	8
PZ0800100-2M5BK13H(R)	UK, Hong Kong, Singapore, Gulf States (Type G)	BS 1363A	IEC 320/C13	2500	8
7055002M5701A(R)	International	IEC 320 C14-C13	IEC 320/C13	2500	8

GlobTek, Inc. www.globtek.com 186 Veterans Drive, Northvale, NJ 07647 Tel. (201) 784-1000 Fax (201) 784-0111	Drawing Title: GT-96300-3648-T3-PP, PoE, Passive Power Injector, Efficiency Level: USA DOE Level VI / Eco-design Directive 2009/125/EC, (EU) 2019/1782, Case Color/Style: GlobTek Black, Desktop/External, Single Port Passive Power Over Ethernet Midspan (Passive/Dumb PoE PSE) Power Supply AC Adaptor, Input Rating: 100-240V~, 50-60 Hz, IEC 60320/C14 , Output Rating: 36W, 48.0V@0.75A, Output Configuration: N/A mm, N/A/ Cond, N/A, None, Ferrite: None, N/A, GT Cord # C0745, Pin Out: PoE injector wiring Data, Data+Power, RJ45 x 2, Blades/Input Cord: Not Applicable, Approvals: CB 62368; Patent US9838207B2; EAC; CCC; S-Mark 60950; PSE; PSE; CE; China RoHS; Class I; Level VI; RoHS; Ukraine; VCCI; WEEE; RCM; CB 60335; ETL;	
	Model No. GT-96300-3648-T3-PP	
	Part No./Ordering No. GT-96300-3648-T3-PP	Rev D

OUTPUT CORD AND CONNECTOR: None/C0745

ACTUAL CONNECTORS, OVERMOLDS, FERRITES MAY VARY SLIGHTLY FROM THE PICTURE BELOW

CABLE TYPE	N/A
CABLE LENGTH (mm)	N/A
CABLE TOLERANCE (mm)	N/A
WIRE GAUGE (AWG)	N/A
CONDUCTORS	
HANK DIMENSION (mm)	N/A
CABLE / CONNECTOR OVERMOLD COLOR	N/A
FERRITE TYPE / DIMENSION	None
FERRITE # OF TURNS(Definition)	N/A
FERRITE DIMENSION FROM STRAIN RELIEF	N/A
FERRITE DIMENSION FROM PLUG	N/A
PLUG TYPE	None
OUTPUT CONNECTOR SEX	
OVERMOLDED	
OVER MOLD ORIENTATION	N/A
CONNECTOR PIN OUT:	PoE injector wiring Data, Data+Power, RJ45 x 2

ADDITIONAL REQUIREMENTS

ADDITIONAL OUTPUT PLUG OPTIONS ARE AVAILABLE AT <https://www.globtek.com/connectors/>
STANDARD PLUGS AND CONNECTORS CAN BE SEEN ONLINE AT <https://www.globtek.com/connectors/>

TO ADDRESS SYSTEM-LEVEL EMI CONCERNS, FERRITE CHOKES/BEADS MAY BE ADDED/REVISED UPON REQUEST. A SAMPLE KIT OF GLOBTEK'S STANDARD FERRITES IS AVAILABLE UNDER GLOBTEK P/N: EMI-MITIGATION-KIT1

FOR ADDITIONAL INFORMATION, PLEASE READ OUR WHITE PAPER AT:

<https://en.globtek.com/technical-articles/ferrite-kit-radiated-emi-suppression-kit-for-globtek-power-supplies-cable-assemblies>

GlobTek, Inc. www.globtek.com 186 Veterans Drive, Northvale, NJ 07647 Tel. (201) 784-1000 Fax (201) 784-0111	Drawing Title: GT-96300-3648-T3-PP, PoE, Passive Power Injector, Efficiency Level: USA DOE Level VI / Eco-design Directive 2009/125/EC, (EU) 2019/1782, Case Color/Style: GlobTek Black, Desktop/External, Single Port Passive Power Over Ethernet Midspan (Passive/Dumb PoE PSE) Power Supply AC Adaptor, Input Rating: 100-240V~, 50-60 Hz, IEC 60320/C14 , Output Rating: 36W, 48.0V@0.75A, Output Configuration: N/A mm, N/A/ Cond, N/A, None, Ferrite: None, N/A, GT Cord # C0745, Pin Out: PoE injector wiring Data, Data+Power, RJ45 x 2, Blades/Input Cord: Not Applicable, Approvals: CB 62368; Patent US9838207B2; EAC; CCC; S-Mark 60950; PSE; PSE; CE; China RoHS; Class I; Level VI; RoHS; Ukraine; VCCI; WEEE; RCM; CB 60335; ETL;	
	Model No. GT-96300-3648-T3-PP	Rev D
Part No./Ordering No. GT-96300-3648-T3-PP		

LABEL:L-1186

LABEL P/N:	Standard GT
MATERIAL:	Flat Thermal Transfer, Imprintable, Polyester Label and/or Pad Printed and/or Molded, and/or Laser Engraved in the case
BACKGROUND COLOR:	Black if housing is Black, White or Silver if housing is White or Gray.
TEXT COLOR:	White or Silver if label is Black Background for Black housing. Black if label is White or Silver background and Housing is White or Gray.
LABEL WIDTH (mm):	40
LABEL HEIGHT (mm):	80
SPECIAL BARCODE LABEL MATERIAL:	

Below is the minimum information which will appear on the label. NOTE: in the logo area additional/actual positioning of symbols and text is subjected to change as per agency updates/requirements or additional model approvals become available. Regulatory certifications/label markings may be in logo area on the label or molded into the case housing outside the label area. Information will be shown via label and/or pad printed and/or molded and/or laser engraved in the case. * Date code markings at GlobTek option.

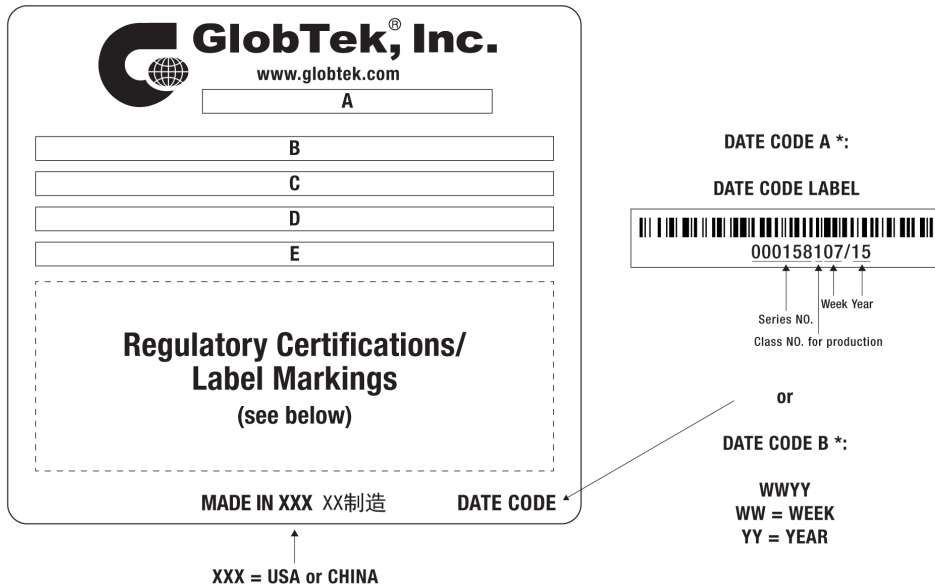

A=PoE, Passive Power Injector
B=P/N: (料号) GT-96300-3648-T3-PP
C=Model (型号) GT-96300-3648-T3-PP
D=Input (输入)100-240V~, 50-60 Hz, 1.0A
E=Output (输出)48.0 V --- 0.75 A, 36.0W

<p>GlobTek, Inc. www.globtek.com 186 Veterans Drive, Northvale, NJ 07647 Tel. (201) 784-1000 Fax (201) 784-0111</p>	<p>Drawing Title: GT-96300-3648-T3-PP, PoE, Passive Power Injector, Efficiency Level: USA DOE Level VI / Eco-design Directive 2009/125/EC, (EU) 2019/1782, Case Color/Style: GlobTek Black, Desktop/External, Single Port Passive Power Over Ethernet Midspan (Passive/Dumb PoE PSE) Power Supply AC Adaptor, Input Rating: 100-240V~, 50-60 Hz, IEC 60320/C14 , Output Rating: 36W, 48.0V@0.75A, Output Configuration: N/A mm, N/A/ Cond, N/A, None, Ferrite: None, N/A, GT Cord # C0745, Pin Out: PoE injector wiring Data, Data+Power, RJ45 x 2, Blades/Input Cord: Not Applicable, Approvals: CB 62368; Patent US9838207B2; EAC; CCC; S-Mark 60950; PSE; PSE; CE; China RoHS; Class I; Level VI; RoHS; Ukraine; VCII; WEEE; RCM; CB 60335; ETL;</p> <p>Model No. GT-96300-3648-T3-PP</p> <p>Part No./Ordering No. GT-96300-3648-T3-PP</p>	<p>Rev D</p>
---	---	--------------

AGENCY ONLINE DOCUMENTS	http://www.globtek.info/certs/GT-96300-POE/
CE EC-Declaration for Medical	Contact GlobTek for more information
CE EC-Declaration for Industrial/Commercial/ITE	http://globtek.force.com/models/ec_declaration_product?id=01ta0000007dRHc&i=3
CE EC-Declaration for Household	Contact GlobTek for more information
Morocco SDoC Declaration	https://globtek.secure.force.com/models/Morocco_SDoC_Declaration?id=a00a000000MnJfREAV
RoHS/RoHS3 Declaration	https://www.globtek.com/pdf/rohs_cert/01ta0000007dRHcAAM
REACH Declaration	https://www.globtek.com/pdf/iso_certificates/REACH.pdf
Conflict Minerals Declaration	https://www.globtek.com/pdf/conflict-minerals.pdf
IPXY rating is based on 3rd party testing and customers should check suitability and test system level IPXY rating before ordering.	

Regulatory Certifications/Label Markings

LATEST PRODUCT/MODEL CERTIFICATIONS: <http://en.globtek.com/datasheet/id/a00a000000MnJfR>

AGENCY ONLINE DOCUMENTS: <http://www.globtek.info/certs/GT-96300-POE/>



(F3) Floating output/Isolated Common by Capacitor

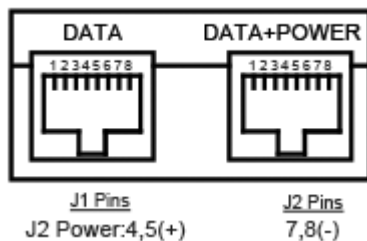

PoE injector wiring Data, Data+Power, RJ45 x 2

<p>GlobTek, Inc. www.globtek.com 186 Veterans Drive, Northvale, NJ 07647 Tel. (201) 784-1000 Fax (201) 784-0111</p>	<p>Drawing Title: GT-96300-3648-T3-PP, PoE, Passive Power Injector, Efficiency Level: USA DOE Level VI / Eco-design Directive 2009/125/EC, (EU) 2019/1782, Case Color/Style: GlobTek Black, Desktop/External, Single Port Passive Power Over Ethernet Midspan (Passive/Dumb PoE PSE) Power Supply AC Adaptor, Input Rating: 100-240V~, 50-60 Hz, IEC 60320/C14, Output Rating: 36W, 48.0V@0.75A, Output Configuration: N/A mm, N/A/ Cond, N/A, None, Ferrite: None, N/A, GT Cord # C0745, Pin Out: PoE injector wiring Data, Data+Power, RJ45 x 2, Blades/Input Cord: Not Applicable, Approvals: CB 62368; Patent US9838207B2; EAC; CCC; S-Mark 60950; PSE; PSE; CE; China RoHS; Class I; Level VI; RoHS; Ukraine; VCCI; WEEE; RCM; CB 60335; ETL;</p> <p>Model No. GT-96300-3648-T3-PP</p> <p>Part No./Ordering No. GT-96300-3648-T3-PP</p>	<p>Rev D</p>
---	--	--------------

PACKAGING

Packing Spec P/N:	Standard DT, Individually Box
Box Qty:	60
Gift Box Size (mm):	125*105*43
Gift Box Color:	White
Master Carton Size (mm):	442 x 330 x 275
Master Carton Cubic Volume (m³):	0.04
Master GW (Kg):	kg
BLADES INCLUDED:	N/A:
BLADE/CORD INSTALLED:	N/A:
USER MANUAL:	
USER MANUAL WEB LINK:	

If specific packaging is required, this section must specify all requirements and note "no exceptions". If this section does not specify packaging, it is subject to change without notice at GlobTek's discretion

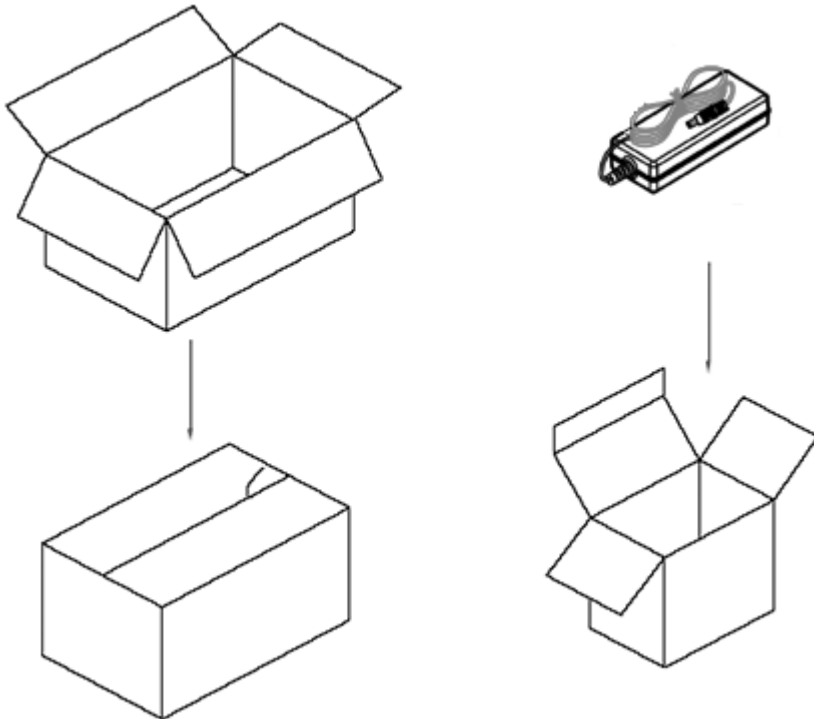

<p>GlobTek, Inc. www.globtek.com 186 Veterans Drive, Northvale, NJ 07647 Tel. (201) 784-1000 Fax (201) 784-0111</p>	<p>Drawing Title: GT-96300-3648-T3-PP, PoE, Passive Power Injector, Efficiency Level: USA DOE Level VI / Eco-design Directive 2009/125/EC, (EU) 2019/1782, Case Color/Style: GlobTek Black, Desktop/External, Single Port Passive Power Over Ethernet Midspan (Passive/Dumb PoE PSE) Power Supply AC Adaptor, Input Rating: 100-240V~, 50-60 Hz, IEC 60320/C14 , Output Rating: 36W, 48.0V@0.75A, Output Configuration: N/A mm, N/A/ Cond, N/A, None, Ferrite: None, N/A, GT Cord # C0745, Pin Out: PoE injector wiring Data, Data+Power, RJ45 x 2, Blades/Input Cord: Not Applicable, Approvals: CB 62368; Patent US9838207B2; EAC; CCC; S-Mark 60950; PSE; PSE; CE; China RoHS; Class I; Level VI; RoHS; Ukraine; VCCI; WEEE; RCM; CB 60335; ETL;</p> <p>Model No. GT-96300-3648-T3-PP</p> <p>Part No./Ordering No. GT-96300-3648-T3-PP</p>	<p>Rev D</p>
--	---	--------------

INSTRUCTIONS TO THE OEM SYSTEMS ENGINEER

It is the responsibility of the OEM systems engineer to provide the end system user instructions and warnings for the use of this product in the end system.

If an input cord is required for this product, AC Mains voltage should be provided to the power supply by a power supply cord approved to the national standards of the country in which it will be used.

This power supply is not designed to be repaired. No serviceable parts inside. A blown internal fuse is an indication of catastrophic failure of circuit component(s). If a Failure Analysis is required for a failed power supply/battery charger, please return the damaged unit to Globtek for an accurate determination of the root cause of the failure.

EMC Compliance of the complete OEM product, including the GlobTek power supply/battery charger needs to be verified by the OEM systems engineer.

INSTRUCTION SHEET

N/A