

GlobTek, Inc. www.globtek.com 186 Veterans Drive, Northvale, NJ 07647 Tel. (201) 784-1000 Fax (201) 784-0111	Drawing Title: GT-46200-2005-T3, ITE Power Supply, Efficiency Level: USA DOE Level VI / Eco-design Directive 2009/125/EC, (EU) 2019/1782, Case Color/Style: GlobTek Black, Desktop/External, Regulated Switchmode AC-DC Power Supply AC Adaptor, Input Rating: 100-240V~, 50-60 Hz, IEC 60320/C14 , Output Rating: 20W, 5.0V@4.0A, Output Configuration: 1200 mm, 16/2 Cond, UL 2468, Female Barrel 5.5*2.1*11mm w/ Spring Clip & Locking Notch or Equal, Ferrite: Core Size: 14.2*28.5*8.2, GlobTek Black, GT Cord # C9114, Pin Out: Center Positive (+V), Blades/Input Cord: Not Applicable, Approvals: 230V CoC Tier 2; EAC; Morocco; CB 62368; SIQ; SGS (GS); CE; China RoHS; IP40; Level VI; LPS 60950; PSE; RoHS; Ukraine; VCCI; WEEE; Class I; CCC; PSE; cULus; RCM; India (5V only);	
	Model No. GT-46200-2005-T3	
Part No./Ordering No. TR9CA4000CCP-N(R6B)		
Rev C		

REVISION HISTORY

REV	DESCRIPTION	SUB	DATE	APPROVED
C	Update dimension Ferrite From StrainRelief to 50±10 mm, Update BIS & CCC; add EAC; change RoHS 2 to RoHS	QA	02/07/2018	QA
B1	Revised packaging: change from egg crate to gift box	rchiu	10/31/2017	QA
B	Update packaging	rchiu	09/18/2017	QA
A	Initial Release	jwarn	05/02/2017	QA

In Addition to GlobTek Inc.'s renewed ISO9001:2015 - Quality Management System Certification, GlobTek Inc. is now certified to:

ISO13485:2016 - Medical Devices Quality Management System Certification
ISO14001:2015 - Environmental Management System Certification

ISO Certificates are available online at <https://www.globtek.com/iso-certificates/>

Customer Approval of Specification:

Please approve, sign and send back to GlobTek so we can complete order processing.

A delay in receipt of this form will delay delivery schedule.

Company Name:

Customer P/N:

Quote Number:

Date:

Authorized Representative Name:

Authorized Representative Signature:

The acceptance of this specification and use of the product described in this document indicates the acceptance and binding of the customer to Globtek terms and conditions, which supersede all other agreements, terms, and conditions (<https://en.globtek.com/terms-and-conditions/>).

The purchaser of this product (Customer) agrees that it is their sole responsibility to determine suitability/fitness of the product described in this specification for their application and to take precautions for protection against any hazards attendant to the handling and use of the product.

Footnote:

GlobTek Inc. will not be liable for the safety and performance of these power supplies if unauthorized access and repair occurs. End user should consult applicable UL, CSA or EN standards for proper installation instruction.

Limitation of Use:

GlobTek products are intended for use with commercial, medical, and/or industrial equipment only. GlobTek product are not authorized for use as mission critical components in life support hazardous environment, nuclear or aircraft applications without prior written approval from the CEO of GlobTek Inc.
Contents of this document are subject to change without prior notice.

GlobTek, Inc. www.globtek.com 186 Veterans Drive, Northvale, NJ 07647 Tel. (201) 784-1000 Fax (201) 784-0111	Drawing Title: GT-46200-2005-T3, ITE Power Supply, Efficiency Level: USA DOE Level VI / Eco-design Directive 2009/125/EC, (EU) 2019/1782, Case Color/Style: GlobTek Black, Desktop/External, Regulated Switchmode AC-DC Power Supply AC Adaptor, Input Rating: 100-240V~, 50-60 Hz, IEC 60320/C14 , Output Rating: 20W, 5.0V@4.0A, Output Configuration: 1200 mm, 16/2 Cond, UL 2468, Female Barrel 5.5*2.1*11mm w/ Spring Clip & Locking Notch or Equal, Ferrite: Core Size: 14.2*28.5*8.2, GlobTek Black, GT Cord # C9114, Pin Out: Center Positive (+V), Blades/Input Cord: Not Applicable, Approvals: 230V CoC Tier 2; EAC; Morocco; CB 62368; SIQ; SGS (GS); CE; China RoHS; IP40; Level VI; LPS 60950; PSE; RoHS; Ukraine; VCCI; WEEE; Class I; CCC; PSE; cULus; RCM; India (5V only);
	Model No. GT-46200-2005-T3 Part No./Ordering No. TR9CA4000CCP-N(R6B)

POWER SUPPLY INFORMATION

TYPE:	Desktop/External
TECHNOLOGY:	Regulated Switchmode AC-DC Power Supply AC Adaptor
CASE COLOR:	GlobTek Black
NAMEPLATE RATED INPUT:	100-240V~, 50-60 Hz, 0.5 A
INPUT CONFIG:	IEC 60320/C14
WATTS:	20.0
VOLTS OUT:	5.0
CURRENT OUT (Amps):	4.0
INGRESS PROTECTION:	Indoor Use
GROUNDING CONFIGURATION:	(E1) Earthed output
EFFICIENCY LEVEL:	
OUTPUT CONFIGURATION:	1200 mm, 16/2 Cond, UL 2468, Female Barrel 5.5*2.1*11mm w/ Spring Clip & Locking Notch or Equal, Ferrite: Core Size: 14.2*28.5*8.2, GlobTek Black, GT Cord # C9114
CONNECTOR PIN OUT:	Center Positive (+V)
LABEL SPECS:	Standard GT,L-1186
SPECIAL BARCODE LABEL	
MATERIAL:	
PACK SPEC:	
USER MANUAL:	

PROPRIETARY INFORMATION

PROPRIETARY OF GLOBTEK, INC. ANY REPRODUCTION, DISCLOSURE OR USE OF THIS DRAWING, IN WHOLE OR IN PART, IS HEREBY PROHIBITED EXCEPT AS SPECIFIED IN WRITING BY GLOBTEK, INC. © GlobTek, Inc. 2017 - 2020

<p>GlobTek, Inc. www.globtek.com 186 Veterans Drive, Northvale, NJ 07647 Tel. (201) 784-1000 Fax (201) 784-0111</p>	<p>Drawing Title: GT-46200-2005-T3, ITE Power Supply, Efficiency Level: USA DOE Level VI / Eco-design Directive 2009/125/EC, (EU) 2019/1782, Case Color/Style: GlobTek Black, Desktop/External, Regulated Switchmode AC-DC Power Supply AC Adaptor, Input Rating: 100-240V~, 50-60 Hz, IEC 60320/C14 , Output Rating: 20W, 5.0V@4.0A, Output Configuration: 1200 mm, 16/2 Cond, UL 2468, Female Barrel 5.5*2.1*11mm w/ Spring Clip & Locking Notch or Equal, Ferrite: Core Size: 14.2*28.5*8.2, GlobTek Black, GT Cord # C9114, Pin Out: Center Positive (+V), Blades/Input Cord: Not Applicable, Approvals: 230V CoC Tier 2; EAC; Morocco; CB 62368; SIQ; SGS (GS); CE; China RoHS; IP40; Level VI; LPS 60950; PSE; RoHS; Ukraine; VCCI; WEEE; Class I; CCC; PSE; cULus; RCM; India (5V only);</p>
	<p>Model No. GT-46200-2005-T3</p>
	<p>Part No./Ordering No. TR9CA4000CCP-N(R6B) Rev C</p>

Notes/Modifications/Customizations (notes in this section supersede the values shown in the standard spec):
DIMENSIONS ARE IN MM UNLESS SPECIFIED OTHERWISE.

GlobTek, Inc. www.globtek.com 186 Veterans Drive, Northvale, NJ 07647 Tel. (201) 784-1000 Fax (201) 784-0111	Drawing Title: GT-46200-2005-T3, ITE Power Supply, Efficiency Level: USA DOE Level VI / Eco-design Directive 2009/125/EC, (EU) 2019/1782, Case Color/Style: GlobTek Black, Desktop/External, Regulated Switchmode AC-DC Power Supply AC Adaptor, Input Rating: 100-240V~, 50-60 Hz, IEC 60320/C14 , Output Rating: 20W, 5.0V@4.0A, Output Configuration: 1200 mm, 16/2 Cond, UL 2468, Female Barrel 5.5*2.1*11mm w/ Spring Clip & Locking Notch or Equal, Ferrite: Core Size: 14.2*28.5*8.2, GlobTek Black, GT Cord # C9114, Pin Out: Center Positive (+V), Blades/Input Cord: Not Applicable, Approvals: 230V CoC Tier 2; EAC; Morocco; CB 62368; SIQ; SGS (GS); CE; China RoHS; IP40; Level VI; LPS 60950; PSE; RoHS; Ukraine; VCCI; WEEE; Class I; CCC; PSE; cULus; RCM; India (5V only);
	Model No. GT-46200-2005-T3 Part No./Ordering No. TR9CA4000CCP-N(R6B)

ELECTRICAL SPECIFICATIONS

A) ELECTRICAL SPECIFICATIONS:

01. Input Voltage: Specified 90-264 Vac, Nameplate rated: 100-240Vac
 02. Input Frequency: Specified 47-63 Hz, Nameplate rated 50-60Hz
 03. Inrush Current: 50A Max. at 115VAC cold start, 100A Max. at 230VAC cold start
 04. Average Efficiency: 82.44% Min (CEC & DOE LEVEL VI Compliant), 82.97% Min (ErP European Commission's Ecodesign Directive (2005/32/EC) / CoC Tier 2 Compliant)
 05. Input power(no load): <0.1W (CEC & DOE LEVEL VI Compliant), <0.075W (ErP European Commission's Ecodesign Directive (2005/32/EC) / CoC Tier 2 Compliant)
 07. Output Voltage tolerance: $\pm 5\%$
 08. Load regulation: $\pm 5\%$
 09. Output Voltage: Tolerance $\pm 5\%$
 10. Turn On Delay: 3000 mS MAX at 115 VAC Full Load
 11. Hold Up Time: 10 mS Min at 100 VAC Full Load
 12. Ripple Voltage: 150mV (p-p): Input :(100V-240VAC), Output:full load
- Measuring is done by 20MHz bandwidth oscilloscope and terminated each output with a 10uF aluminum electrolytic capacitor and 0.1uF ceramic capacitor.

B) PROTECTION

01. Over voltage protection: protection zener
02. Short circuit protection: Output shut down and auto- recover
03. Over Load Protection: Output shut down and auto restart

C) SAFETY

01. HI-POT : Input to output : 1500VAC or 2121VDC 10mA 1 minute
02. Leakage Current: <0.35mA
03. Earth continuity test:<0.1 Ohm or < 0.2 Ohm when with a non-detachable Power Supply cord, Class I Only
03. Insulation resistance: Input to output: 500vdc to test the input to output resistance not be less 100M ohm

D) EMC

01. Emissions, per EN 55032, EN 61000-6-3, EN 61000-6-4
Conducted Emissions: Class B, FCC Part 15, Class B
Radiated Emissions: Class B, FCC Part 15, Class B
02. Line Frequency Harmonics EN61000-3-2, Class A
03. Voltage Fluctuations/Flicker EN61000-3-3
04. Immunity, per EN 55024, EN 61000-6-1, EN 61000-6-2
Static Discharge Immunity EN61000-4-2, 4kV Contact Discharge, 8kV air discharge
Radiated RF Immunity EN61000-4-3, 3V/m 80-1000MHz, 80% 1KHz AM.
EFT/Burst Immunity EN61000-4-4, 1kV/100kHz.
Line Surge Immunity EN61000-4-5, 1kV differential, 2kV common-mode
Conducted RF Immunity EN61000-4-6, 3Vrms, 80% 1KHz AM
Power Frequency Magnetic Field Immunity EN61000-4-8, 1A/m
Voltage Dip Immunity EN61000-4-11, Criteria

E) OTHER:

01. MTBF: 200,000 Hours @ 25°C ambient temperature
02. Operating Temperature: 0°C to 40°C ambient temperature

PROPRIETARY INFORMATION

PROPRIETARY OF GLOBTEK, INC. ANY REPRODUCTION, DISCLOSURE OR USE OF THIS DRAWING, IN WHOLE OR IN PART, IS HEREBY PROHIBITED EXCEPT AS SPECIFIED IN

WRITING BY GLOBTEK, INC. © GlobTek, Inc. 2017 - 2020

quest /07/02/2020 7:48:28 PM

<p>GlobTek, Inc. www.globtek.com 186 Veterans Drive, Northvale, NJ 07647 Tel. (201) 784-1000 Fax (201) 784-0111</p>	<p>Drawing Title: GT-46200-2005-T3, ITE Power Supply, Efficiency Level: USA DOE Level VI / Eco-design Directive 2009/125/EC, (EU) 2019/1782, Case Color/Style: GlobTek Black, Desktop/External, Regulated Switchmode AC-DC Power Supply AC Adaptor, Input Rating: 100-240V~, 50-60 Hz, IEC 60320/C14 , Output Rating: 20W, 5.0V@4.0A, Output Configuration: 1200 mm, 16/2 Cond, UL 2468, Female Barrel 5.5*2.1*11mm w/ Spring Clip & Locking Notch or Equal, Ferrite: Core Size: 14.2*28.5*8.2, GlobTek Black, GT Cord # C9114, Pin Out: Center Positive (+V), Blades/Input Cord: Not Applicable, Approvals: 230V CoC Tier 2; EAC; Morocco; CB 62368; SIQ; SGS (GS); CE; China RoHS; IP40; Level VI; LPS 60950; PSE; RoHS; Ukraine; VCCI; WEEE; Class I; CCC; PSE; cULus; RCM; India (5V only);</p> <p>Model No. GT-46200-2005-T3</p> <p>Part No./Ordering No. TR9CA4000CCP-N(R6B)</p>
	<p>Rev C</p>

- 03. Humidity Operating : 20% to 80%. 0% to 90% relative humidity
- 04. Storage Temperature: -10°C to 70°C
Humidity Storage: 10% to 90%
- 05. RoHS 2: Complies with EU 2011/65/EU and China SJ/T 11364-2014

F) ENCLOSURE

- 01. Housing: High impact plastic, 94V0 polycarbonate, non-vented
- 02. Size: 80.6*50.0*31.0 +/-1.0 mm
- 03. Markings: Label and/or Pad Printed and/or Molded in the case

TO ADDRESS SYSTEM-LEVEL EMI CONCERNS, FERRITE CHOKES/BEADS MAY BE ADDED/REVISED UPON REQUEST. A SAMPLE KIT OF GLOBTEK'S STANDARD FERRITES IS AVAILABLE UNDER GLOBTEK P/N: EMI-MITIGATION-KIT1

FOR ADDITIONAL INFORMATION, PLEASE READ OUR WHITE PAPER AT:

<https://en.globtek.com/technical-articles/ferrite-kit-radiated-emi-suppression-kit-for-globtek-power-supplies-cable-assemblies>

INGRESS PROTECTION: Indoor Use

<p>GlobTek, Inc. www.globtek.com 186 Veterans Drive, Northvale, NJ 07647 Tel. (201) 784-1000 Fax (201) 784-0111</p>	<p>Drawing Title: GT-46200-2005-T3, ITE Power Supply, Efficiency Level: USA DOE Level VI / Eco-design Directive 2009/125/EC, (EU) 2019/1782, Case Color/Style: GlobTek Black, Desktop/External, Regulated Switchmode AC-DC Power Supply AC Adaptor, Input Rating: 100-240V~, 50-60 Hz, IEC 60320/C14, Output Rating: 20W, 5.0V@4.0A, Output Configuration: 1200 mm, 16/2 Cond, UL 2468, Female Barrel 5.5*2.1*11mm w/ Spring Clip & Locking Notch or Equal, Ferrite: Core Size: 14.2*28.5*8.2, GlobTek Black, GT Cord # C9114, Pin Out: Center Positive (+V), Blades/Input Cord: Not Applicable, Approvals: 230V CoC Tier 2; EAC; Morocco; CB 62368; SIQ; SGS (GS); CE; China RoHS; IP40; Level VI; LPS 60950; PSE; RoHS; Ukraine; VCCI; WEEE; Class I; CCC; PSE; cULus; RCM; India (5V only);</p> <p>Model No. GT-46200-2005-T3</p> <p>Part No./Ordering No. TR9CA4000CCP-N(R6B)</p>	<p>Rev C</p>
--	---	--------------

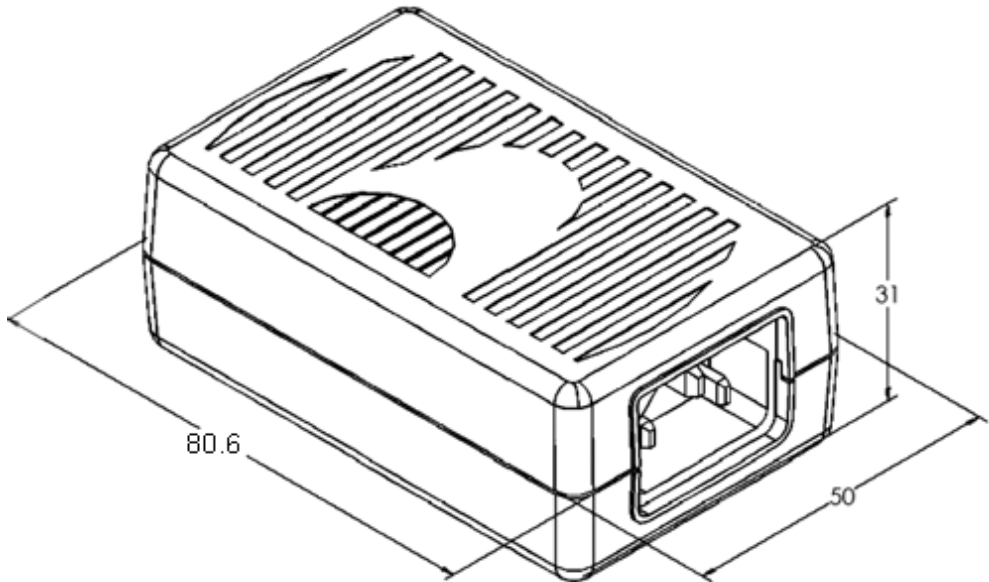

<p>GlobTek, Inc. www.globtek.com 186 Veterans Drive, Northvale, NJ 07647 Tel. (201) 784-1000 Fax (201) 784-0111</p>	<p>Drawing Title: GT-46200-2005-T3, ITE Power Supply, Efficiency Level: USA DOE Level VI / Eco-design Directive 2009/125/EC, (EU) 2019/1782, Case Color/Style: GlobTek Black, Desktop/External, Regulated Switchmode AC-DC Power Supply AC Adaptor, Input Rating: 100-240V~, 50-60 Hz, IEC 60320/C14 , Output Rating: 20W, 5.0V@4.0A, Output Configuration: 1200 mm, 16/2 Cond, UL 2468, Female Barrel 5.5*2.1*11mm w/ Spring Clip & Locking Notch or Equal, Ferrite: Core Size: 14.2*28.5*8.2, GlobTek Black, GT Cord # C9114, Pin Out: Center Positive (+V), Blades/Input Cord: Not Applicable, Approvals: 230V CoC Tier 2; EAC; Morocco; CB 62368; SIQ; SGS (GS); CE; China RoHS; IP40; Level VI; LPS 60950; PSE; RoHS; Ukraine; VCCI; WEEE; Class I; CCC; PSE; cULus; RCM; India (5V only);</p>
<p>Model No. GT-46200-2005-T3</p>	
<p>Part No./Ordering No. TR9CA4000CCP-N(R6B)</p>	<p>Rev C</p>

DERATING CURVE

**Typical External
Power Supply Derating Curve**

(For Efficiency Level V and Efficiency Level VI Products)

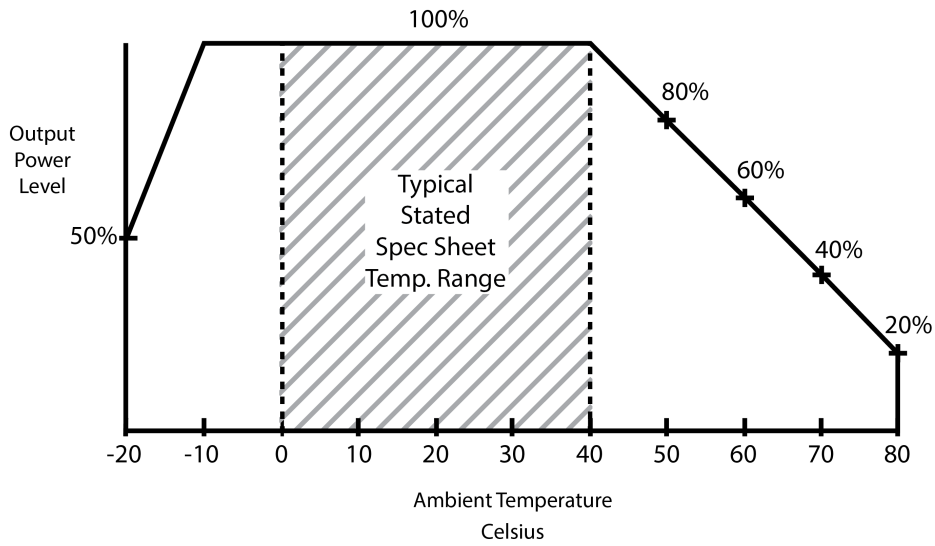

GlobTek, Inc. www.globtek.com 186 Veterans Drive, Northvale, NJ 07647 Tel. (201) 784-1000 Fax (201) 784-0111	Drawing Title: GT-46200-2005-T3, ITE Power Supply, Efficiency Level: USA DOE Level VI / Eco-design Directive 2009/125/EC, (EU) 2019/1782, Case Color/Style: GlobTek Black, Desktop/External, Regulated Switchmode AC-DC Power Supply AC Adaptor, Input Rating: 100-240V~, 50-60 Hz, IEC 60320/C14 , Output Rating: 20W, 5.0V@4.0A, Output Configuration: 1200 mm, 16/2 Cond, UL 2468, Female Barrel 5.5*2.1*11mm w/ Spring Clip & Locking Notch or Equal, Ferrite: Core Size: 14.2*28.5*8.2, GlobTek Black, GT Cord # C9114, Pin Out: Center Positive (+V), Blades/Input Cord: Not Applicable, Approvals: 230V CoC Tier 2; EAC; Morocco; CB 62368; SIQ; SGS (GS); CE; China RoHS; IP40; Level VI; LPS 60950; PSE; RoHS; Ukraine; VCCh; WEEE; Class I; CCC; PSE; cULus; RCM; India (5V only);	
	Model No. GT-46200-2005-T3	Rev C
Part No./Ordering No. TR9CA4000CCP-N(R6B)		

INPUT CONFIGURATION

(E1) Earthed output

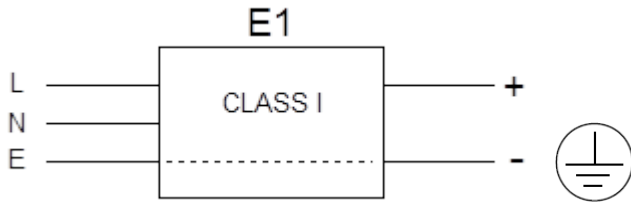

[Alternate grounding configurations](#) available upon request.

IEC 60320/C14 AC Inlet Connector, Class I, Earth Ground



Mates with IEC 60320/C13 Plug

Optional Locking IEC60320 Receptable and cord option available on some models by request.:



[Standard International IEC 320/C13 Cordsets](#)

Below are standard cordsets which are "not included" (unless stated above); these can be purchased separately or packaged with the power supply. Contact your Sales Engineer if the style required is not shown below. Many more available in different lengths, colors or cable material.

Stock Power Supply Cords

Part Number/ Link	Country	Plug	Termination	Length (mm)	(Ft)
3021457F701(R)	N. American (Type B)	NEMA 5-15P	IEC 320/C13	2150	7

PROPRIETARY INFORMATION

PROPRIETARY OF GLOBTEK, INC. ANY REPRODUCTION, DISCLOSURE OR USE OF THIS DRAWING, IN WHOLE OR IN PART, IS HEREBY PROHIBITED EXCEPT AS SPECIFIED IN WRITING BY GLOBTEK, INC. © GlobTek, Inc. 2017 - 2020

GloTek, Inc. www.globtek.com 186 Veterans Drive, Northvale, NJ 07647 Tel. (201) 784-1000 Fax (201) 784-0111	Drawing Title: GT-46200-2005-T3, ITE Power Supply, Efficiency Level: USA DOE Level VI / Eco-design Directive 2009/125/EC, (EU) 2019/1782, Case Color/Style: GlobTek Black, Desktop/External, Regulated Switchmode AC-DC Power Supply AC Adaptor, Input Rating: 100-240V~, 50-60 Hz, IEC 60320/C14 , Output Rating: 20W, 5.0V@4.0A, Output Configuration: 1200 mm, 16/2 Cond, UL 2468, Female Barrel 5.5*2.1*11mm w/ Spring Clip & Locking Notch or Equal, Ferrite: Core Size: 14.2*28.5*8.2, GlobTek Black, GT Cord # C9114, Pin Out: Center Positive (+V), Blades/Input Cord: Not Applicable, Approvals: 230V CoC Tier 2; EAC; Morocco; CB 62368; SIQ; SGS (GS); CE; China RoHS; IP40; Level VI; LPS 60950; PSE; RoHS; Ukraine; VCCI; WEEE; Class I; CCC; PSE; cULus; RCM; India (5V only);	
	Model No. GT-46200-2005-T3	
	Part No./Ordering No. TR9CA4000CCP-N(R6B)	Rev C

1191068F0701(R)	N. American (Type B)	NEMA 5-15P Hospital	IEC 320/C13	2459	8
2194272M5701-T(R)	Argentina (Type I)	IRAM 2073	IEC 320/C13	2500	8
5502022M5701A(R)	Australian (Type I)	AS3112 / 3 PRONG	IEC 320/C13	2500	8
204B4272M5701(R)	Brazil (Type N)	BRAZIL	IEC 320/C13	2500	8
6023602M5701(R)	China (Type I)	CCC GR2099	IEC 320/C13	2500	8
G8014272M5701(R)	Danish (Type K)	AFSNIT SECTION 107-2-D1	IEC 320/C13	2500	8
23144272M5701-T(R)	Europe (Type E)	CEE 7/7	IEC 320/C13	2500	8
205IN4272M5701(R)	India (Type D)	India IS 1293 (also known as IA16A3 or BS546)	IEC 320/C13	2500	8
208IN4272M5701(R)	India (Type M)	India IS 1293 (also known as IA16A3 or BS546)	IEC320/C13	2500	8
377C4272M5701(R)	Israel (Type H)	ISL 377C	IEC 320/C13	2500	8
23024272M5701(R)	Italy (Type L)	CEI 23-16/VII	IEC 320/C13	2500	8
3003339F701(R) [3x1.25mm2]	Japan (Type B)	JIS 8303 / 3 PINS	IEC 320/C13	2500	8
3003068F2701-HK(R) [3 x 2.0mm2]					
302J115J6F0701J(R)	Japan / North America (Type B – 12A)	JIS 8303 / 3 PINS and NEMA 5-15P (PSE and UL/CUL appr)	IEC 320/C13	1830	6
302J104J6F0701J(R)	Japan / North America (Type B – 15A)	JIS 8303 / 3 PINS and NEMA 5-15P (PSE and UL/CUL appr)	IEC 320/C13	1830	6
2313K3432M5701(R)	Korea (Type F)	KS C 8305	IEC 320/C13	2500	8
5804272M5701(R)	Russia (Type F)	GOST 7396	IEC 320/C13	2500	8
2084272M5701(R)	South Africa (Type M)	South Africa SABS164-1 (16A type)	IEC 320/C13	2500	8
23214272M5701(R)	Switzerland (Type J)	SEV 1011	IEC 320/C13	2500	8
3003322M5701(R)	Taiwan (Type B)	BSMI	IEC 320/C13	2500	8
PZ0800100-2M5BK13H(R)	UK, Hong Kong, Singapore, Gulf States (Type G)	BS 1363A	IEC 320/C13	2500	8
7055002M5701A(R)	International	IEC 320 C14-C13	IEC 320/C13	2500	8

GlobTek, Inc. www.globtek.com 186 Veterans Drive, Northvale, NJ 07647 Tel. (201) 784-1000 Fax (201) 784-0111	Drawing Title: GT-46200-2005-T3, ITE Power Supply, Efficiency Level: USA DOE Level VI / Eco-design Directive 2009/125/EC, (EU) 2019/1782, Case Color/Style: GlobTek Black, Desktop/External, Regulated Switchmode AC-DC Power Supply AC Adaptor, Input Rating: 100-240V~, 50-60 Hz, IEC 60320/C14 , Output Rating: 20W, 5.0V@4.0A, Output Configuration: 1200 mm, 16/2 Cond, UL 2468, Female Barrel 5.5*2.1*11mm w/ Spring Clip & Locking Notch or Equal, Ferrite: Core Size: 14.2*28.5*8.2, GlobTek Black, GT Cord # C9114, Pin Out: Center Positive (+V), Blades/Input Cord: Not Applicable, Approvals: 230V CoC Tier 2; EAC; Morocco; CB 62368; SIQ; SGS (GS); CE; China RoHS; IP40; Level VI; LPS 60950; PSE; RoHS; Ukraine; VCCI; WEEE; Class I; CCC; PSE; cULus; RCM; India (5V only);
	Model No. GT-46200-2005-T3 Part No./Ordering No. TR9CA4000CCP-N(R6B)

OUTPUT CORD AND CONNECTOR: CL1/C9114

ACTUAL CONNECTORS, OVERMOLDS, FERRITES MAY VARY SLIGHTLY FROM THE PICTURE BELOW

CABLE TYPE	UL 2468
CABLE LENGTH (mm)	1200
CABLE TOLERANCE (mm)	+150-0
WIRE GAUGE (AWG)	16
CONDUCTORS	2
HANK DIMENSION (mm)	80 +/-10
CABLE / CONNECTOR OVERMOLD COLOR	GlobTek Black
FERRITE TYPE / DIMENSION	Core Size: 14.2*28.5*8.2
FERRITE # OF TURNS (Definition)	2 Pass thru core (1 turns)
FERRITE DIMENSION FROM STRAIN RELIEF	50 +/-10
FERRITE DIMENSION FROM PLUG	N/A
PLUG TYPE	Female Barrel 5.5*2.1*11mm w/ Spring Clip & Locking Notch or Equal
OUTPUT CONNECTOR SEX	
OVERMOLDED	
OVER MOLD ORIENTATION	Straight
CONNECTOR PIN OUT:	Center Positive (+V)
ADDITIONAL REQUIREMENTS	

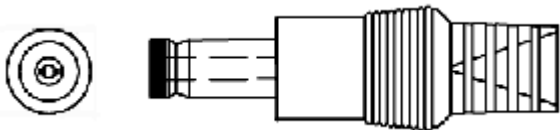

ADDITIONAL OUTPUT PLUG OPTIONS ARE AVAILABLE AT <https://www.globtek.com/connectors/>
STANDARD PLUGS AND CONNECTORS CAN BE SEEN ONLINE AT <https://www.globtek.com/connectors/>

<p>GlobTek, Inc. www.globtek.com 186 Veterans Drive, Northvale, NJ 07647 Tel. (201) 784-1000 Fax (201) 784-0111</p>	<p>Drawing Title: GT-46200-2005-T3, ITE Power Supply, Efficiency Level: USA DOE Level VI / Eco-design Directive 2009/125/EC, (EU) 2019/1782, Case Color/Style: GlobTek Black, Desktop/External, Regulated Switchmode AC-DC Power Supply AC Adaptor, Input Rating: 100-240V~, 50-60 Hz, IEC 60320/C14 , Output Rating: 20W, 5.0V@4.0A, Output Configuration: 1200 mm, 16/2 Cond, UL 2468, Female Barrel 5.5*2.1*11mm w/ Spring Clip & Locking Notch or Equal, Ferrite: Core Size: 14.2*28.5*8.2, GlobTek Black, GT Cord # C9114, Pin Out: Center Positive (+V), Blades/Input Cord: Not Applicable, Approvals: 230V CoC Tier 2; EAC; Morocco; CB 62368; SIQ; SGS (GS); CE; China RoHS; IP40; Level VI; LPS 60950; PSE; RoHS; Ukraine; VCCI; WEEE; Class I; CCC; PSE; cULus; RCM; India (5V only);</p>
	<p>Model No. GT-46200-2005-T3</p>
	<p>Part No./Ordering No. TR9CA4000CCP-N(R6B) Rev C</p>

OUTPUT CONNECTOR HOOK UP

TO ADDRESS SYSTEM-LEVEL EMI CONCERNS, FERRITE CHOKES/BEADS MAY BE ADDED/REVISED UPON REQUEST. A SAMPLE KIT OF GLOBTEK'S STANDARD FERRITES IS AVAILABLE UNDER GLOBTEK P/N: EMI-MITIGATION-KIT1

FOR ADDITIONAL INFORMATION, PLEASE READ OUR WHITE PAPER AT:

<https://en.globtek.com/technical-articles/ferrite-kit-radiated-emi-suppression-kit-for-globtek-power-supplies-cable-assemblies>

GlobTek, Inc. www.globtek.com 186 Veterans Drive, Northvale, NJ 07647 Tel. (201) 784-1000 Fax (201) 784-0111	Drawing Title: GT-46200-2005-T3, ITE Power Supply, Efficiency Level: USA DOE Level VI / Eco-design Directive 2009/125/EC, (EU) 2019/1782, Case Color/Style: GlobTek Black, Desktop/External, Regulated Switchmode AC-DC Power Supply AC Adaptor, Input Rating: 100-240V~, 50-60 Hz, IEC 60320/C14 , Output Rating: 20W, 5.0V@4.0A, Output Configuration: 1200 mm, 16/2 Cond, UL 2468, Female Barrel 5.5*2.1*11mm w/ Spring Clip & Locking Notch or Equal, Ferrite: Core Size: 14.2*28.5*8.2, GlobTek Black, GT Cord # C9114, Pin Out: Center Positive (+V), Blades/Input Cord: Not Applicable, Approvals: 230V CoC Tier 2; EAC; Morocco; CB 62368; SIQ; SGS (GS); CE; China RoHS; IP40; Level VI; LPS 60950; PSE; RoHS; Ukraine; VCCI; WEEE; Class I; CCC; PSE; cULus; RCM; India (5V only);	
	Model No. GT-46200-2005-T3	
	Part No./Ordering No. TR9CA4000CCP-N(R6B)	Rev C

LABEL:L-1186	
LABEL P/N:	Standard GT
MATERIAL:	Flat Thermal Transfer, Imprintable, Polyester Label and/or Pad Printed and/or Molded, and/or Laser Engraved in the case
BACKGROUND COLOR:	Black if housing is Black, White or Silver if housing is White or Gray.
TEXT COLOR:	White or Silver if label is Black Background for Black housing. Black if label is White or Silver background and Housing is White or Gray.
LABEL WIDTH (mm):	59.6
LABEL HEIGHT (mm):	39.6
SPECIAL BARCODE LABEL MATERIAL:	

GlobTek, Inc. www.globtek.com 186 Veterans Drive, Northvale, NJ 07647 Tel. (201) 784-1000 Fax (201) 784-0111	Drawing Title: GT-46200-2005-T3, ITE Power Supply, Efficiency Level: USA DOE Level VI / Eco-design Directive 2009/125/EC, (EU) 2019/1782, Case Color/Style: GlobTek Black, Desktop/External, Regulated Switchmode AC-DC Power Supply AC Adaptor, Input Rating: 100-240V~, 50-60 Hz, IEC 60320/C14, Output Rating: 20W, 5.0V@4.0A, Output Configuration: 1200 mm, 16/2 Cond, UL 2468, Female Barrel 5.5*2.1*11mm w/ Spring Clip & Locking Notch or Equal, Ferrite: Core Size: 14.2*28.5*8.2, GlobTek Black, GT Cord # C9114, Pin Out: Center Positive (+V), Blades/Input Cord: Not Applicable, Approvals: 230V CoC Tier 2; EAC; Morocco; CB 62368; SIQ; SGS (GS); CE; China RoHS; IP40; Level VI; LPS 60950; PSE; RoHS; Ukraine; VCCI; WEEE; Class I; CCC; PSE; cULus; RCM; India (5V only);
	Model No. GT-46200-2005-T3 Part No./Ordering No. TR9CA4000CCP-N(R6B)

Below is the minimum information which will appear on the label. NOTE: in the logo area additional/actual positioning of symbols and text is subjected to change as per agency updates/requirements or additional model approvals become available. Regulatory certifications/label markings may be in logo area on the label or molded into the case housing outside the label area. Information will be shown via label and/or pad printed and/or molded and/or laser engraved in the case. * Date code markings at GlobTek option

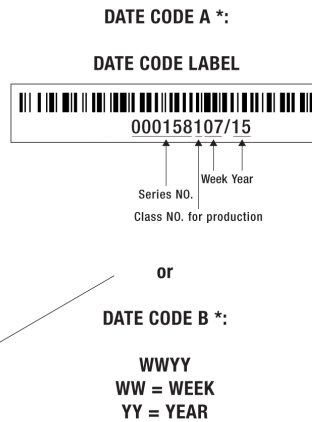

A=ITE Power Supply
 B=P/N: (料号) TR9CA4000CCP-N(R6B)
 C=Model (型号) GT-46200-2005-T3
 D=Input (输入)100-240V~, 50-60 Hz, 0.5 A
 E=Output (输出)5.0 V  4.0 A, 20.0W

AGENCY ONLINE DOCUMENTS	http://www.globtek.info/certs/GT-46200-20VV-X.X-TZ/
CE EC-Declaration for Medical	Contact GlobTek for more information
CE EC-Declaration for Industrial/Commercial/ITE	http://globtek.force.com/models/ec_declaration_product?id=01ta0000007dRHw&i=5
CE EC-Declaration for Household	Contact GlobTek for more information
Morocco SDoC Declaration	https://globtek.secure.force.com/models/Morocco_SDoC_Declaration?id=a0Oa000000MFI38EAH
RoHS/RoHS3 Declaration	https://www.globtek.com/pdf/rohs_cert/01ta0000007dRHwAAM
REACH Declaration	https://www.globtek.com/pdf/iso_certificates/REACH.pdf
Conflict Minerals Declaration	https://www.globtek.com/pdf/conflict-minerals.pdf

IPXY rating is based on 3rd party testing and customers should check suitability and test system level IPXY rating before ordering.

<p>GlobTek, Inc. www.globtek.com 186 Veterans Drive, Northvale, NJ 07647 Tel. (201) 784-1000 Fax (201) 784-0111</p>	<p>Drawing Title: GT-46200-2005-T3, ITE Power Supply, Efficiency Level: USA DOE Level VI / Eco-design Directive 2009/125/EC, (EU) 2019/1782, Case Color/Style: GlobTek Black, Desktop/External, Regulated Switchmode AC-DC Power Supply AC Adaptor, Input Rating: 100-240V~, 50-60 Hz, IEC 60320/C14 , Output Rating: 20W, 5.0V@4.0A, Output Configuration: 1200 mm, 16/2 Cond, UL 2468, Female Barrel 5.5*2.1*11mm w/ Spring Clip & Locking Notch or Equal, Ferrite: Core Size: 14.2*28.5*8.2, GlobTek Black, GT Cord # C9114, Pin Out: Center Positive (+V), Blades/Input Cord: Not Applicable, Approvals: 230V CoC Tier 2; EAC; Morocco; CB 62368; SIQ; SGS (GS); CE; China RoHS; IP40; Level VI; LPS 60950; PSE; RoHS; Ukraine; VCCI; WEEE; Class I; CCC; PSE; cULus; RCM; India (5V only);</p> <p>Model No. GT-46200-2005-T3</p> <p>Part No./Ordering No. TR9CA4000CCP-N(R6B)</p>
	<p>Rev C</p>

Regulatory Certifications/Label Markings

LATEST PRODUCT/MODEL CERTIFICATIONS: <http://en.globtek.com/datasheet/id/a00a00000MFI38>

AGENCY ONLINE DOCUMENTS: <http://www.globtek.info/certs/GT-46200-20VV-X.X-TZ/>



(E1) Earthed output

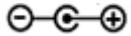

Center Positive (+V)

GlobTek, Inc. www.globtek.com 186 Veterans Drive, Northvale, NJ 07647 Tel. (201) 784-1000 Fax (201) 784-0111	Drawing Title: GT-46200-2005-T3, ITE Power Supply, Efficiency Level: USA DOE Level VI / Eco-design Directive 2009/125/EC, (EU) 2019/1782, Case Color/Style: GlobTek Black, Desktop/External, Regulated Switchmode AC-DC Power Supply AC Adaptor, Input Rating: 100-240V~, 50-60 Hz, IEC 60320/C14 , Output Rating: 20W, 5.0V@4.0A, Output Configuration: 1200 mm, 16/2 Cond, UL 2468, Female Barrel 5.5*2.1*11mm w/ Spring Clip & Locking Notch or Equal, Ferrite: Core Size: 14.2*28.5*8.2, GlobTek Black, GT Cord # C9114, Pin Out: Center Positive (+V), Blades/Input Cord: Not Applicable, Approvals: 230V CoC Tier 2; EAC; Morocco; CB 62368; SIQ; SGS (GS); CE; China RoHS; IP40; Level VI; LPS 60950; PSE; RoHS; Ukraine; VCCI; WEEE; Class I; CCC; PSE; cULus; RCM; India (5V only);	
	Model No. GT-46200-2005-T3	
	Part No./Ordering No. TR9CA4000CCP-N(R6B)	Rev C

PACKAGING

Packing Spec P/N:

Box Qty:	72
Gift Box Size (mm):	125*58*60
Gift Box Color:	White
Master Carton Size (mm):	520 x 370 x 205
Master Carton Cubic Volume (m³):	0.04
Master GW (Kg):	8.4 kg
BLADES INCLUDED:	:
BLADE/CORD INSTALLED:	:
USER MANUAL*:	
USER MANUAL WEB LINK:	

* This specification sheet is considered the user manual for all applications. It is expected that the buyer of this product will use it to formulate their own user manual for their end product and a user manual specifically for the power adapter is not usually required. If a user manual is not specifically listed above then none will be provided with this unit.

GlobTek, Inc. www.globtek.com 186 Veterans Drive, Northvale, NJ 07647 Tel. (201) 784-1000 Fax (201) 784-0111	Drawing Title: GT-46200-2005-T3, ITE Power Supply, Efficiency Level: USA DOE Level VI / Eco-design Directive 2009/125/EC, (EU) 2019/1782, Case Color/Style: GlobTek Black, Desktop/External, Regulated Switchmode AC-DC Power Supply AC Adaptor, Input Rating: 100-240V~, 50-60 Hz, IEC 60320/C14 , Output Rating: 20W, 5.0V@4.0A, Output Configuration: 1200 mm, 16/2 Cond, UL 2468, Female Barrel 5.5*2.1*11mm w/ Spring Clip & Locking Notch or Equal, Ferrite: Core Size: 14.2*28.5*8.2, GlobTek Black, GT Cord # C9114, Pin Out: Center Positive (+V), Blades/Input Cord: Not Applicable, Approvals: 230V CoC Tier 2; EAC; Morocco; CB 62368; SIQ; SGS (GS); CE; China RoHS; IP40; Level VI; LPS 60950; PSE; RoHS; Ukraine; VCCI; WEEE; Class I; CCC; PSE; cULus; RCM; India (5V only);	
	Model No. GT-46200-2005-T3	
	Part No./Ordering No. TR9CA4000CCP-N(R6B)	Rev C

INSTRUCTIONS TO THE OEM SYSTEMS ENGINEER

It is the responsibility of the OEM systems engineer to provide the end system user instructions and warnings for the use of this product in the end system.

If an input cord is required for this product, AC Mains voltage should be provided to the power supply by a power supply cord approved to the national standards of the country in which it will be used.

This power supply is not designed to be repaired. No serviceable parts inside. A blown internal fuse is an indication of catastrophic failure of circuit component(s). If a Failure Analysis is required for a failed power supply/battery charger, please return the damaged unit to Globtek for an accurate determination of the root cause of the failure.

EMC Compliance of the complete OEM product, including the GlobTek power supply/battery charger needs to be verified by the OEM systems engineer.

INSTRUCTION SHEET

N/A