

|   |  |       |
|---|--|-------|
| GlobTek, Inc.<br>www.globtek.com<br>186 Veterans Drive,<br>Northvale, NJ 07647<br>Tel. (201) 784-1000<br>Fax (201) 784-0111 | Drawing Title: GT-86060-0605-W2E, ITE Power Supply, Efficiency Level: VI, Case Color/Style: GlobTek Black, Wall Plug-in, Regulated Switchmode AC-DC Power Supply AC Adaptor, Input Rating: 100-240V~, 50/60Hz, Euro Plug Fixed , Output Rating: 6W, 5V@1.2A, Output Configuration: 1500 mm, 22/2 Cond, UL 2468, Micro USB type B without resistor, Ferrite: None, GlobTek Black, GT Cord # C7727, Pin Out: Pin 1: +V, Pin 2-4: N/C, Pin 5: GND, Blades/Input Cord: Fixed Blades European 7/7 2 Conductor, Approvals: Ukraine; LPS; China RoHS; RoHS; CE; PSE; CB 60950; Double Insulation; VCCI; WEEE; EAC; SGS; |       |
|   | Model No. GT-86060-0605-W2E  |       |
|   | Part No./Ordering No. WR9MA1200MICB-F(R6B)   | Rev C |

## REVISION HISTORY

| REV | DESCRIPTION                            | SUB   | DATE       | APPROVED |
|-----|--|-------|------------|----------|
| C   | Update packaging                       | rchiu | 11/09/2017 | QA       |
| B   | Update cable color from white to black | rchiu | 08/25/2017 | QA       |
| A   | Initial Release                        | jwarn | 05/02/2017 | QA       |

In Addition to GlobTek Inc.'s renewed ISO9001:2015 - Quality Management System Certification, GlobTek Inc. is now certified to:

ISO13485:2016 - Medical Devices Quality Management System Certification

ISO14001:2015 - Environmental Management System Certification

ISO Certificates are available online at <https://www.globtek.com/iso-certificates/>

### Customer Approval of Specification:

Please approve, sign and send back to GlobTek so we can complete order processing.

A delay in receipt of this form will delay delivery schedule.

Company Name:

Customer P/N:

Quote Number:

Date:

Authorized Representative Name:

Authorized Representative Signature:

The acceptance of this specification and use of the product described in this document indicates the acceptance and binding of the customer to Globtek terms and conditions, which supersede all other agreements, terms, and conditions (<https://en.globtek.com/terms-and-conditions/>).

### Footnote:

GlobTek Inc. will not be liable for the safety and performance of these power supplies if unauthorized access and repair occurs. End user should consult applicable UL, CSA or EN standards for proper installation instruction.

### Limitation of Use:

GlobTek products are intended for use with commercial, medical, and/or industrial equipment only. GlobTek product are not authorized for use as mission critical components in life support hazardous environment, nuclear or aircraft applications without prior written approval from the CEO of GlobTek Inc.

Contents of this document are subject to change without prior notice.

|   |  |       |
|---|--|-------|
| GlobTek, Inc.<br>www.globtek.com<br>186 Veterans Drive,<br>Northvale, NJ 07647<br>Tel. (201) 784-1000<br>Fax (201) 784-0111 | Drawing Title: GT-86060-0605-W2E, ITE Power Supply, Efficiency Level: VI, Case Color/Style: GlobTek Black, Wall Plug-in, Regulated Switchmode AC-DC Power Supply AC Adaptor, Input Rating: 100-240V~, 50/60Hz, Euro Plug Fixed , Output Rating: 6W, 5V@1.2A, Output Configuration: 1500 mm, 22/2 Cond, UL 2468, Micro USB type B without resistor, Ferrite: None, GlobTek Black, GT Cord # C7727, Pin Out: Pin 1: +V, Pin 2-4: N/C, Pin 5: GND, Blades/Input Cord: Fixed Blades European 7/7 2 Conductor, Approvals: Ukraine; LPS; China RoHS; RoHS; CE; PSE; CB 60950; Double Insulation; VCCI; WEEE; EAC; SGS; |       |
|   | Model No. GT-86060-0605-W2E  |       |
|   | Part No./Ordering No. WR9MA1200MICB-F(R6B)   | Rev C |

## POWER SUPPLY INFORMATION

TYPE: Wall Plug-in  
TECHNOLOGY: Regulated Switchmode AC-DC Power Supply AC Adaptor  
CASE COLOR: GlobTek Black  
NAMEPLATE RATED INPUT: 100-240V~, 50/60Hz, 0.2A  
INPUT CONFIG: Euro Plug Fixed  
WATTS: 6.0  
VOLTS OUT: 5  
CURRENT OUT (Amps): 1.2  
BLADE/CORD INCLUDED: FBEuro2  
BLADE/CORD INSTALLED: FBEuro2  
INGRESS PROTECTION: IPX0  
GROUNDING CONFIGURATION: (F1) Class II / Double Insulated  
EFFICIENCY LEVEL: VI  
OUTPUT CONFIGURATION: 1500 mm, 22/2 Cond, UL 2468, Micro USB type B without resistor, Ferrite: None, GlobTek Black, GT Cord # C7727  
CONNECTOR PIN OUT: Pin 1: +V, Pin 2-4: N/C, Pin 5: GND  
LABEL SPECS: Standard GT,L-1186  
SPECIAL BARCODE LABEL  
MATERIAL: No  
PACK SPEC: Standard WPI non changeable, Individually Box, User manual  
USER MANUAL: 809-DESKTOPUSERMANUAL

Notes/Modifications/Customizations (notes in this section supersede the values shown in the standard spec):

DIMENSIONS ARE IN MM UNLESS SPECIFIED OTHERWISE.

### PROPRIETARY INFORMATION

PROPRIETARY OF GLOBTEK, INC. ANY REPRODUCTION, DISCLOSURE OR USE OF THIS DRAWING, IN WHOLE OR IN PART, IS HEREBY PROHIBITED EXCEPT AS SPECIFIED IN WRITING BY GLOBTEK, INC. © GlobTek, Inc. 2017 - 2019

quest /05/20/2019 2:39:24 PM

|   |  |       |
|---|--|-------|
| GlobTek, Inc.<br>www.globtek.com<br>186 Veterans Drive,<br>Northvale, NJ 07647<br>Tel. (201) 784-1000<br>Fax (201) 784-0111 | Drawing Title: GT-86060-0605-W2E, ITE Power Supply, Efficiency Level: VI, Case Color/Style: GlobTek Black, Wall Plug-in, Regulated Switchmode AC-DC Power Supply AC Adaptor, Input Rating: 100-240V~, 50/60Hz, Euro Plug Fixed , Output Rating: 6W, 5V@1.2A, Output Configuration: 1500 mm, 22/2 Cond, UL 2468, Micro USB type B without resistor, Ferrite: None, GlobTek Black, GT Cord # C7727, Pin Out: Pin 1: +V, Pin 2-4: N/C, Pin 5: GND, Blades/Input Cord: Fixed Blades European 7/7 2 Conductor, Approvals: Ukraine; LPS; China RoHS; RoHS; CE; PSE; CB 60950; Double Insulation; VCCI; WEEE; EAC; SGS; |       |
|   | Model No. GT-86060-0605-W2E  |       |
|   | Part No./Ordering No. WR9MA1200MICB-F(R6B)   | Rev C |

## ELECTRICAL SPECIFICATIONS

### A) ELECTRICAL SPECIFICATIONS:

01. Input Voltage: Specified 90-264 Vac, Nameplate rated: 100-240Vac
02. Input Frequency: Specified 47-63 Hz, Nameplate rated 50-60Hz
03. Output Regulation: +/- 5%
04. Ripple and Noise (Vp-p): 250 mVp-p maximum, At 20 MHz, and output parallel with 0.1uF & 47uF capacitors to ground. Temperature at 25 °C, and nominal input voltage
05. Efficiency: Compliant with Efficiency Level VI and ErP European Commission's Ecodesign Directive (2005/32/EC) / CoC Tier 2 Compliant
06. No Load Standby Power: <0.075W @ 230Vac
07. Turn-ON Delay: 3 Seconds maximum at nominal input voltage
08. Rise Time: 100mS maximum at nominal input voltage

### B) PROTECTION

01. Over-Voltage
02. Over current protection
03. Short Circuit: Short circuit protection is to be included in the construction of the adaptor. The adaptor is designed to withstand continuous current of a short circuit on the output. The adaptor will be short circuit tolerant for an indefinite period.

### C) SAFETY

01. Dielectric Withstand Voltage: Primary To Secondary: 3000VAC 10mA 1minute or 4242VDC 10mA 1minute
02. Touch Current: Did not exceed 100uA NC(Normal condition) 500uA SFC(single fault condition)

### D) EMC

01. Emissions, per EN 55032, EN 61000-6-3, EN 61000-6-4
  - Conducted Emissions: Class B, FCC Part 15, Class B
  - Radiated Emissions: Class B, FCC Part 15, Class B
02. Line Frequency Harmonics EN61000-3-2, Class A
03. Voltage Fluctuations/Flicker EN61000-3-3
04. Immunity, per EN 55024, EN 61000-6-1, EN 61000-6-2
  - Static Discharge Immunity EN61000-4-2, 4kV Contact Discharge, 8kV air discharge
  - Radiated RF Immunity EN61000-4-3, 3V/m 80-1000MHz, 80% 1KHz AM.
  - EFT/Burst Immunity EN61000-4-4, 1kV/100kHz.
  - Line Surge Immunity EN61000-4-5, 1kV differential, 2kV common-mode
  - Conducted RF Immunity EN61000-4-6, 3Vrms, 80% 1KHz AM
  - Power Frequency Magnetic Field Immunity EN61000-4-8, 1A/m
  - Voltage Dip Immunity EN61000-4-11, Criteria

### E) OTHER:

01. MTBF: 200,000 Hours @ 25°C ambient temperature
02. Operating Temperature: 0°C to 40°C ambient temperature
03. Humidity: 0% to 90% relative humidity
04. Storage Temperature: -10°C to 80°C
05. Cooling: natural convection cooling
06. ROHS 2: Complies with EU 2011/65/EU and China SJ/T 11363-2006

#### PROPRIETARY INFORMATION

PROPRIETARY OF GLOBTEK, INC. ANY REPRODUCTION, DISCLOSURE OR USE OF THIS DRAWING, IN WHOLE OR IN PART, IS HEREBY PROHIBITED EXCEPT AS SPECIFIED IN WRITING BY GLOBTEK, INC. © GlobTek, Inc. 2017 - 2019

GlobTek, Inc.  
 www.globtek.com  
 186 Veterans Drive,  
 Northvale, NJ 07647  
 Tel. (201) 784-1000  
 Fax (201) 784-0111

Drawing Title: GT-86060-0605-W2E, ITE Power Supply, Efficiency Level: VI, Case Color/Style: GlobTek Black, Wall Plug-in, Regulated Switchmode AC-DC Power Supply AC Adaptor, Input Rating: 100-240V~, 50/60Hz, Euro Plug Fixed, Output Rating: 6W, 5V@1.2A, Output Configuration: 1500 mm, 22/2 Cond, UL 2468, Micro USB type B without resistor, Ferrite: None, GlobTek Black, GT Cord # C7727, Pin Out: Pin 1: +V, Pin 2-4: N/C, Pin 5: GND, Blades/Input Cord: Fixed Blades European 7/7 2 Conductor, Approvals: Ukraine; LPS; China RoHS; RoHS; CE; PSE; CB 60950; Double Insulation; VCCI; WEEE; EAC; SGS;

Model No. GT-86060-0605-W2E

Part No./Ordering No. WR9MA1200MICB-F(R6B)

Rev C

F) ENCLOSURE

- 01. Housing: High impact plastic, 94V0 polycarbonate, non-vented
- 02. Markings: Label and/or Pad Printed and/or Molded in the case

INGRESS PROTECTION: IPX0

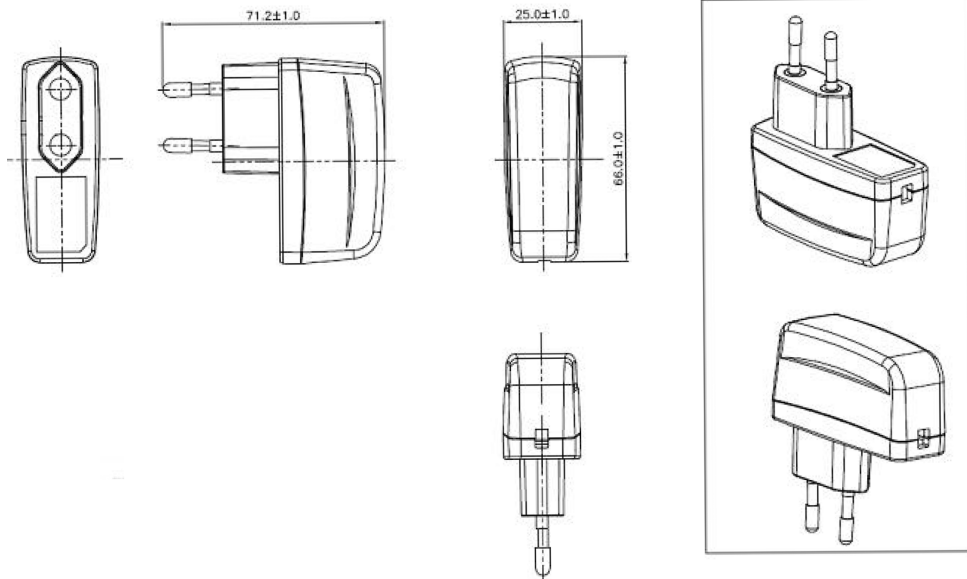

DERATING CURVE

GlobTek, Inc.  
 www.globtek.com  
 186 Veterans Drive,  
 Northvale, NJ 07647  
 Tel. (201) 784-1000  
 Fax (201) 784-0111

Drawing Title: GT-86060-0605-W2E, ITE Power Supply, Efficiency Level: VI, Case Color/Style: GlobTek Black, Wall Plug-in, Regulated Switchmode AC-DC Power Supply AC Adaptor, Input Rating: 100-240V~, 50/60Hz, Euro Plug Fixed , Output Rating: 6W, 5V@1.2A, Output Configuration: 1500 mm, 22/2 Cond, UL 2468, Micro USB type B without resistor, Ferrite: None, GlobTek Black, GT Cord # C7727, Pin Out: Pin 1: +V, Pin 2-4: N/C, Pin 5: GND, Blades/Input Cord: Fixed Blades European 7/7 2 Conductor, Approvals: Ukraine; LPS; China RoHS; RoHS; CE; PSE; CB 60950; Double Insulation; VCCI; WEEE; EAC; SGS;

Model No. GT-86060-0605-W2E

Part No./Ordering No. WR9MA1200MICB-F(R6B)

Rev C

### Typical External Power Supply Derating Curve

(For Efficiency Level V and Efficiency Level VI Products)

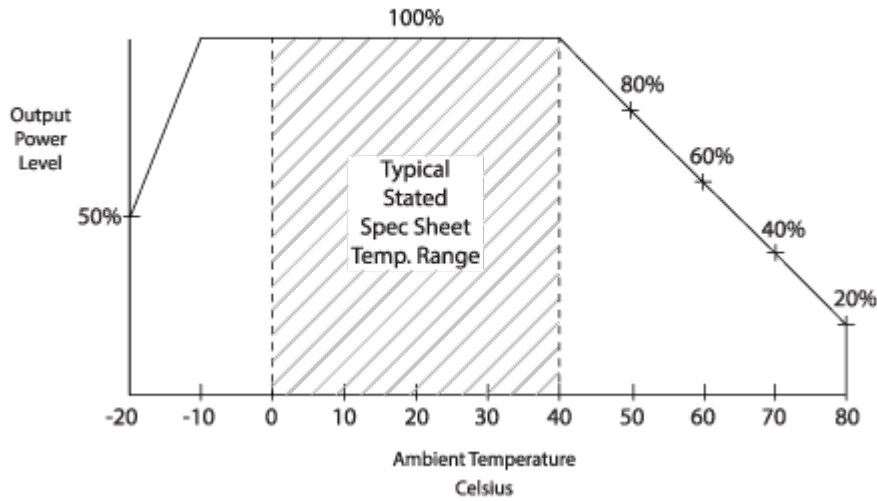

GlobTek, Inc.  
 www.globtek.com  
 186 Veterans Drive,  
 Northvale, NJ 07647  
 Tel. (201) 784-1000  
 Fax (201) 784-0111

Drawing Title: GT-86060-0605-W2E, ITE Power Supply, Efficiency Level: VI, Case Color/Style: GlobTek Black, Wall Plug-in, Regulated Switchmode AC-DC Power Supply AC Adaptor, Input Rating: 100-240V~, 50/60Hz, Euro Plug Fixed , Output Rating: 6W, 5V@1.2A, Output Configuration: 1500 mm, 22/2 Cond, UL 2468, Micro USB type B without resistor, Ferrite: None, GlobTek Black, GT Cord # C7727, Pin Out: Pin 1: +V, Pin 2-4: N/C, Pin 5: GND, Blades/Input Cord: Fixed Blades European 7/7 2 Conductor, Approvals: Ukraine; LPS; China RoHS; RoHS; CE; PSE; CB 60950; Double Insulation; VCCI; WEEE; EAC; SGS;

Model No. GT-86060-0605-W2E

Part No./Ordering No. WR9MA1200MICB-F(R6B)

Rev C

## INPUT CONFIGURATION

(F1) Class II / Double Insulated

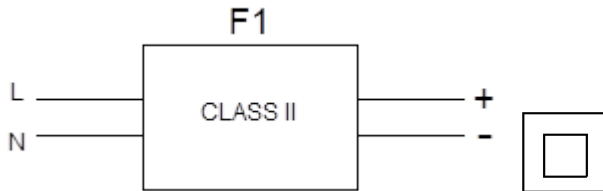

[Alternate grounding configurations](#) available upon request.

Blades/Cord Included: FBEuro2:

Blades/Cord Installed: FBEuro2:

European CEE 7/16 configuration: Europlug 2 PIN

The prongs of the Europlug are 19 mm long. They consist of a 9 mm long conductive tip of 4 mm diameter with a rounded ending, followed by a 10 mm long flexible insulated shaft of not more than 3.8 mm diameter. The two prongs are not exactly parallel and converge slightly; their centres are 19 mm apart at the tip and 18.6 mm apart at the base. The elasticity of the converging prongs provides sufficient contact force for the Europlug's current rating with a variety of socket-hole arrangements. The entire plug is 35.3 mm wide and 13.7 mm high, and must not exceed these dimensions within 18 mm behind its front plane (this allows for the recesses on many European socket types). The left and right side of the plug are formed by surfaces that are at 45° relative to the horizontal plan.

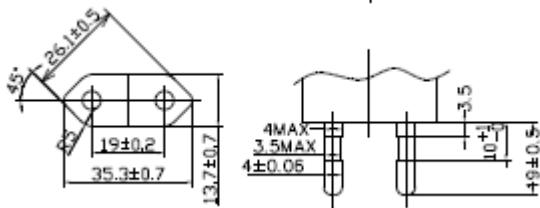

|   |  |       |
|---|--|-------|
| GlobTek, Inc.<br>www.globtek.com<br>186 Veterans Drive,<br>Northvale, NJ 07647<br>Tel. (201) 784-1000<br>Fax (201) 784-0111 | Drawing Title: GT-86060-0605-W2E, ITE Power Supply, Efficiency Level: VI, Case Color/Style: GlobTek Black, Wall Plug-in, Regulated Switchmode AC-DC Power Supply AC Adaptor, Input Rating: 100-240V~, 50/60Hz, Euro Plug Fixed , Output Rating: 6W, 5V@1.2A, Output Configuration: 1500 mm, 22/2 Cond, UL 2468, Micro USB type B without resistor, Ferrite: None, GlobTek Black, GT Cord # C7727, Pin Out: Pin 1: +V, Pin 2-4: N/C, Pin 5: GND, Blades/Input Cord: Fixed Blades European 7/7 2 Conductor, Approvals: Ukraine; LPS; China RoHS; RoHS; CE; PSE; CB 60950; Double Insulation; VCCI; WEEE; EAC; SGS; |       |
|   | Model No. GT-86060-0605-W2E  |       |
|   | Part No./Ordering No. WR9MA1200MICB-F(R6B)   | Rev C |

**OUTPUTCORD AND CONNECTOR: MICUSB/C7727**

ACTUAL CONNECTORS, OVERMOLDS, FERRITES MAY VARY SLIGHTLY FROM THE PICTURE BELOW

|  |                                     |
|--|-------------------------------------|
| CABLE TYPE                                       | UL 2468                             |
| CABLE LENGTH&#160;(mm)                           | 1500                                |
| CABLE TOLERANCE&#160;(mm)                        | +150 -0                             |
| WIRE GAUGE (AWG)                                 | 22                                  |
| CONDUCTORS                                       | 2                                   |
| HANK DIMENSION (mm)                              | 80mm +/-10                          |
| CABLE / CONNECTOR OVERMOLD COLOR                 | GlobTek Black                       |
| FERRITE TYPE / DIMENSION                         | None                                |
| FERRITE # OF TURNS( <a href="#">Definition</a> ) | N/A                                 |
| FERRITE DIMENSION FROM STRAIN RELIEF             | N/A                                 |
| FERRITE DIMENSION FROM PLUG                      | N/A                                 |
| PLUG TYPE  | Micro USB type B without resistor   |
| OUTPUT CONNECTOR SEX                             |                                     |
| OVERMOLDED                                       |                                     |
| OVER MOLD ORIENTATION                            | Straight                            |
| CONNECTOR PIN OUT:                               | Pin 1: +V, Pin 2-4: N/C, Pin 5: GND |
| ADDITIONAL REQUIREMENTS                          |                                     |

**PINOUT:**

- PIN 1: +5V
- PIN 2: N/C
- PIN 3: N/C
- PIN 4: N/C
- PIN 5: GND

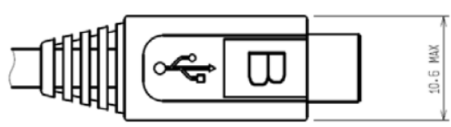
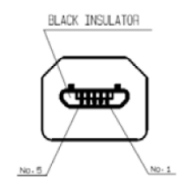
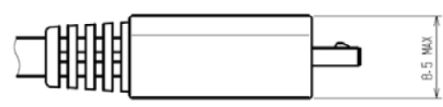

ADDITIONAL OUTPUT PLUG OPTIONS ARE AVAILABLE AT <https://www.globtek.com/connectors/>  
STANDARD PLUGS AND CONNECTORS CAN BE SEEN ONLINE AT <https://www.globtek.com/connectors/>

|   |  |       |
|---|--|-------|
| GlobTek, Inc.<br>www.globtek.com<br>186 Veterans Drive,<br>Northvale, NJ 07647<br>Tel. (201) 784-1000<br>Fax (201) 784-0111 | Drawing Title: GT-86060-0605-W2E, ITE Power Supply, Efficiency Level: VI, Case Color/Style: GlobTek Black, Wall Plug-in, Regulated Switchmode AC-DC Power Supply AC Adaptor, Input Rating: 100-240V~, 50/60Hz, Euro Plug Fixed , Output Rating: 6W, 5V@1.2A, Output Configuration: 1500 mm, 22/2 Cond, UL 2468, Micro USB type B without resistor, Ferrite: None, GlobTek Black, GT Cord # C7727, Pin Out: Pin 1: +V, Pin 2-4: N/C, Pin 5: GND, Blades/Input Cord: Fixed Blades European 7/7 2 Conductor, Approvals: Ukraine; LPS; China RoHS; RoHS; CE; PSE; CB 60950; Double Insulation; VCCI; WEEE; EAC; SGS; |       |
|   | Model No. GT-86060-0605-W2E  |       |
|   | Part No./Ordering No. WR9MA1200MICB-F(R6B)   | Rev C |

LABEL:L-1186

LABEL P/N: Standard GT  
MATERIAL: Flat Thermal Transfer, Imprintable, Polyester Label and/or Pad Printed and/or Molded, and/or Laser Engraved in the case  
BACKGROUND COLOR: Black if housing is Black, White or Silver if housing is White or Gray.  
TEXT COLOR: White or Silver if label is Black Background for Black housing. Black if label is White or Silver background and Housing is White or Gray  
LABEL WIDTH (mm): 16  
LABEL HEIGHT (mm): 24  
SPECIAL BARCODE LABEL: No  
MATERIAL: No

Below is the minimum information which will appear on the label. NOTE: in the logo area additional/actual positioning of symbols and text is subjected to change as per agency updates/requirements or additional model approvals become available.  
Regulatory certifications/label markings may be in logo area on the label or molded into the case housing outside the label area.  
Information will be shown via label and/or pad printed and/or molded and/or laser engraved in the case. \* Date code markings at GlobTek option.



A=ITE Power Supply  
B=P/N: (料号) WR9MA1200MICB-F(R6B)  
C=Model (型号) GT-86060-0605-W2E  
D=Input (输入) 100-240V~, 50/60Hz, 0.2A  
E=Output (输出) 5 V 1.2 A, 6.0W

AGENCY ONLINE DOCUMENTS <http://www.globtek.info/certs/GT-86060-WVVV-W2Z/>  
CE EC-Declaration for Medical [Contact GlobTek for more information](#)



|   |  |       |
|---|--|-------|
| GlobTek, Inc.<br>www.globtek.com<br>186 Veterans Drive,<br>Northvale, NJ 07647<br>Tel. (201) 784-1000<br>Fax (201) 784-0111 | Drawing Title: GT-86060-0605-W2E, ITE Power Supply, Efficiency Level: VI, Case Color/Style: GlobTek Black, Wall Plug-in, Regulated Switchmode AC-DC Power Supply AC Adaptor, Input Rating: 100-240V~, 50/60Hz, Euro Plug Fixed , Output Rating: 6W, 5V@1.2A, Output Configuration: 1500 mm, 22/2 Cond, UL 2468, Micro USB type B without resistor, Ferrite: None, GlobTek Black, GT Cord # C7727, Pin Out: Pin 1: +V, Pin 2-4: N/C, Pin 5: GND, Blades/Input Cord: Fixed Blades European 7/7 2 Conductor, Approvals: Ukraine; LPS; China RoHS; RoHS; CE; PSE; CB 60950; Double Insulation; VCCI; WEEE; EAC; SGS; |       |
|   | Model No. GT-86060-0605-W2E  |       |
|   | Part No./Ordering No. WR9MA1200MICB-F(R6B)   | Rev C |

CE EC-Declaration for Industrial/Commercial/ITE [http://globtek.force.com/models/ec\\_declaration?id=a0Oa000000MmdtPEAR](http://globtek.force.com/models/ec_declaration?id=a0Oa000000MmdtPEAR)  
CE EC-Declaration for Household [Contact GlobTek for more information](http://globtek.force.com/models/ec_declaration?id=a0Oa000000MmdtPEAR)  
RoHS/RoHS3 Declaration [https://www.globtek.com/pdf/rohs\\_cert/01ta0000007dRI4AAM](https://www.globtek.com/pdf/rohs_cert/01ta0000007dRI4AAM)  
REACH Declaration [https://www.globtek.com/pdf/iso\\_certificates/REACH.pdf](https://www.globtek.com/pdf/iso_certificates/REACH.pdf)  
Conflict Minerals Declaration <https://www.globtek.com/pdf/conflict-minerals.pdf>  
IPXY rating is based on 3rd party testing and customers should check suitability and test system level IPXY rating before ordering.

## Regulatory Certifications/Label Markings

LATEST PRODUCT/MODEL CERTIFICATIONS: <http://en.globtek.com/datasheet/id/a0Oa000000MmdtP>  
AGENCY ONLINE DOCUMENTS: <http://www.globtek.info/certs/GT-86060-WVVV-WZZ/>



(F1) Class II / Double Insulated

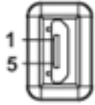

Pin 1: +V, Pin 2-4: N/C, Pin 5: GND

|   |  |       |
|---|--|-------|
| GlobTek, Inc.<br>www.globtek.com<br>186 Veterans Drive,<br>Northvale, NJ 07647<br>Tel. (201) 784-1000<br>Fax (201) 784-0111 | Drawing Title: GT-86060-0605-W2E, ITE Power Supply, Efficiency Level: VI, Case Color/Style: GlobTek Black, Wall Plug-in, Regulated Switchmode AC-DC Power Supply AC Adaptor, Input Rating: 100-240V~, 50/60Hz, Euro Plug Fixed , Output Rating: 6W, 5V@1.2A, Output Configuration: 1500 mm, 22/2 Cond, UL 2468, Micro USB type B without resistor, Ferrite: None, GlobTek Black, GT Cord # C7727, Pin Out: Pin 1: +V, Pin 2-4: N/C, Pin 5: GND, Blades/Input Cord: Fixed Blades European 7/7 2 Conductor, Approvals: Ukraine; LPS; China RoHS; RoHS; CE; PSE; CB 60950; Double Insulation; VCCI; WEEE; EAC; SGS; |       |
|   | Model No. GT-86060-0605-W2E  |       |
|   | Part No./Ordering No. WR9MA1200MICB-F(R6B)   | Rev C |

## PACKAGING

|   |   |
|---|---|
| Packing Spec P/N:                             | Standard WPI non changeable, Individually Box, User manual  |
| Box Qty:                                      | 120   |
| Gift Box Size (mm):                           | 75*85*51  |
| Gift Box Color:                               | White   |
| Master Carton Size (mm):                      | 445 x 326 x 335   |
| Master Carton Cubic Volume (m <sup>3</sup> ): | 0.05  |
| Master GW (Kg):                               | 15.6 kg   |
| BLADES INCLUDED:                              | FBEuro2:  |
| BLADE/CORD INSTALLED:                         | FBEuro2:  |
| USER MANUAL:                                  | 809-DESKTOPUSERMANUAL   |
| USER MANUAL WEB LINK:                         | <a href="https://en.globtek.com/pdf/809-DESKTOPUSERMANUA...">https://en.globtek.com/pdf/809-DESKTOPUSERMANUA...</a> |

If specific packaging is required, this section must specify all requirements and note "no exceptions". If this section does not specify packaging, it is subject to change without notice at GlobTek's discretion

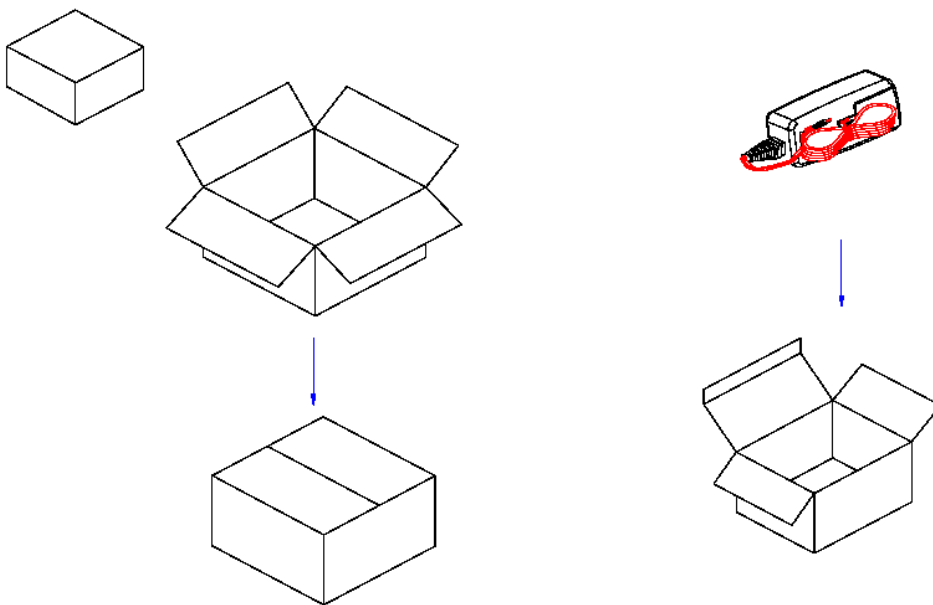

### PROPRIETARY INFORMATION

|   |  |       |
|---|--|-------|
| GlobTek, Inc.<br>www.globtek.com<br>186 Veterans Drive,<br>Northvale, NJ 07647<br>Tel. (201) 784-1000<br>Fax (201) 784-0111 | Drawing Title: GT-86060-0605-W2E, ITE Power Supply, Efficiency Level: VI, Case Color/Style: GlobTek Black, Wall Plug-in, Regulated Switchmode AC-DC Power Supply AC Adaptor, Input Rating: 100-240V~, 50/60Hz, Euro Plug Fixed , Output Rating: 6W, 5V@1.2A, Output Configuration: 1500 mm, 22/2 Cond, UL 2468, Micro USB type B without resistor, Ferrite: None, GlobTek Black, GT Cord # C7727, Pin Out: Pin 1: +V, Pin 2-4: N/C, Pin 5: GND, Blades/Input Cord: Fixed Blades European 7/7 2 Conductor, Approvals: Ukraine; LPS; China RoHS; RoHS; CE; PSE; CB 60950; Double Insulation; VCCI; WEEE; EAC; SGS; |       |
|   | Model No. GT-86060-0605-W2E  |       |
|   | Part No./Ordering No. WR9MA1200MICB-F(R6B)   | Rev C |

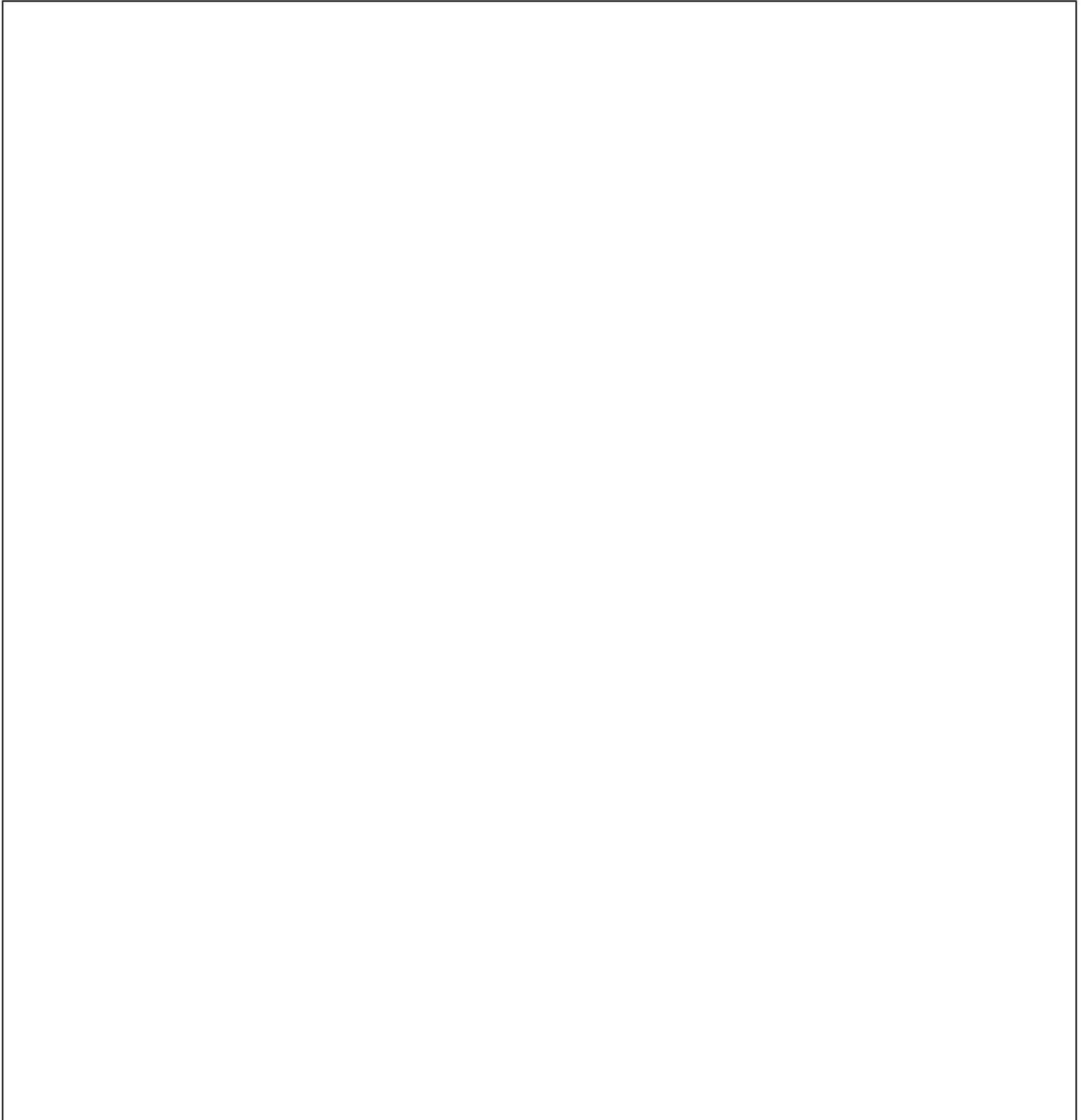

|   |  |       |
|---|--|-------|
| GlobTek, Inc.<br>www.globtek.com<br>186 Veterans Drive,<br>Northvale, NJ 07647<br>Tel. (201) 784-1000<br>Fax (201) 784-0111 | Drawing Title: GT-86060-0605-W2E, ITE Power Supply, Efficiency Level: VI, Case Color/Style: GlobTek Black, Wall Plug-in, Regulated Switchmode AC-DC Power Supply AC Adaptor, Input Rating: 100-240V~, 50/60Hz, Euro Plug Fixed , Output Rating: 6W, 5V@1.2A, Output Configuration: 1500 mm, 22/2 Cond, UL 2468, Micro USB type B without resistor, Ferrite: None, GlobTek Black, GT Cord # C7727, Pin Out: Pin 1: +V, Pin 2-4: N/C, Pin 5: GND, Blades/Input Cord: Fixed Blades European 7/7 2 Conductor, Approvals: Ukraine; LPS; China RoHS; RoHS; CE; PSE; CB 60950; Double Insulation; VCCI; WEEE; EAC; SGS; |       |
|   | Model No. GT-86060-0605-W2E  |       |
|   | Part No./Ordering No. WR9MA1200MICB-F(R6B)   | Rev C |

## INSTRUCTIONS TO THE OEM SYSTEMS ENGINEER

It is the responsibility of the OEM systems engineer to provide the end system user instructions and warnings for the use of this product in the end system.

If an input cord is required for this product, AC Mains voltage should be provided to the power supply by a power supply cord approved to the national standards of the country in which it will be used.

This power supply is not designed to be repaired. No serviceable parts inside. A blown internal fuse is an indication of catastrophic failure of circuit component(s). If a Failure Analysis is required for a failed power supply/battery charger, please return the damaged unit to Globtek for an accurate determination of the root cause of the failure.

EMC Compliance of the complete OEM product, including the GlobTek power supply/battery charger needs to be verified by the OEM systems engineer.

## INSTRUCTION SHEET

N/A