

GlobTek, Inc. www.globtek.com 186 Veterans Drive, Northvale, NJ 07647 Tel. (201) 784-1000 Fax (201) 784-0111	Drawing Title: GT-86120-1005-W2U, ITE Power Supply, Efficiency Level: VI, Case Color/Style: GlobTek Black, Wall Plug-in, Regulated Switchmode AC-DC Power Supply AC Adaptor, Input Rating: 100-240V- , 50/60Hz, British Fixed , Output Rating: 10W, 5V@2A, Output Configuration: 1530 mm, 20/2 Cond, UL 2468, Female Barrel 5.5 * 2.5 * 11mm with internal Spring Clip and Locking Notch or Equal, Ferrite: None, GlobTek Black, GT Cord # C3262, Pin Out: Center Positive (+V), Blades/Input Cord: Fixed Blades UK, Approvals: WEEE; EAC; CB 60950; CE; China RoHS; cULus; Double Insulation; VCCI; Ukraine; SGS (GS); RoHS; PSE; LPS; Level VI; PSE;	
	Model No. GT-86120-1005-W2U	
	Part No./Ordering No. WR95A2000LCP-F(R6B)	Rev A1

## REVISION HISTORY

REV	DESCRIPTION	SUB	DATE	APPROVED
A1	Update Ukraine No.	rchiu	11/17/2017	QA
A	Initial Release	jwarrn	05/02/2017	QA

In Addition to GlobTek Inc.'s renewed ISO9001:2015 - Quality Management System Certification, GlobTek Inc. is now certified to:

ISO13485:2016 - Medical Devices Quality Management System Certification

ISO14001:2015 - Environmental Management System Certification

ISO Certificates are available online at <https://www.globtek.com/iso-certificates/>

### Customer Approval of Specification:

Please approve, sign and send back to GlobTek so we can complete order processing.

A delay in receipt of this form will delay delivery schedule.

Company Name:

Customer P/N:

Quote Number:

Date:

Authorized Representative Name:

Authorized Representative Signature:

The acceptance of this specification and use of the product described in this document indicates the acceptance and binding of the customer to Globtek terms and conditions, which supersede all other agreements, terms, and conditions (<https://en.globtek.com/terms-and-conditions/>).

### Footnote:

GlobTek Inc. will not be liable for the safety and performance of these power supplies if unauthorized access and repair occurs. End user should consult applicable UL, CSA or EN standards for proper installation instruction.

### Limitation of Use:

GlobTek products are intended for use with commercial, medical, and/or industrial equipment only. GlobTek product are not authorized for use as mission critical components in life support hazardous environment, nuclear or aircraft applications without prior written approval from the CEO of GlobTek Inc.

Contents of this document are subject to change without prior notice.

GlobTek, Inc. www.globtek.com 186 Veterans Drive, Northvale, NJ 07647 Tel. (201) 784-1000 Fax (201) 784-0111	Drawing Title: GT-86120-1005-W2U, ITE Power Supply, Efficiency Level: VI, Case Color/Style: GlobTek Black, Wall Plug-in, Regulated Switchmode AC-DC Power Supply AC Adaptor, Input Rating: 100-240V- , 50/60Hz, British Fixed , Output Rating: 10W, 5V@2A, Output Configuration: 1530 mm, 20/2 Cond, UL 2468, Female Barrel 5.5 * 2.5 * 11mm with internal Spring Clip and Locking Notch or Equal, Ferrite: None, GlobTek Black, GT Cord # C3262, Pin Out: Center Positive (+V), Blades/Input Cord: Fixed Blades UK, Approvals: WEEE; EAC; CB 60950; CE; China RoHS; cULus; Double Insulation; VCCI; Ukraine; SGS (GS); RoHS; PSE; LPS; Level VI; PSE;	
	Model No. GT-86120-1005-W2U	
	Part No./Ordering No. WR95A2000LCP-F(R6B)	Rev A1

## POWER SUPPLY INFORMATION

TYPE: Wall Plug-in  
TECHNOLOGY: Regulated Switchmode AC-DC Power Supply AC Adaptor  
CASE COLOR: GlobTek Black  
NAMEPLATE RATED INPUT: 100-240V- , 50/60Hz, 0.5A  
INPUT CONFIG: British Fixed  
WATTS: 10.0  
VOLTS OUT: 5  
CURRENT OUT (Amps): 2  
BLADE/CORD INCLUDED: FBUK2  
BLADE/CORD INSTALLED: FBUK2  
INGRESS PROTECTION: IPX0  
GROUNDING CONFIGURATION: (F1) Class II / Double Insulated  
EFFICIENCY LEVEL: VI  
OUTPUT CONFIGURATION: 1530 mm, 20/2 Cond, UL 2468, Female Barrel 5.5 \* 2.5 \* 11mm with internal Spring Clip and Locking Notch or Equal, Ferrite: None, GlobTek Black, GT Cord # C3262  
CONNECTOR PIN OUT: Center Positive (+V)  
LABEL SPECS: Standard GT,L-1186  
SPECIAL BARCODE LABEL  
MATERIAL:  
PACK SPEC: Standard WPI non changeable, Individually Box, User manual  
USER MANUAL: 809-DESKTOPUSERMANUAL on A4 paper

Notes/Modifications/Customizations (notes in this section supersede the values shown in the standard spec):

DIMENSIONS ARE IN MM UNLESS SPECIFIED OTHERWISE.

GlobTek, Inc. www.globtek.com 186 Veterans Drive, Northvale, NJ 07647 Tel. (201) 784-1000 Fax (201) 784-0111	Drawing Title: GT-86120-1005-W2U, ITE Power Supply, Efficiency Level: VI, Case Color/Style: GlobTek Black, Wall Plug-in, Regulated Switchmode AC-DC Power Supply AC Adaptor, Input Rating: 100-240V , 50/60Hz, British Fixed , Output Rating: 10W, 5V@2A, Output Configuration: 1530 mm, 20/2 Cond, UL 2468, Female Barrel 5.5 * 2.5 * 11mm with internal Spring Clip and Locking Notch or Equal, Ferrite: None, GlobTek Black, GT Cord # C3262, Pin Out: Center Positive (+V), Blades/Input Cord: Fixed Blades UK, Approvals: WEEE; EAC; CB 60950; CE; China RoHS; cULus; Double Insulation; VCCI; Ukraine; SGS (GS); RoHS; PSE; LPS; Level VI; PSE;	
	Model No. GT-86120-1005-W2U	
	Part No./Ordering No. WR95A2000LCP-F(R6B)	Rev A1

## ELECTRICAL SPECIFICATIONS

### ELECTRICAL SPECIFICATIONS:

01. Input Voltage: Specified 90-264 Vac, Nameplate rated: 100-240Vac
02. Input Frequency: Specified 47-63 Hz, Nameplate rated 50-60Hz
03. Output Regulation: +/- 5%
04. Ripple and Noise (Vp-p): 100 mVp-p maximum, At 20 MHz, and output parallel with 0.1uF & 47uF capacitors to ground. Temperature at 25 °C, and nominal input voltage
05. Efficiency: Compliant with Efficiency Level VI and ErP European Commission's Ecodesign Directive (2005/32/EC) / CoC Tier 2 Compliant
06. No Load Standby Power: <0.075W @ 230Vac
07. Turn-ON Delay: 3 Seconds maximum at nominal input voltage
08. Rise Time: 100mS maximum at nominal input voltage

### B) PROTECTION

01. Over-Voltage: 10VDC maximum
02. Over current protection: 4A maximum with auto-recovery function
03. Short Circuit: Short circuit protection is to be included in the construction of the adaptor. The adaptor is designed to withstand continuous current of a short circuit on the output. The adaptor will be short circuit tolerant for an indefinite period.

### C) SAFETY

01. Dielectric Withstand Voltage: 3000VAC 10mA 1minute or 4242VDC 10mA 1minute from primary to secondary
02. Leakage current: 0.25mA maximum, at nominal AC input voltage and frequency
03. Static Discharge Immunity of 8kV Contact Discharge, 15kV air discharge.

### D) EMC

01. Emissions, per EN 55032, EN 61000-6-3, EN 61000-6-4
  - Conducted Emissions: Class B, FCC Part 15, Class B
  - Radiated Emissions: Class B, FCC Part 15, Class B
02. Line Frequency Harmonics EN61000-3-2, Class A
03. Voltage Fluctuations/Flicker EN61000-3-3
04. Immunity, per EN 55024, EN 61000-6-1, EN 61000-6-2
  - Static Discharge Immunity EN61000-4-2, 4kV Contact Discharge, 8kV air discharge
  - Radiated RF Immunity EN61000-4-3, 3V/m 80-1000MHz, 80% 1KHz AM.
  - EFT/Burst Immunity EN61000-4-4, 1kV/100kHz.
  - Line Surge Immunity EN61000-4-5, 1kV differential, 2kV common-mode
  - Conducted RF Immunity EN61000-4-6, 3Vrms, 80% 1KHz AM
  - Power Frequency Magnetic Field Immunity EN61000-4-8, 1A/m
  - Voltage Dip Immunity EN61000-4-11, Criteria

### E) OTHER:

01. MTBF: 200,000 Hours @ 25°C ambient temperature
02. Operating Temperature: 0°C to 50°C ambient temperature (RFP7139)
03. Humidity: 5% to 90% relative humidity
04. Storage Temperature: -20°C to 60°C
05. Cooling: natural convection cooling
06. ROHS 2: Complies with EU 2011/65/EU and China SJ/T 11363-2006

### F) ENCLOSURE

#### PROPRIETARY INFORMATION

PROPRIETARY OF GLOBTEK, INC. ANY REPRODUCTION, DISCLOSURE OR USE OF THIS DRAWING, IN WHOLE OR IN PART, IS HEREBY PROHIBITED EXCEPT AS SPECIFIED IN

WRITING BY GLOBTEK, INC. © GlobTek, Inc. 2017 - 2019

quest /09/19/2019 11:17:05 PM

<p>GlobTek, Inc.  www.globtek.com  186 Veterans Drive,  Northvale, NJ 07647  Tel. (201) 784-1000  Fax (201) 784-0111</p>	<p>Drawing Title: GT-86120-1005-W2U, ITE Power Supply, Efficiency Level: VI, Case Color/Style: GlobTek Black, Wall Plug-in, Regulated Switchmode AC-DC Power Supply AC Adaptor, Input Rating: 100-240V- , 50/60Hz, British Fixed , Output Rating: 10W, 5V@2A, Output Configuration: 1530 mm, 20/2 Cond, UL 2468, Female Barrel 5.5 * 2.5 * 11mm with internal Spring Clip and Locking Notch or Equal, Ferrite: None, GlobTek Black, GT Cord # C3262, Pin Out: Center Positive (+V), Blades/Input Cord: Fixed Blades UK, Approvals: WEEE; EAC; CB 60950; CE; China RoHS; cULus; Double Insulation; VCCI; Ukraine; SGS (GS); RoHS; PSE; LPS; Level VI; PSE;</p>
<p>Model No. GT-86120-1005-W2U</p>	
<p>Part No./Ordering No. WR95A2000LCP-F(R6B)</p>	<p>Rev A1</p>

- 01. Housing: High impact plastic, 94V0 polycarbonate, non-vented
- 02. Markings: Label and/or Pad Printed and/or Molded in the case

INGRESS PROTECTION: IPX0

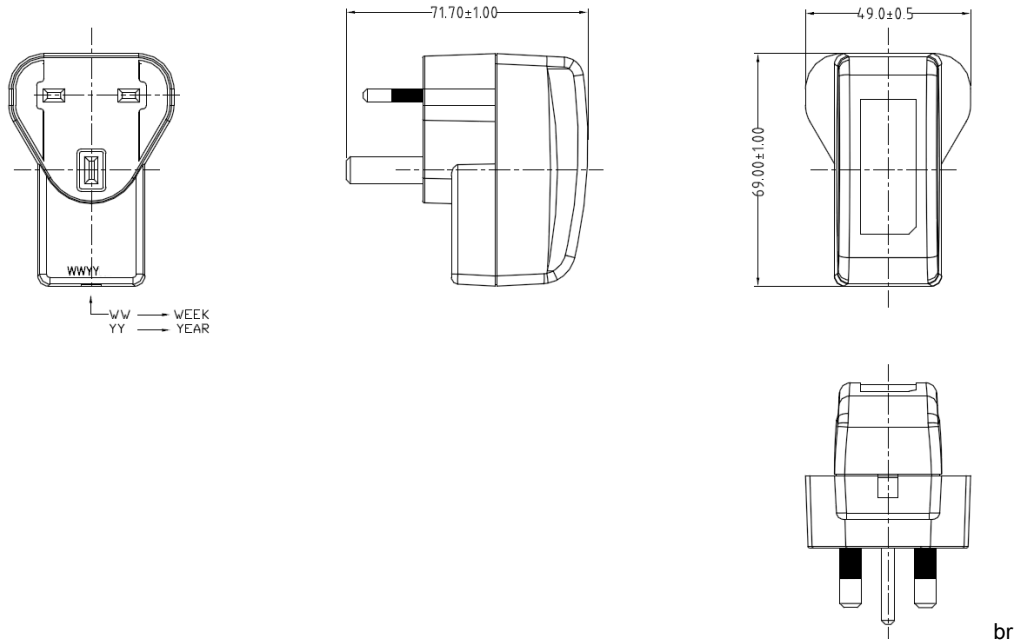

DERATING CURVE

<p>GlobTek, Inc.  www.globtek.com  186 Veterans Drive,  Northvale, NJ 07647  Tel. (201) 784-1000  Fax (201) 784-0111</p>	<p>Drawing Title: GT-86120-1005-W2U, ITE Power Supply, Efficiency Level: VI, Case Color/Style: GlobTek Black, Wall Plug-in, Regulated Switchmode AC-DC Power Supply AC Adaptor, Input Rating: 100-240V- , 50/60Hz, British Fixed , Output Rating: 10W, 5V@2A, Output Configuration: 1530 mm, 20/2 Cond, UL 2468, Female Barrel 5.5 * 2.5 * 11mm with internal Spring Clip and Locking Notch or Equal, Ferrite: None, GlobTek Black, GT Cord # C3262, Pin Out: Center Positive (+V), Blades/Input Cord: Fixed Blades UK, Approvals: WEEE; EAC; CB 60950; CE; China RoHS; cULus; Double Insulation; VCCI; Ukraine; SGS (GS); RoHS; PSE; LPS; Level VI; PSE;</p>
	<p>Model No. GT-86120-1005-W2U</p>
	<p>Part No./Ordering No. WR95A2000LCP-F(R6B) <span style="float: right;">Rev A1</span></p>

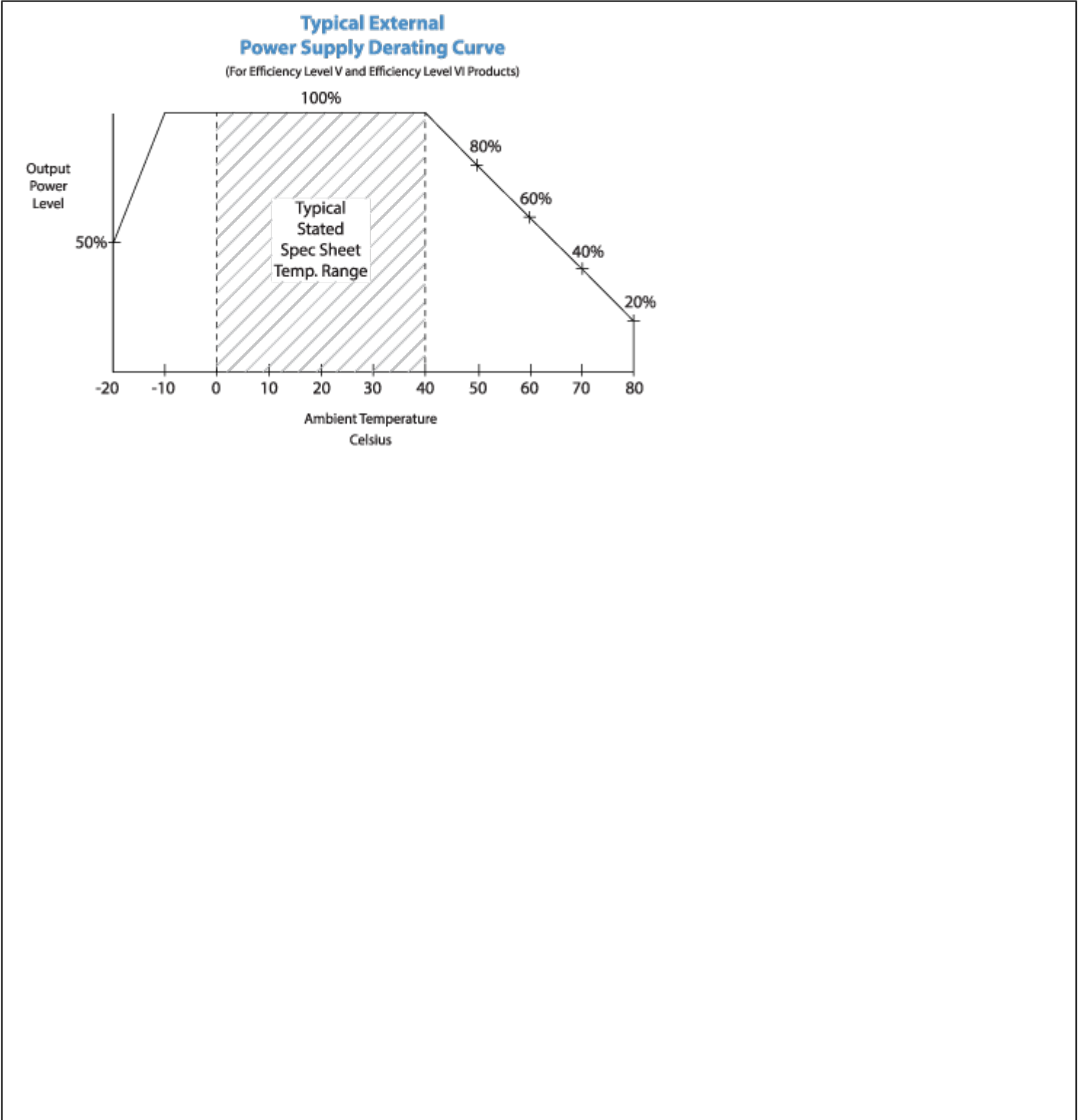

GlobTek, Inc. www.globtek.com 186 Veterans Drive, Northvale, NJ 07647 Tel. (201) 784-1000 Fax (201) 784-0111	Drawing Title: GT-86120-1005-W2U, ITE Power Supply, Efficiency Level: VI, Case Color/Style: GlobTek Black, Wall Plug-in, Regulated Switchmode AC-DC Power Supply AC Adaptor, Input Rating: 100-240V- , 50/60Hz, British Fixed , Output Rating: 10W, 5V@2A, Output Configuration: 1530 mm, 20/2 Cond, UL 2468, Female Barrel 5.5 * 2.5 * 11mm with internal Spring Clip and Locking Notch or Equal, Ferrite: None, GlobTek Black, GT Cord # C3262, Pin Out: Center Positive (+V), Blades/Input Cord: Fixed Blades UK, Approvals: WEEE; EAC; CB 60950; CE; China RoHS; cULus; Double Insulation; VCCI; Ukraine; SGS (GS); RoHS; PSE; LPS; Level VI; PSE;	
	Model No. GT-86120-1005-W2U	
	Part No./Ordering No. WR95A2000LCP-F(R6B)	Rev A1

## INPUT CONFIGURATION

(F1) Class II / Double Insulated

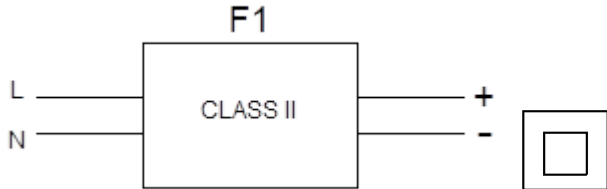

[Alternate grounding configurations](#) available upon request.

Blades/Cord Included:FBUK2:

Blades/Cord Installed:FBUK2:

UK BS 1363, 2 Blade w/Dummy Ground Class II

The line and neutral pins have a rectangular cross section 6.35 mm by 4.0 mm, 17.7 mm long and with centres 22.2 mm apart. The protective-earth pin is a rectangular cross section 8.0 mm by 4.0 mm, 22.3 mm long and with a centre line 22.2 mm from the line/neutral pin centre line. The dimensions were originally specified in decimal inches with asymmetric tolerances and redefined as minimum and maximum metric dimensions in BS 1363:1984.

Dimensions are chosen to provide safe clearance to live parts. The distance from any part of the line and neutral pins to the periphery of the plug base must be not less than 9.5 mm. This ensures that nothing can be inserted alongside a pin when the plug is in use, and helps keep fingers away from the pins. The minimum insertion distance from the face of the socket-outlet to the first point of contact with a live part is 9.6 mm.

The "Dummy" longer earth pin ensures that the earth path is connected before the live pins, and remains connected after the live pins are removed. The earth pin is too large to be inserted into the line or neutral sockets by mistake.

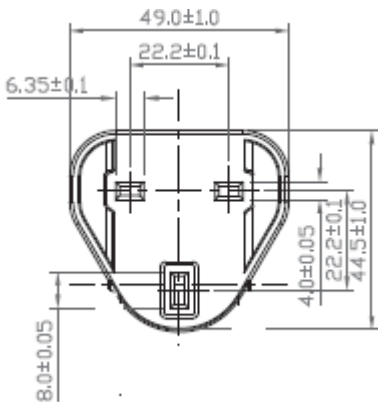

### PROPRIETARY INFORMATION

PROPRIETARY OF GLOBTEK, INC. ANY REPRODUCTION, DISCLOSURE OR USE OF THIS DRAWING, IN WHOLE OR IN PART, IS HEREBY PROHIBITED EXCEPT AS SPECIFIED IN WRITING BY GLOBTEK, INC. © GlobTek, Inc. 2017 - 2019

GlobTek, Inc. www.globtek.com 186 Veterans Drive, Northvale, NJ 07647 Tel. (201) 784-1000 Fax (201) 784-0111	Drawing Title: GT-86120-1005-W2U, ITE Power Supply, Efficiency Level: VI, Case Color/Style: GlobTek Black, Wall Plug-in, Regulated Switchmode AC-DC Power Supply AC Adaptor, Input Rating: 100-240V- , 50/60Hz, British Fixed , Output Rating: 10W, 5V@2A, Output Configuration: 1530 mm, 20/2 Cond, UL 2468, Female Barrel 5.5 * 2.5 * 11mm with internal Spring Clip and Locking Notch or Equal, Ferrite: None, GlobTek Black, GT Cord # C3262, Pin Out: Center Positive (+V), Blades/Input Cord: Fixed Blades UK, Approvals: WEEE; EAC; CB 60950; CE; China RoHS; cULus; Double Insulation; VCCI; Ukraine; SGS (GS); RoHS; PSE; LPS; Level VI; PSE;	
	Model No. GT-86120-1005-W2U	
	Part No./Ordering No. WR95A2000LCP-F(R6B)	Rev A1

OUTPUT CORD AND CONNECTOR: LCL/C3262

ACTUAL CONNECTORS, OVERMOLDS, FERRITES MAY VARY SLIGHTLY FROM THE PICTURE BELOW

CABLE TYPE	UL 2468
CABLE LENGTH (mm)	1530
CABLE TOLERANCE (mm)	± 100
WIRE GAUGE (AWG)	20
CONDUCTORS	2
HANK DIMENSION (mm)	70 ±10
CABLE / CONNECTOR OVERMOLD COLOR	GlobTek Black
FERRITE TYPE / DIMENSION	None
FERRITE # OF TURNS <a href="#">(Definition)</a>	N/A
FERRITE DIMENSION FROM STRAIN RELIEF	N/A
FERRITE DIMENSION FROM PLUG	N/A
PLUG TYPE	Female Barrel 5.5 * 2.5 * 11mm with internal Spring Clip and Locking Notch or Equal
OUTPUT CONNECTOR SEX	
OVERMOLDED	
OVER MOLD ORIENTATION	Straight
CONNECTOR PIN OUT:	Center Positive (+V)
ADDITIONAL REQUIREMENTS	

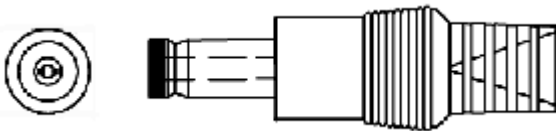

ADDITIONAL OUTPUT PLUG OPTIONS ARE AVAILABLE AT <https://www.globtek.com/connectors/>  
STANDARD PLUGS AND CONNECTORS CAN BE SEEN ONLINE AT <https://www.globtek.com/connectors/>

GlobTek, Inc. www.globtek.com 186 Veterans Drive, Northvale, NJ 07647 Tel. (201) 784-1000 Fax (201) 784-0111	Drawing Title: GT-86120-1005-W2U, ITE Power Supply, Efficiency Level: VI, Case Color/Style: GlobTek Black, Wall Plug-in, Regulated Switchmode AC-DC Power Supply AC Adaptor, Input Rating: 100-240V- , 50/60Hz, British Fixed , Output Rating: 10W, 5V@2A, Output Configuration: 1530 mm, 20/2 Cond, UL 2468, Female Barrel 5.5 * 2.5 * 11mm with internal Spring Clip and Locking Notch or Equal, Ferrite: None, GlobTek Black, GT Cord # C3262, Pin Out: Center Positive (+V), Blades/Input Cord: Fixed Blades UK, Approvals: WEEE; EAC; CB 60950; CE; China RoHS; cULus; Double Insulation; VCCI; Ukraine; SGS (GS); RoHS; PSE; LPS; Level VI; PSE;	
	Model No. GT-86120-1005-W2U	
	Part No./Ordering No. WR95A2000LCP-F(R6B)	Rev A1

LABEL:L-1186

LABEL P/N: Standard GT  
MATERIAL: Flat Thermal Transfer, Imprintable, Polyester Label and/or Pad Printed and/or Molded, and/or Laser Engraved in the case  
BACKGROUND COLOR: Black if housing is Black, White or Silver if housing is White or Gray.  
TEXT COLOR: White or Silver if label is Black Background for Black housing. Black if label is White or Silver background and Housing is White or Gray  
LABEL WIDTH (mm): 39.7  
LABEL HEIGHT (mm): 16.2  
SPECIAL BARCODE LABEL  
MATERIAL:

Below is the minimum information which will appear on the label. NOTE: in the logo area additional/actual positioning of symbols and text is subjected to change as per agency updates/requirements or additional model approvals become available.  
Regulatory certifications/label markings may be in logo area on the label or molded into the case housing outside the label area.  
Information will be shown via label and/or pad printed and/or molded and/or laser engraved in the case. \* Date code markings at GlobTek option.

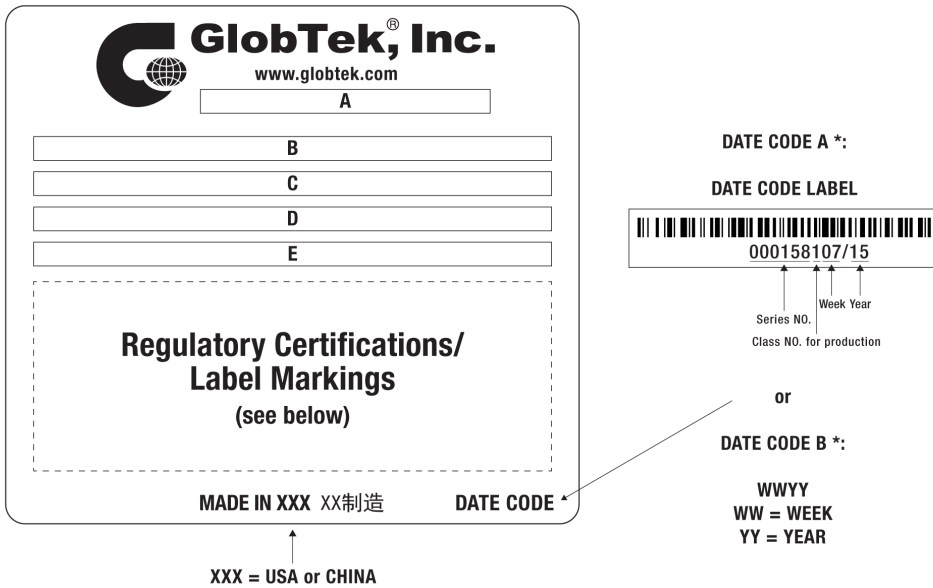

A=ITE Power Supply  
B=P/N: (料号) WR95A2000LCP-F(R6B)  
C=Model (型号) GT-86120-1005-W2U  
D=Input (输入) 100-240V- , 50/60Hz, 0.5A  
E=Output (输出) 5 V  $\equiv$  2 A, 10.0W



GlobTek, Inc. www.globtek.com 186 Veterans Drive, Northvale, NJ 07647 Tel. (201) 784-1000 Fax (201) 784-0111	Drawing Title: GT-86120-1005-W2U, ITE Power Supply, Efficiency Level: VI, Case Color/Style: GlobTek Black, Wall Plug-in, Regulated Switchmode AC-DC Power Supply AC Adaptor, Input Rating: 100-240V- , 50/60Hz, British Fixed , Output Rating: 10W, 5V@2A, Output Configuration: 1530 mm, 20/2 Cond, UL 2468, Female Barrel 5.5 * 2.5 * 11mm with internal Spring Clip and Locking Notch or Equal, Ferrite: None, GlobTek Black, GT Cord # C3262, Pin Out: Center Positive (+V), Blades/Input Cord: Fixed Blades UK, Approvals: WEEE; EAC; CB 60950; CE; China RoHS; cULus; Double Insulation; VCCI; Ukraine; SGS (GS); RoHS; PSE; LPS; Level VI; PSE;	
	Model No. GT-86120-1005-W2U	
	Part No./Ordering No. WR95A2000LCP-F(R6B)	Rev A1

AGENCY ONLINE DOCUMENTS

CE EC-Declaration for Medical

<http://www.globtek.info/certs/GT-86120-WVVV-W2Z/>

[Contact GlobTek for more information](#)

CE EC-Declaration for Industrial/Commercial/ITE

[http://globtek.force.com/models/ec\\_declaration?id=a0Oa000000jT6DEAV](http://globtek.force.com/models/ec_declaration?id=a0Oa000000jT6DEAV)

CE EC-Declaration for Household

[Contact GlobTek for more information](#)

RoHS/RoHS3 Declaration

[https://www.globtek.com/pdf/rohs\\_cert/01ta0000007dRJ3AAM](https://www.globtek.com/pdf/rohs_cert/01ta0000007dRJ3AAM)

REACH Declaration

[https://www.globtek.com/pdf/iso\\_certificates/REACH.pdf](https://www.globtek.com/pdf/iso_certificates/REACH.pdf)

Conflict Minerals Declaration

<https://www.globtek.com/pdf/conflict-minerals.pdf>

IPXY rating is based on 3rd party testing and customers should check suitability and test system level IPXY rating before ordering.

## Regulatory Certifications/Label Markings

LATEST PRODUCT/MODEL CERTIFICATIONS: <http://en.globtek.com/datasheet/id/a0Oa000000jT6D>

AGENCY ONLINE DOCUMENTS:

<http://www.globtek.info/certs/GT-86120-WVVV-W2Z/>



(F1) Class II / Double Insulated

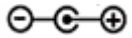

Center Positive (+V)

GlobTek, Inc. www.globtek.com 186 Veterans Drive, Northvale, NJ 07647 Tel. (201) 784-1000 Fax (201) 784-0111	Drawing Title: GT-86120-1005-W2U, ITE Power Supply, Efficiency Level: VI, Case Color/Style: GlobTek Black, Wall Plug-in, Regulated Switchmode AC-DC Power Supply AC Adaptor, Input Rating: 100-240V- , 50/60Hz, British Fixed , Output Rating: 10W, 5V@2A, Output Configuration: 1530 mm, 20/2 Cond, UL 2468, Female Barrel 5.5 * 2.5 * 11mm with internal Spring Clip and Locking Notch or Equal, Ferrite: None, GlobTek Black, GT Cord # C3262, Pin Out: Center Positive (+V), Blades/Input Cord: Fixed Blades UK, Approvals: WEEE; EAC; CB 60950; CE; China RoHS; cULus; Double Insulation; VCCI; Ukraine; SGS (GS); RoHS; PSE; LPS; Level VI; PSE;	
	Model No. GT-86120-1005-W2U	
	Part No./Ordering No. WR95A2000LCP-F(R6B)	Rev A1

## PACKAGING

Packing Spec P/N: Standard WPI non changeable, Individually Box, User manual  
Box Qty: 120  
Gift Box Size (mm): 90\*54\*76  
Gift Box Color: White  
Master Carton Size (mm): 470 x 345 x 340  
Master Carton Cubic Volume (m<sup>3</sup>): 0.06  
Master GW (Kg): 15.6 kg  
BLADES INCLUDED: FBUK2:  
BLADE/CORD INSTALLED: FBUK2:  
USER MANUAL: 809-DESKTOPUSERMANUAL on A4 paper  
USER MANUAL WEB LINK: <https://en.globtek.com/pdf/809-DESKTOPUSERMANUA...>

If specific packaging is required, this section must specify all requirements and note "no exceptions". If this section does not specify packaging, it is subject to change without notice at GlobTek's discretion

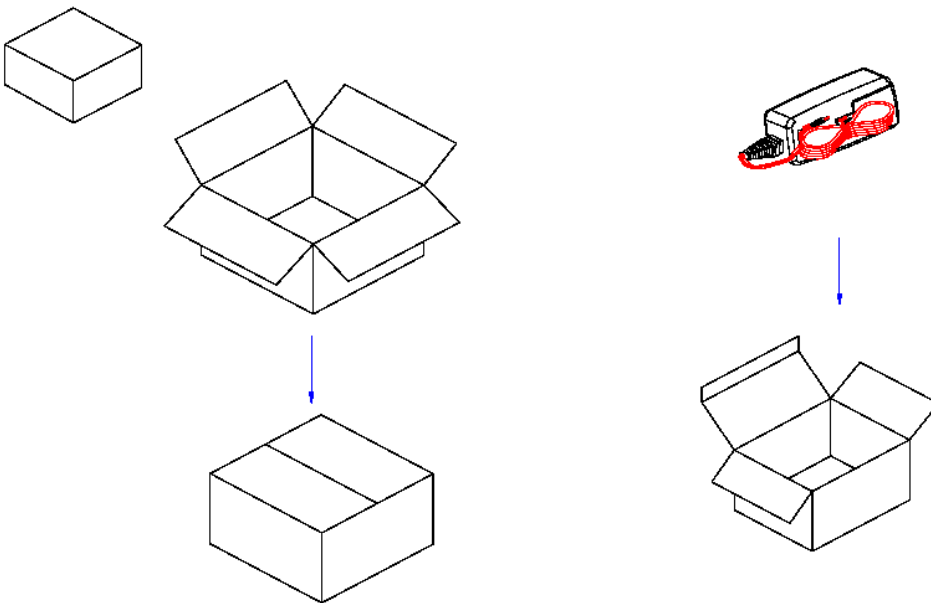

<p>GlobTek, Inc.  www.globtek.com  186 Veterans Drive,  Northvale, NJ 07647  Tel. (201) 784-1000  Fax (201) 784-0111</p>	<p>Drawing Title: GT-86120-1005-W2U, ITE Power Supply, Efficiency Level: VI, Case Color/Style: GlobTek Black, Wall Plug-in, Regulated Switchmode AC-DC Power Supply AC Adaptor, Input Rating: 100-240V- , 50/60Hz, British Fixed , Output Rating: 10W, 5V@2A, Output Configuration: 1530 mm, 20/2 Cond, UL 2468, Female Barrel 5.5 * 2.5 * 11mm with internal Spring Clip and Locking Notch or Equal, Ferrite: None, GlobTek Black, GT Cord # C3262, Pin Out: Center Positive (+V), Blades/Input Cord: Fixed Blades UK, Approvals: WEEE; EAC; CB 60950; CE; China RoHS; cULus; Double Insulation; VCCI; Ukraine; SGS (GS); RoHS; PSE; LPS; Level VI; PSE;</p>
	<p>Model No. GT-86120-1005-W2U</p>
	<p>Part No./Ordering No. WR95A2000LCP-F(R6B) <span style="float: right;">Rev A1</span></p>

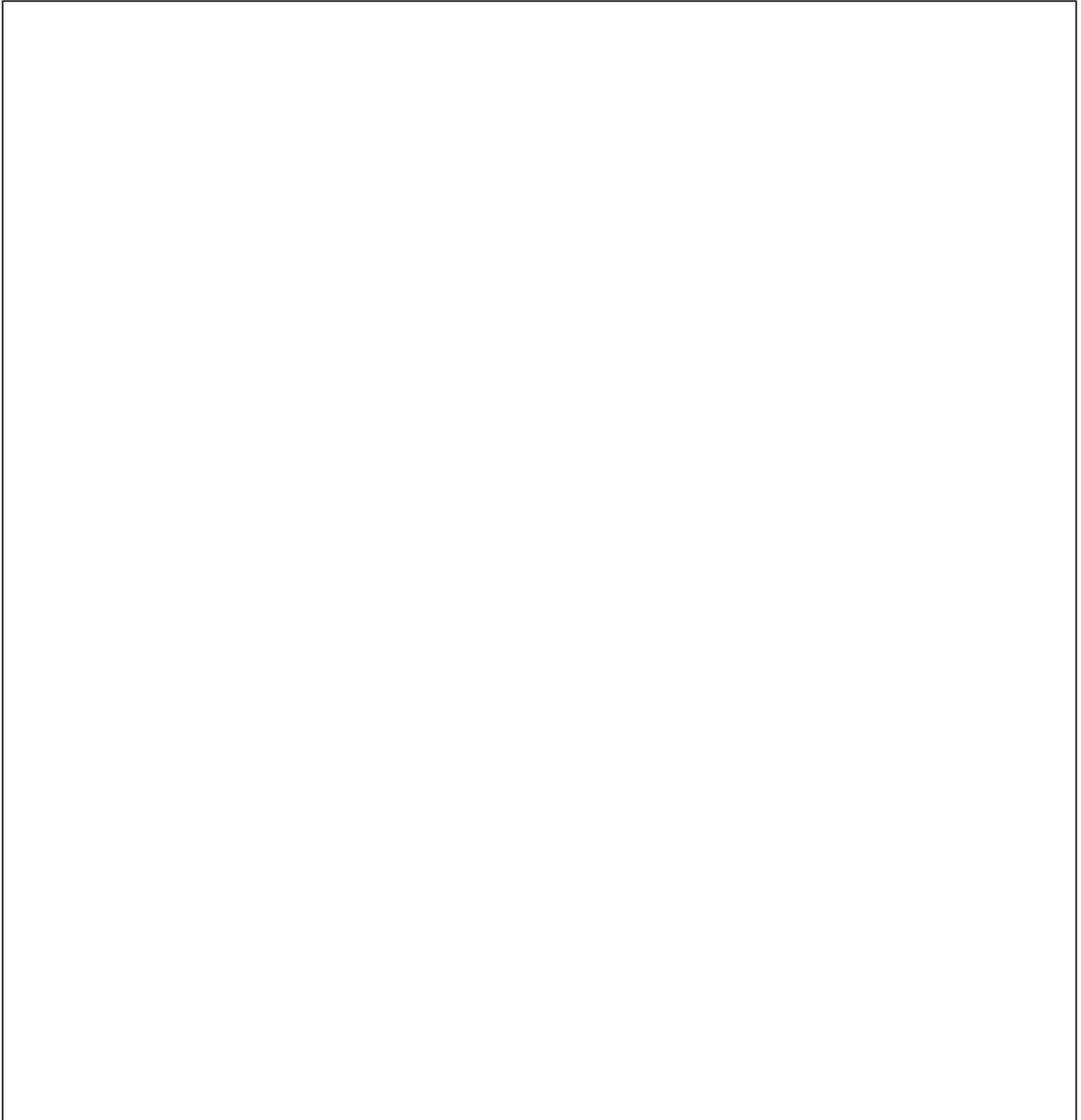

GlobTek, Inc. www.globtek.com 186 Veterans Drive, Northvale, NJ 07647 Tel. (201) 784-1000 Fax (201) 784-0111	Drawing Title: GT-86120-1005-W2U, ITE Power Supply, Efficiency Level: VI, Case Color/Style: GlobTek Black, Wall Plug-in, Regulated Switchmode AC-DC Power Supply AC Adaptor, Input Rating: 100-240V- , 50/60Hz, British Fixed , Output Rating: 10W, 5V@2A, Output Configuration: 1530 mm, 20/2 Cond, UL 2468, Female Barrel 5.5 * 2.5 * 11mm with internal Spring Clip and Locking Notch or Equal, Ferrite: None, GlobTek Black, GT Cord # C3262, Pin Out: Center Positive (+V), Blades/Input Cord: Fixed Blades UK, Approvals: WEEE; EAC; CB 60950; CE; China RoHS; cULus; Double Insulation; VCCI; Ukraine; SGS (GS); RoHS; PSE; LPS; Level VI; PSE;	
	Model No. GT-86120-1005-W2U	
	Part No./Ordering No. WR95A2000LCP-F(R6B)	Rev A1

## INSTRUCTIONS TO THE OEM SYSTEMS ENGINEER

It is the responsibility of the OEM systems engineer to provide the end system user instructions and warnings for the use of this product in the end system.

If an input cord is required for this product, AC Mains voltage should be provided to the power supply by a power supply cord approved to the national standards of the country in which it will be used.

This power supply is not designed to be repaired. No serviceable parts inside. A blown internal fuse is an indication of catastrophic failure of circuit component(s). If a Failure Analysis is required for a failed power supply/battery charger, please return the damaged unit to Globtek for an accurate determination of the root cause of the failure.

EMC Compliance of the complete OEM product, including the GlobTek power supply/battery charger needs to be verified by the OEM systems engineer.

## INSTRUCTION SHEET

N/A